

# システム別配線図

**J/B NO.1(右カウルサイド)**

電 源	負 荷	ページ	
7.5A	ラジオ	ラジオ & ステレオ(6スピーカー)	136
15A	エンジン	オルタネーター	20
7.5A	イグニッション	チャージウォーニングランプ	20
		メインリレー, エンジンコントロールコンピューター	22, 26, 32, 33, 44, 45, 46, 50, 51, 52, 56, 57, 58,
		エンジンコントロールコンピューター, VSV No.2, VSV(EGR), VSV No.1, VSV(吸気制御), フューエルカットソレノイド	62, 63
		エミッションコントロールコンピューター, VSV(フューエルカット), インジェクターリレー, インジェクター	66
		フューエルバルブソレノイド	68
		エンジンコントロールコンピューター	102
		コンビネーションメーター, 補助スピードメーター(教習車教官用)	138, 139
		コンビネーションメーター	142, 143
		ファンサブリレー, メインリレー, ファンメインリレー	146
		ラジエーターファンリレーNo.1, メインリレー(イグニッション), コンデンサーファンリレーNo.2	157, 158, 159, 160, 161
7.5A	スターター	コールドスタートインジェクター, スタートインジェクタータイムスイッチ	14
		サーキットオープニングリレー, エンジンコントロールコンピューター	22, 23, 26, 27, 32, 33, 38, 39, 44, 45, 50, 51, 56, 57
		スターターソレノイド, フューエルバルブコントロールリレー	66
		フューエルバルブコントロールリレー	68
		コンビネーションメーター	142, 143
		エアコンカットリレー	148, 151, 155, 157, 164, 170, 176,
20A	ワイパー	ウォッシャーモーター, ワイパーモーター, ワイパー & ウォッシャースイッチ(コンビスイッチ), ウインドウシールドワイパーリレー	90, 91
		ウォッシャーモーター, ウォッシャーチェンジバルブ, リヤワイパーモーターリレー, リヤワイパー & ウォッシャースイッチ	92
15A	エレクトロニクスB	コンライトスキャナー	72
		ESCコンピューター	111, 115
		トラクションコントロールコンピューター	122
		タクシー端子(料金メーター)	127
15A	エレクトロニクスIG	コンライトスキャナー	72
		ドアコントロールリレー	94
		パワーステアリングコンピューター	108
		ESCコンピューター	111, 115
		アブソルバーコントロールコンピューター, ステアリングセンサー, インジケーターランプ(コンビメーター)	119, 120
		トラクションコントロールコンピューター	122
		タクシー端子(タコグラフ)	127
		A/Dコンピューター	128
クリアランスウォーニングディスプレイ	133		
7.5A	ターン	ノイズフィルター, ターンシグナルランプ, ターンシグナルインジケーターランプ, ターンシグナルフラッシャー	84, 85

電 源		負 荷	ページ
15A	ストップランプ	エンジンコントロールコンピューター	28, 34, 35, 40, 41, 46, 47, 52, 53, 58, 59,
		ESCコンピューター	111, 115
		アブソバーコントロールコンピューター	120
		トラクションコントロールコンピューター	122
		A/Dコンピューター	129
15A	フォグランプ	フォグランプ	87
7.5A	メーター	チェックエンジンウォーニングランプ, 排気温ウォーニングランプ, スーパーチャージャーインジケータースランプ(IG-GZE), ターボインジケータースランプ(IG-GTE)	23, 28, 34, 35, 40, 41, 47, 53, 59,
		グローインジケータースランプ, タコメーター	63
		排気温ランプ	66
		バックアップランプ	88
		O/D OFFインジケータースランプ	102, 103, 106
		トランスミッションインジケータースランプ	102, 103, 105
		エンジンコントロールコンピューター	102
		O/Dリレー, O/Dソレノイド	106
		ESCコンピューター, ブレーキウォーニングランプ, ESCインジケータースランプ	110, 111, 114, 115
		TRC OFFインジケータースランプ, TRCインジケータースランプ, トラクションコントロールコンピューター	123
		A/Dインジケータースランプ	128, 129
		クリアランスウォーニングコンピューター	132
		コンビネーションメーター	138, 139, 142, 143
		レオスタット	142, 143
		ヒーターリレー	148, 151, 155, 161, 167, 173, 185
システムアンプ, モードコントロールサーボ, エアインレッドサーボ, ヒーターコントロール & エアコンスイッチ	157, 158, 159, 160, 164, 165, 166, 167, 170, 171, 172, 173, 176, 177, 178, 179		
ブLOWER運動リレー, ブLOWERハイリレー	176, 177, 178, 179		
15A	テールランプ	エンジンコントロールコンピューター	34, 35, 40, 41, 102, 103
		クリアランスランプ, ランプフェイリアセンサー, テールランプ, ライセンスプレートランプ	74, 75
		シガレットライター照明, グローボックスランプ, ステップランプ, サブメーター照明, A/Tインジケータースランプ, ハザードスイッチ照明, コンビメーター照明, トランスミッションインジケータースランプ, デフォッガースイッチ照明, パターンセレクトスイッチ照明, アブソバーコントロールスイッチ照明, ラジオ照明, エアコンスイッチ照明, ヒーターコントロールスイッチ照明, エアビュリファイアースイッチ照明,	80, 81, 82
		フォグランプリレー	87
		タクシー端子(料金メーター), タクシー端子(タコグラフ)	127
		クリアランスウォーニングコンピューター	132, 133
		レオスタット	143



# 電源(電源一負荷)

## J/B NO.1(右カウルサイド)

電 源	負 荷	ページ	
30 A	C/Bパワー	ドアコントロールスイッチ, パワーウィンドウモーター, ドアコントロールリレー	94, 95
		メインリレー	98
20 A	C/Bドアロック	ドアコントロールリレー	98

## J/B NO.2(エンジンルーム)

15 A	ヘッドランプ(右)	ヘッドランプ(RH)	70
15 A	ハザード・ホーン	ノイズフィルター	84
15 A	ヘッドランプ(左)	ヒューズ電気負荷アイドルアップ(R/B No.4)	69
		ヘッドランプLH	70
15 A	AM2	イグニッションスイッチ(AM2)	12
20 A	ルームランプ	エンジンコントロールコンピューター	63
		マップランプ, ルームランプ, ドアカーテシスイッチ, イグニッションキー照明, 半ドアウォーニングランプ, インテグレーションリレー, ラグゲージルームランプ	76, 77
		ドアコントロールレシーバー(ワイヤレスドアロック付き)	98, 99
		ラジオ & ステレオ(6スピーカー)	136
		コンビネーションメーター	142, 143
20 A	EFI	エンジンコントロールコンピューター, サーキットオープニングリレー, フューエルポンプ, ダイアグノーシスコネクター, アイドルスピードコントロールバルブ(1G-FE, 1G-GTE), ISCステップモーター(1G-GE, 1G-GZE, 7M-GE), VSV(T-VIS)(1G-GE), スーパーチャージャーリレー(1G-GZE), スーパーチャージャーマグネットクラッチ(1G-GZE), VSV1(1G-GZE), VSV2(1G-GZE), VSV(EPU)(1G-GTE), VSV(7M-GE), O <sub>2</sub> センサー(1G-GTE), フューエルポンプリレー(1G-GZE, 1G-GTE, 7M-GE), フューエルポンプレジスター(1G-GZE, 1G-GTE, 7M-GE)	22, 23, 26, 27, 32, 33, 38, 39, 40, 44, 45, 46, 50, 51, 52, 56, 57, 58
		エンジンコントロールコンピューター	102

## R/B NO.4(左カウルサイド)

10 A	電気負荷アイドルアップ	アイドルアップダイオード	69
10 A	エアコン	ブLOWERモーター	147, 151, 155
		ヒーターコントロール & エアコンスイッチ, エアコンアンブ, マグネットクラッチ, マグネットクラッチリレー, コンデンサーファンリレーNo.3(4S-Fi Eグレード), コンデンサーファンリレー	159, 160, 161, 173, 179
		ヒーターコントロール & エアコンスイッチ, マグネットクラッチリレー, マグネットクラッチ, コンデンサーファンリレー	167
40 A	C/Bヒーター	ブLOWERモーター, ヒューズエアコン, エアコンアンブ, マグネットクラッチリレー, マグネットクラッチ, コンデンサーファンリレー, VSV(アイドルアップ)(3Y-P)	146, 147, 148, 150, 151, 154, 155
		ブLOWERモーター, ヒューズエアコン, ヒーターコントロール & エアコンスイッチ, エアコンアンブ, マグネットクラッチ, マグネットクラッチリレー, コンデンサーファンリレーNo.3(4S-Fi Eグレード), コンデンサーファンリレー	157, 158, 159, 160, 161, 164, 165, 166, 167, 170, 171, 172, 173
		ブLOWERモーター, ヒューズエアコン, ヒーターコントロール & エアコンスイッチ, エアコンアンブ, マグネットクラッチリレー, マグネットクラッチ	176, 177, 178, 179

## ヒューズブルリンクボックス(エンジンルーム)

電 源		負 荷	ページ
10A	アイドルアップ	アイドルアップダイオード	69
60A	ESC	ESCアクチュエーター(トラクションコントロールなし)	110
		ESCリレー(トラクションコントロール付き)	114
30A	ラジエーターファン	ヒューズファンアイドルアップ(FLボックス)	69
		ラジエーターファンモーター, ファンメインリレー	146
		ラジエーターファンモーター, コンデンサーファンリレーNo.2	161
100A 80A (注1)	オルタ	C/Bデフォッガー, ヒューズストップランプ, ヒューズエレクトロニクスB, C/Bヒーター, ヒューズフォグランプ, ヒューズテールランプ, テールランプリレー, FL AM1, FLコンデンサーファン, FL ESC, FLトラクションコントロール	12
		オルタネーター(ICレギュレータ付き)(除く3Y-P)	20
30A	コンデンサーファン	コンデンサーファンモーター, コンデンサーファンモーターNo.2(O, V, Zグレード)	146, 150, 154, 161, 167, 173, 179
30A	トラクションコントロール	トラクションリレー	123
40A	AM1	C/Bドアロック, イグニッションスイッチ(AM1), C/Bパワー	12
		スターター, ヒューズスターター	14
		オルタネーター(ICレギュレータ付き)	20
30A	AM2	イグニッションスイッチAM2	12
		イグニッションコイル(ガソリン除く1G-FE, 1G-GTE), イグナイター(ガソリン除く1G-FE, 1G-GTE), イグニッションコイル & イグナイター(1G-FE, 1G-GTE), コンデンサー(ラジオ)	14, 15, 16, 17

## ヒューズブルリンク(バッテリー横)

2.0L 3.0W (注2)	メイン	FLオルタ, FL AM2, ヒューズAM2(ディーゼル), FLグロー(ディーゼル), ヒューズEFI(ガソリン), ヒューズルームランプ, ヒューズハザード・ホーン, ヒューズテレホン, ヘッドランプリレー, ヒューズヘッドランプ(右), ヒューズヘッドランプ(左), ヒューズフューエルヒーター(ディーゼル)	12
----------------------	-----	---	----

(注1) 100A : 除く3Y-P教習車 80A : 3Y-P教習車

(注2) 2.0L : M/T, 3Y-P 3.0W : 除くM/T, 3Y-P



# 電源

⊙トラクションコントロールなし  
 △トラクションコントロール付き

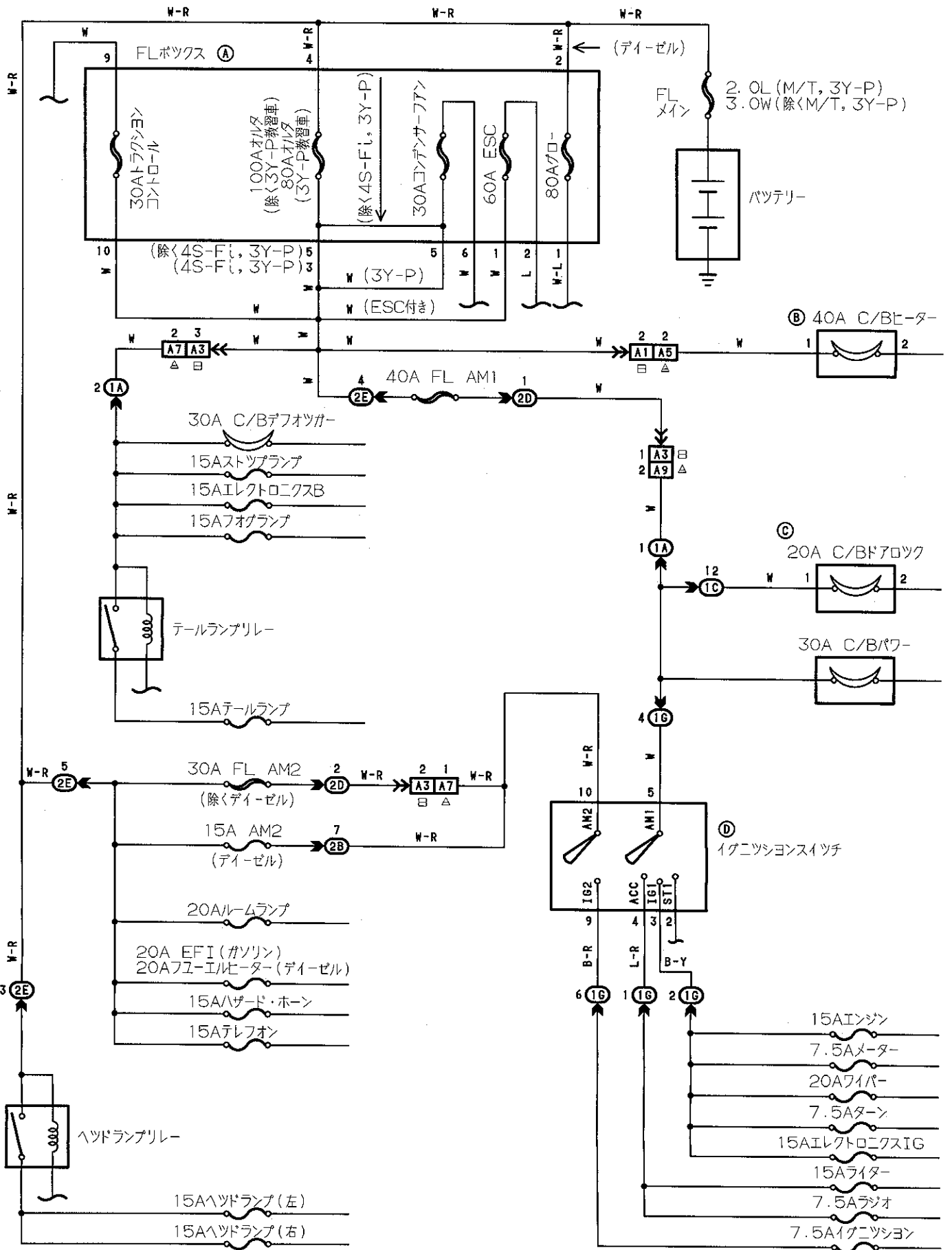

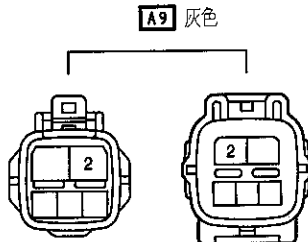
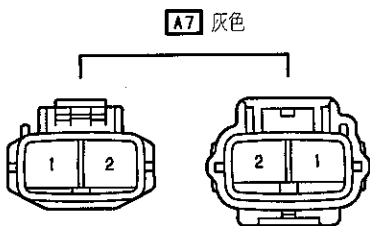
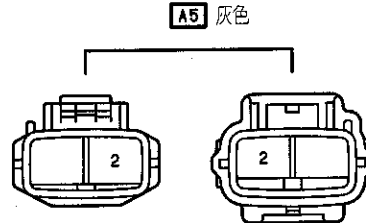
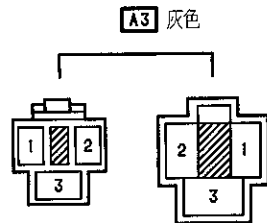
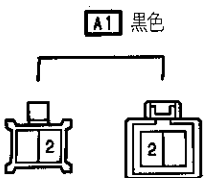
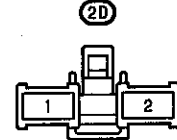
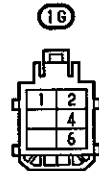
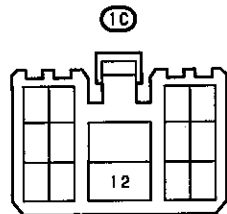
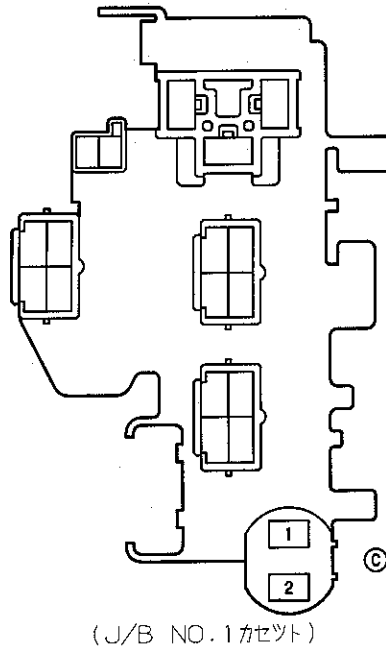
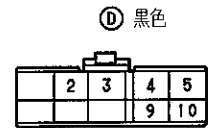
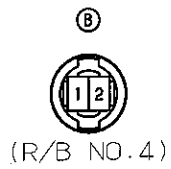
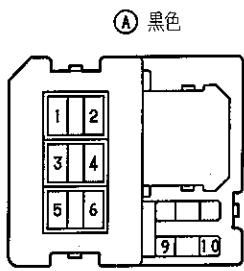



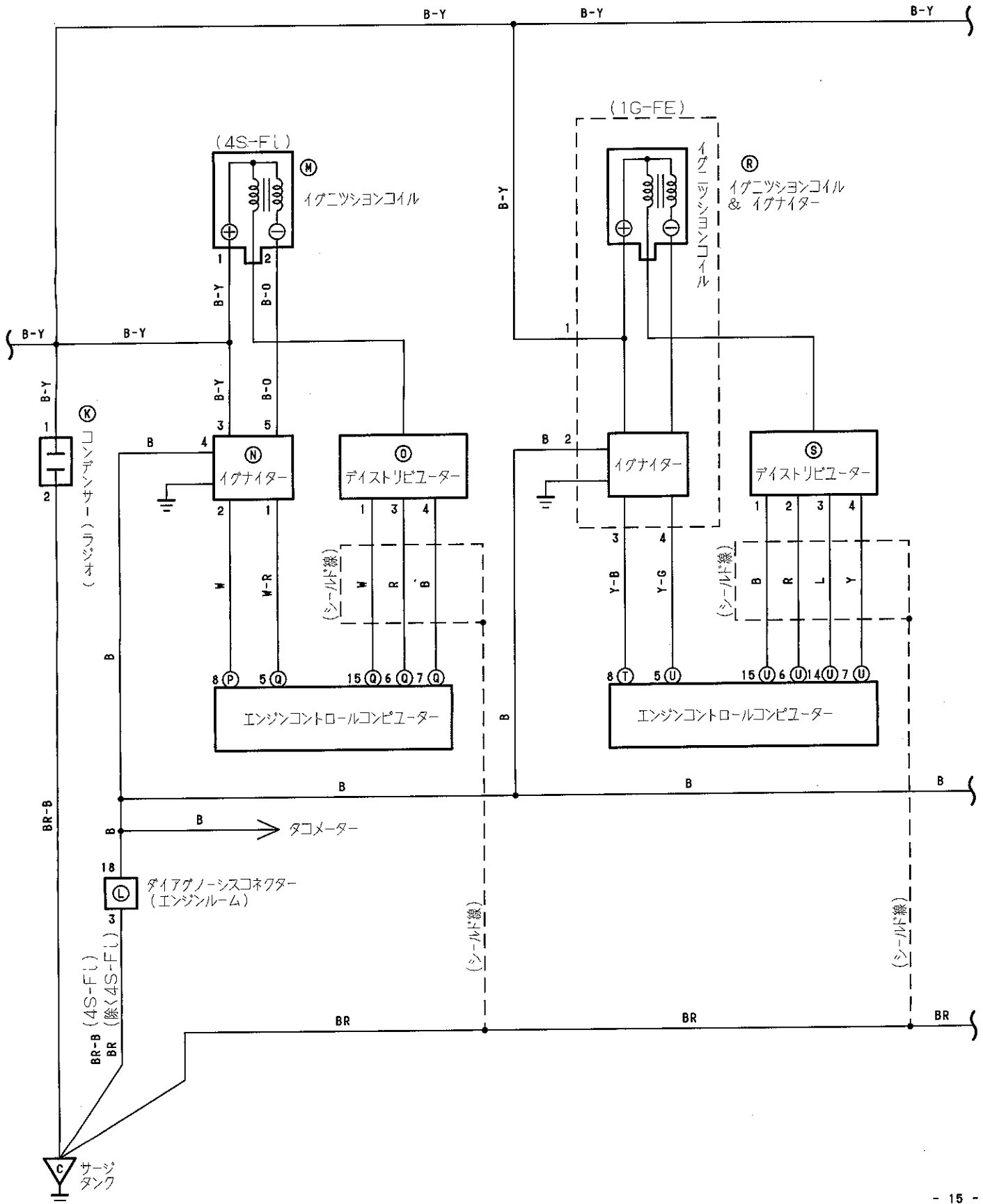



# スターティング & イグニッション(ガソリン)

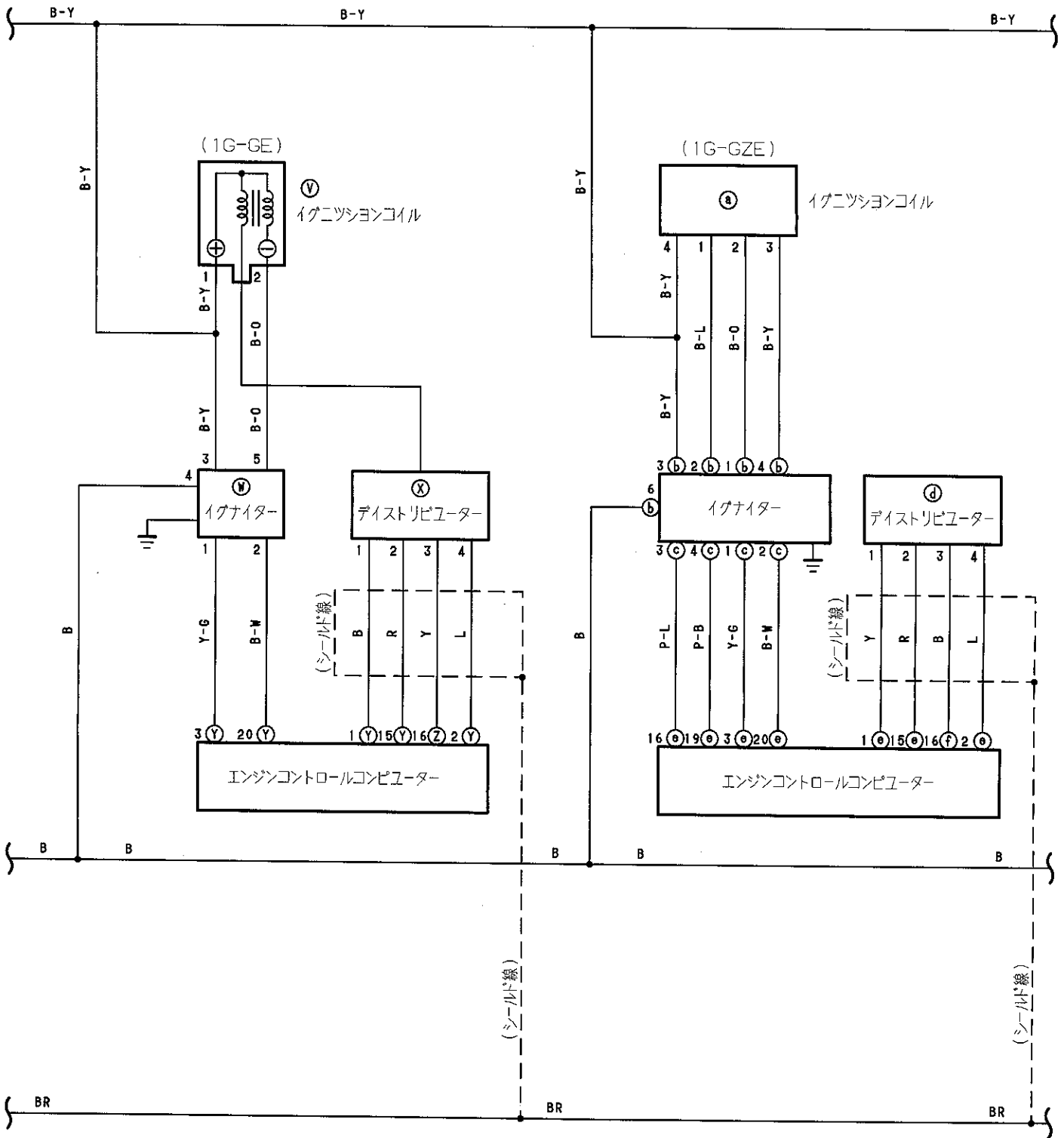

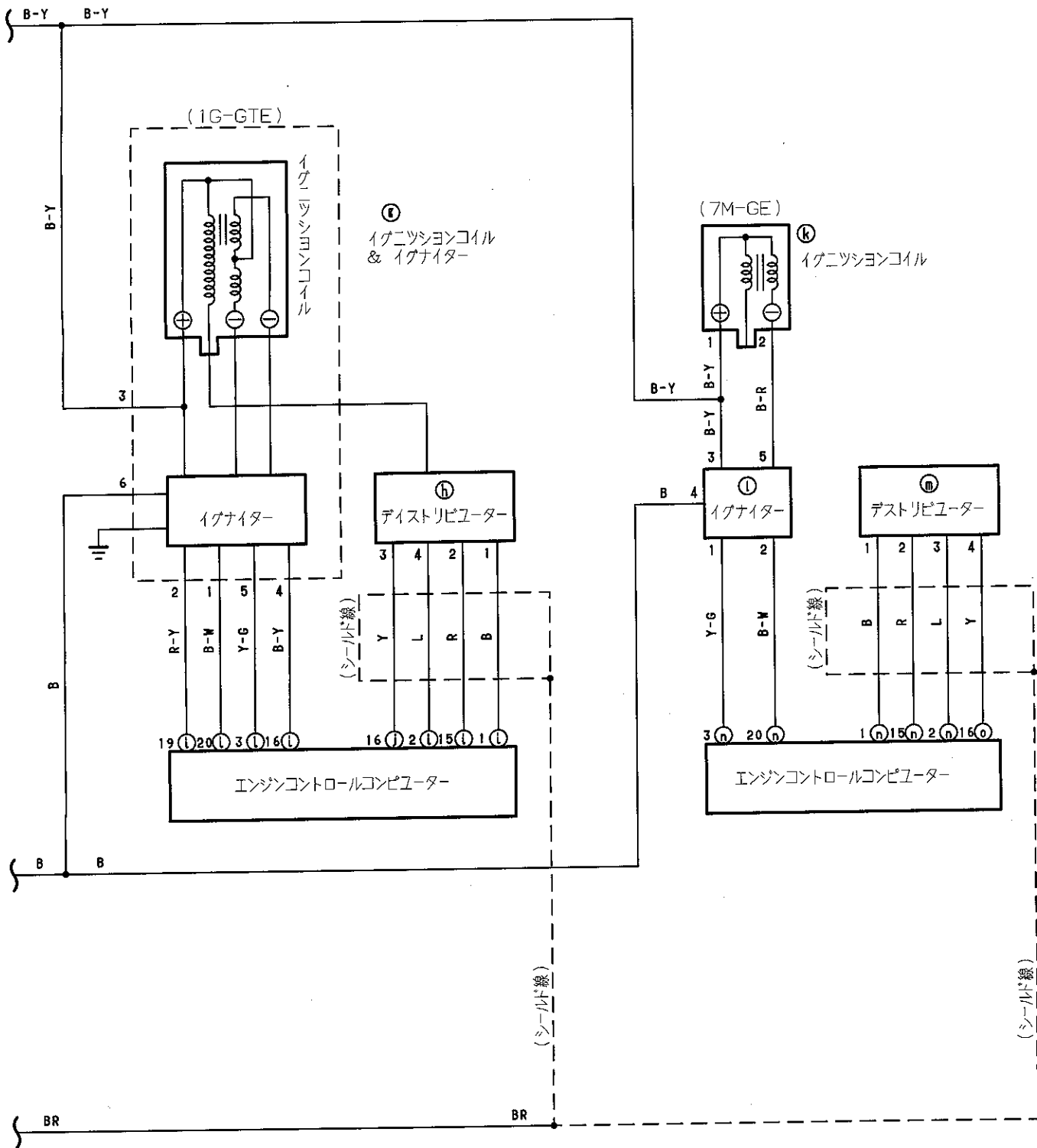



# スターティング & イグニツション(ガソリン)

Ⓐ 黒色

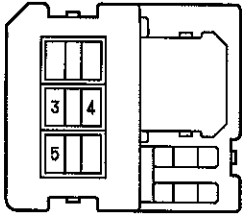

Ⓑ 黒色

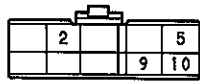

Ⓒ 灰色

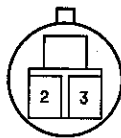

Ⓓ 濃灰色



Ⓔ 濃灰色



Ⓕ

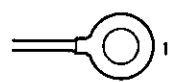

Ⓖ 茶色



Ⓕ 濃灰色



Ⓖ 黒色

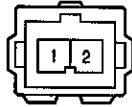

Ⓖ 濃灰色



Ⓖ 灰色



Ⓖ 濃灰色

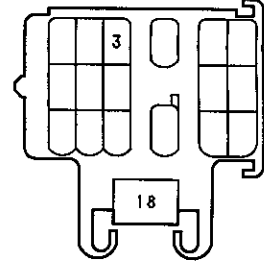

Ⓜ Ⓟ 黒色



Ⓝ Ⓞ 黒色



Ⓞ Ⓟ Ⓜ 黒色

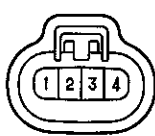

Ⓟ 濃灰色

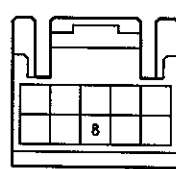

Ⓞ 濃灰色

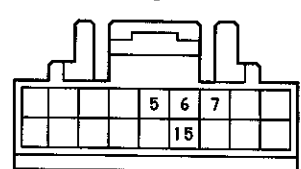

Ⓡ Ⓧ Ⓢ Ⓣ Ⓝ Ⓞ 濃灰色



Ⓝ 濃灰色

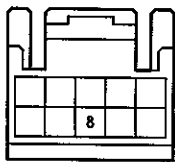

Ⓝ 濃灰色

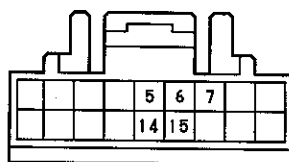

Ⓝ Ⓞ 濃灰色

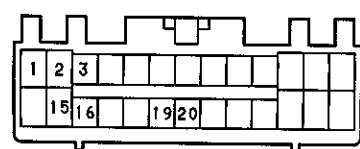

Ⓝ Ⓞ Ⓟ 濃灰色

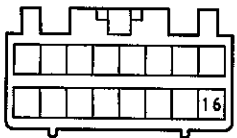

Ⓞ Ⓟ 濃灰色

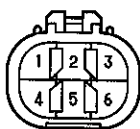

Ⓞ 濃灰色



Ⓝ Ⓞ 濃灰色

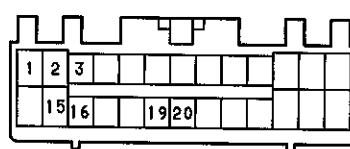

Ⓝ 濃灰色

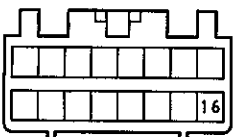

Ⓞ 黒色



Ⓝ 黒色



Ⓞ 茶色



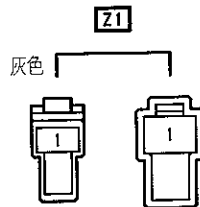
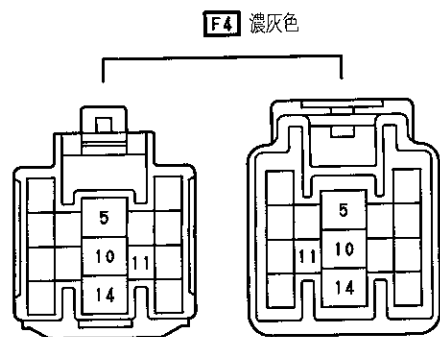
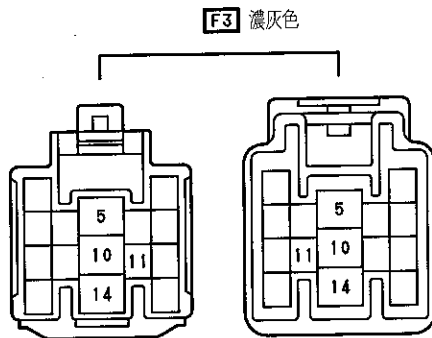
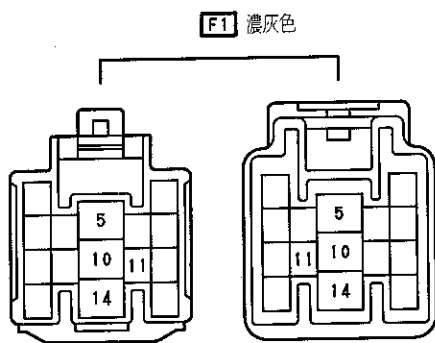
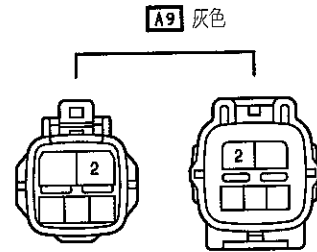
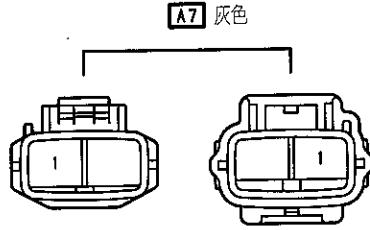
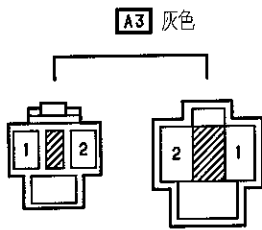
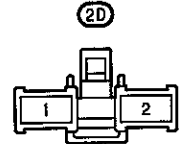
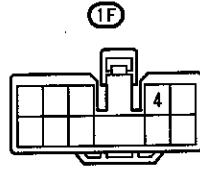
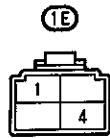
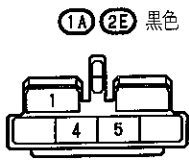



# 充電

□ トラクションコントロールなし  
 △ トラクションコントロール付き

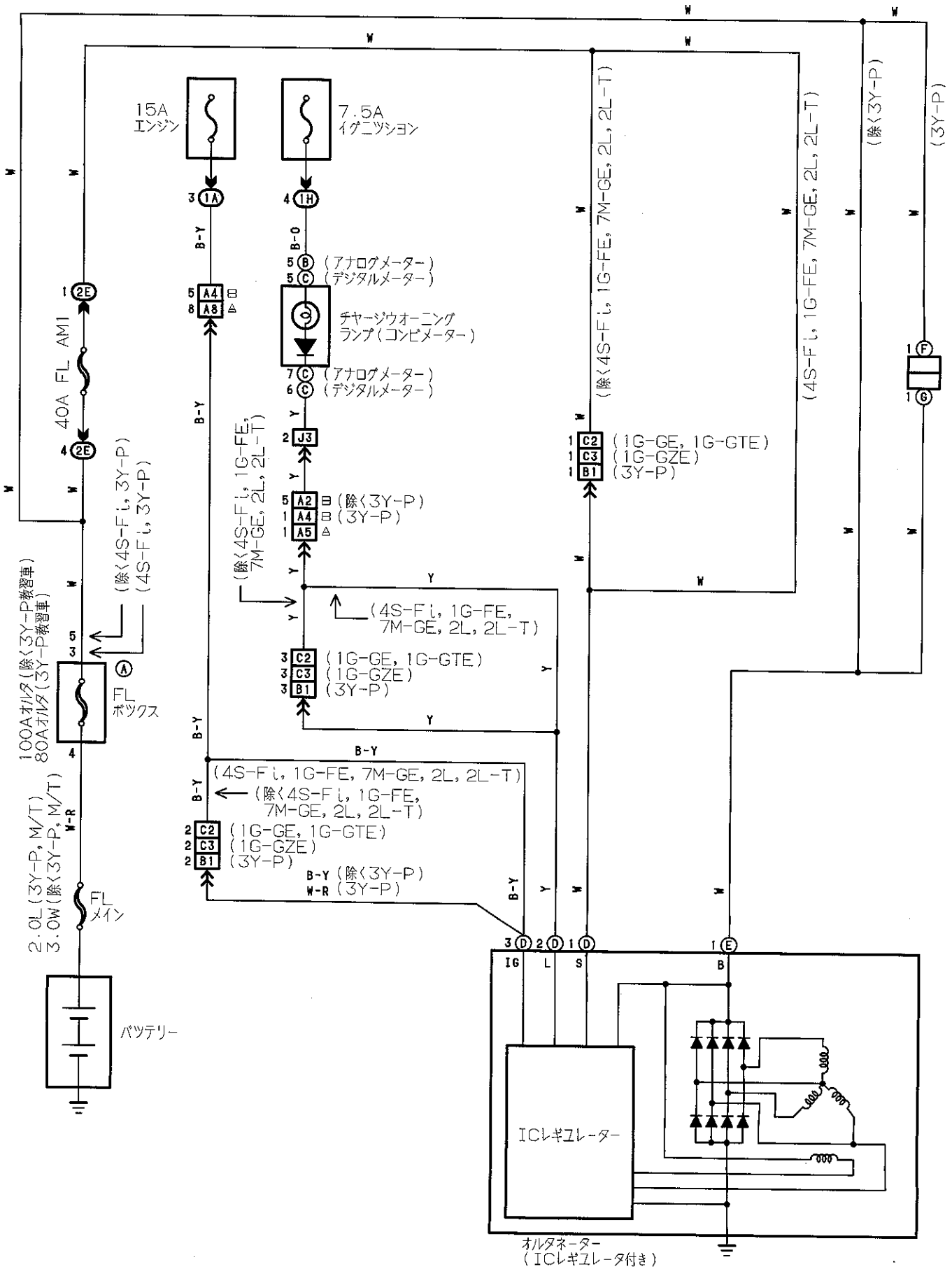

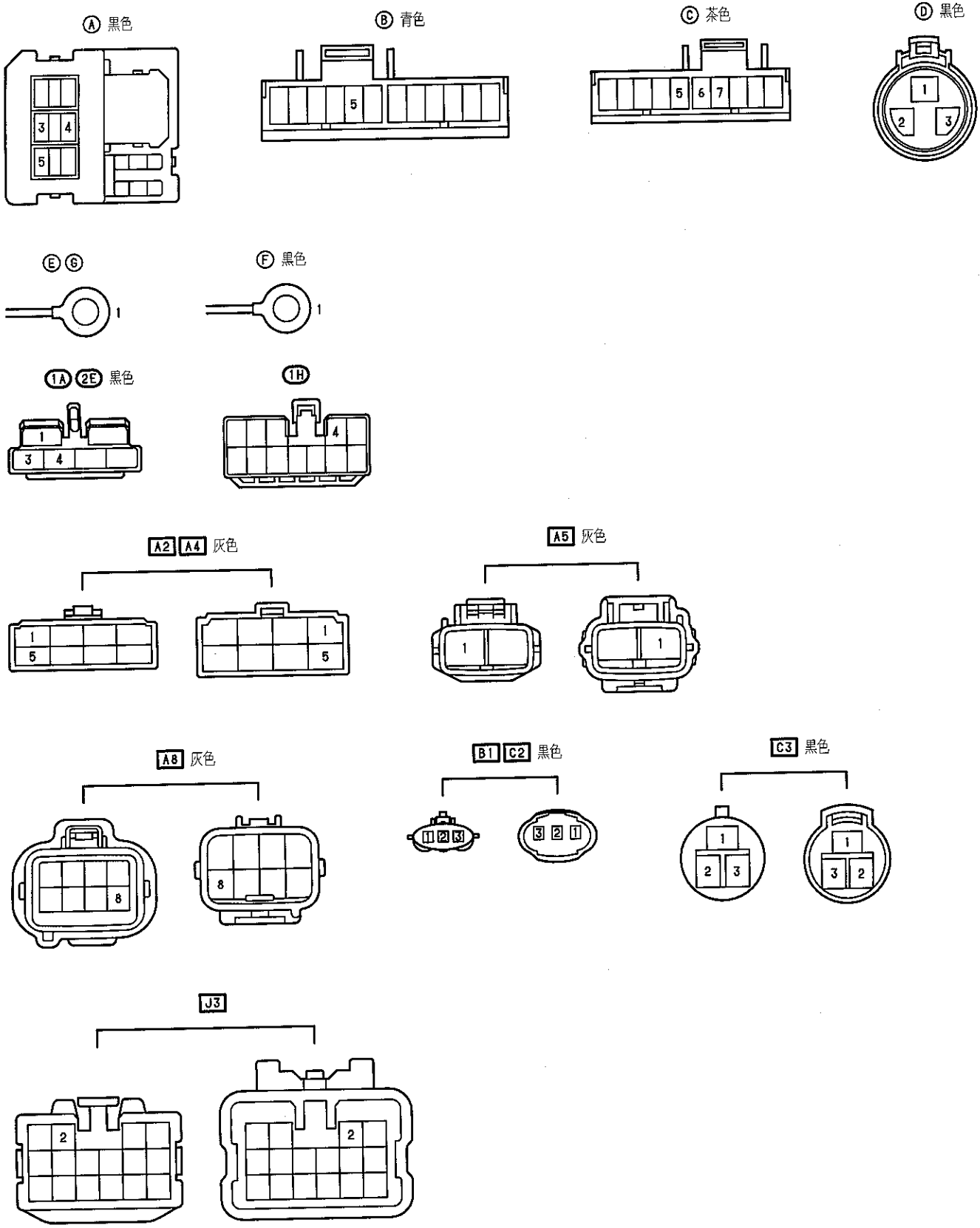



# EFI (4S-FI)

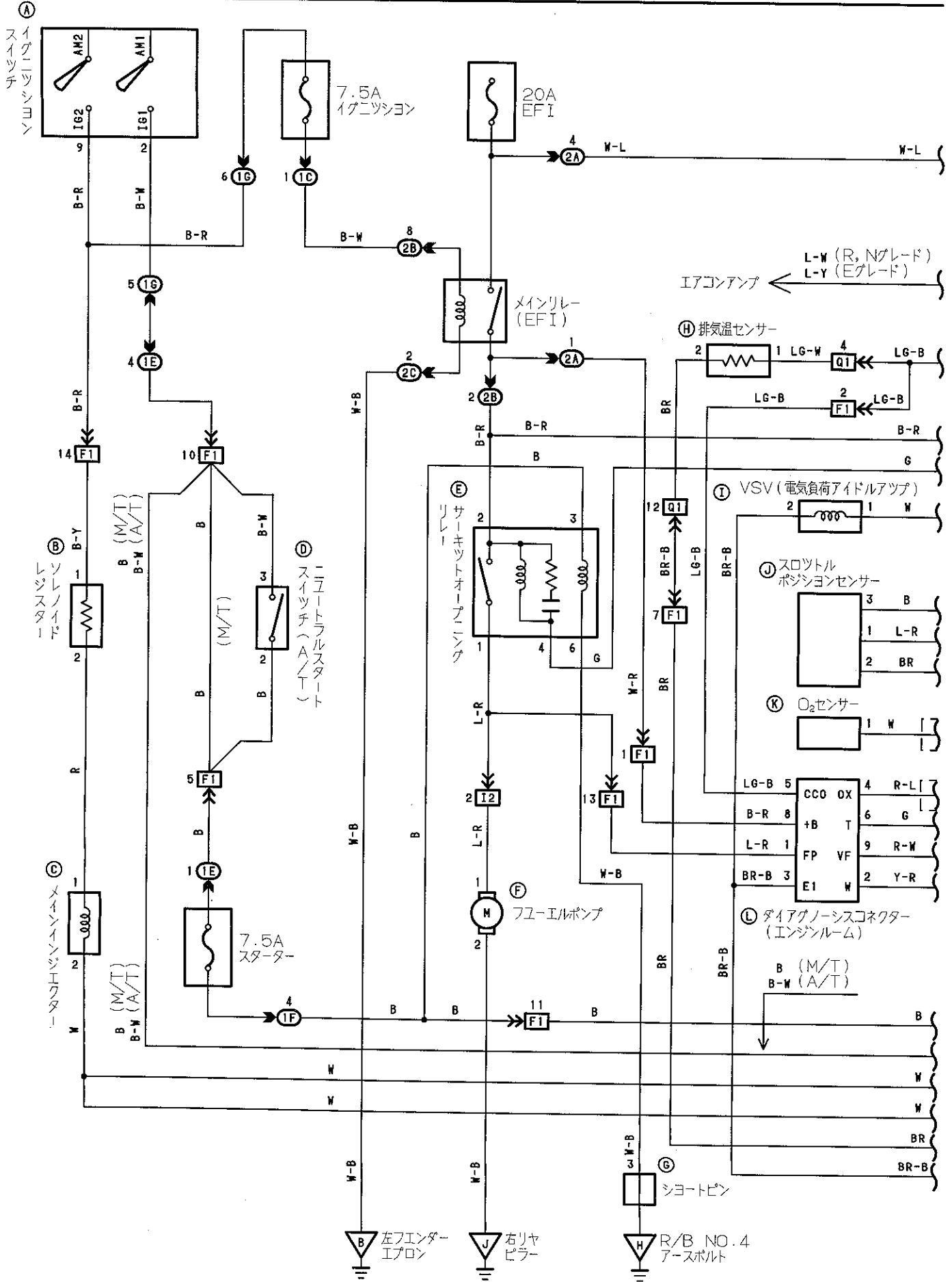

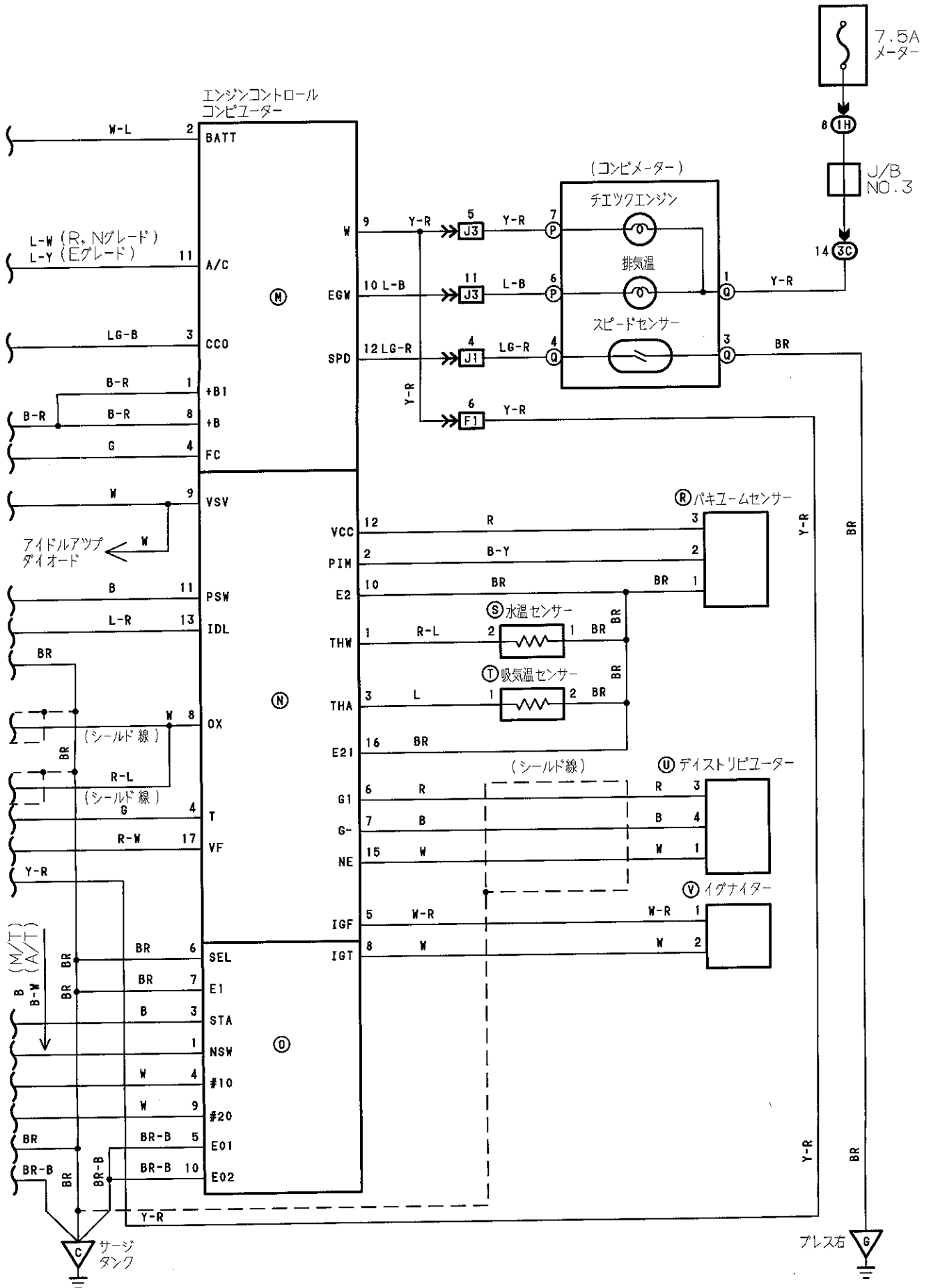

# EFI (4S-Fi)

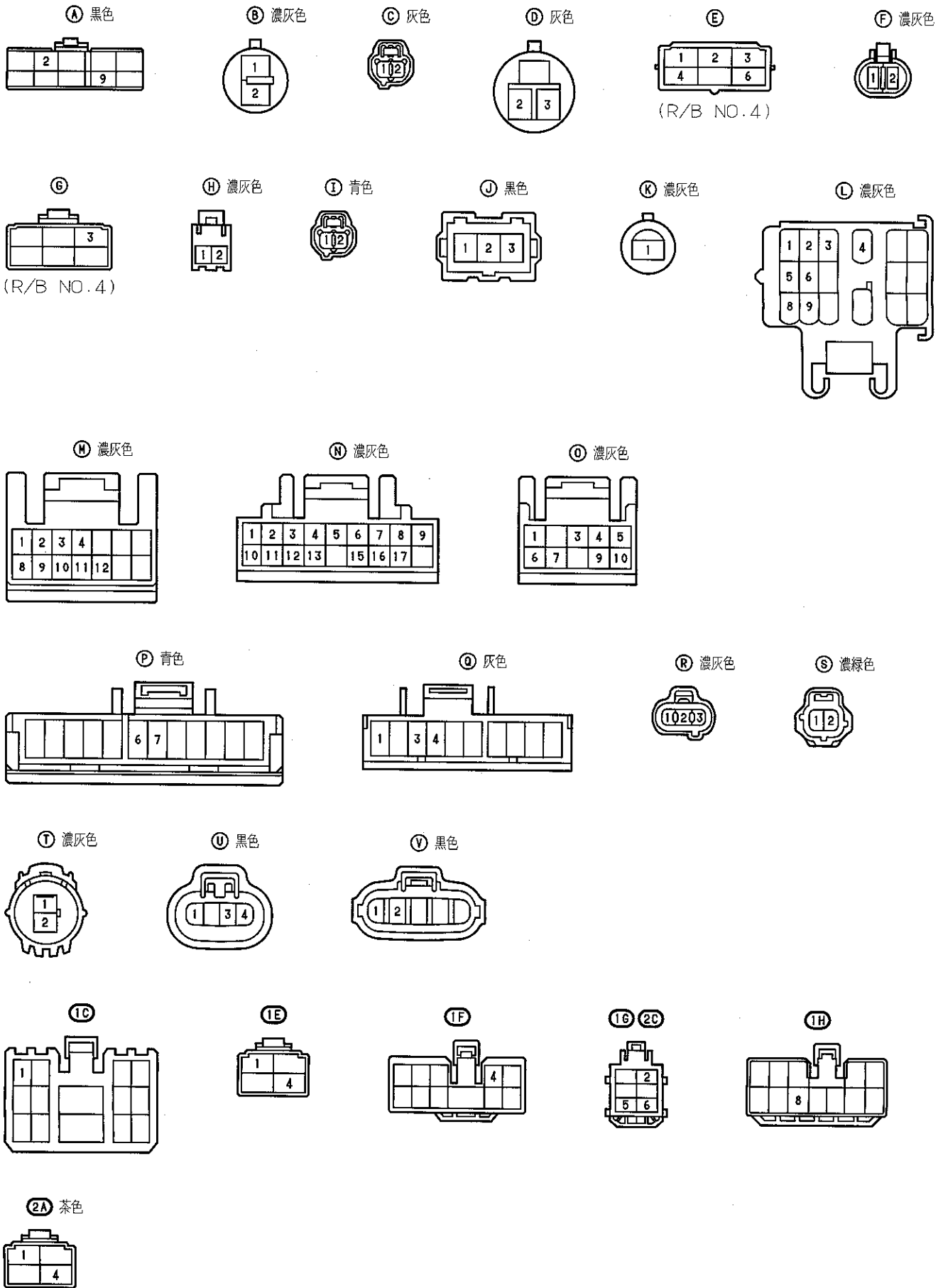

②B 黑色

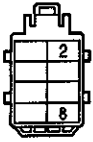

③C 青色

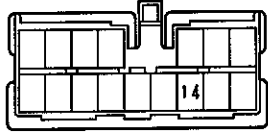

F1 濃灰色

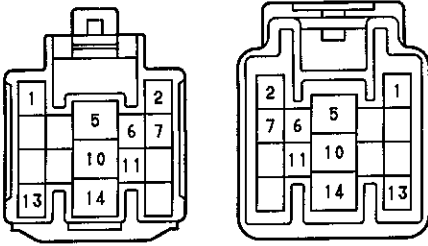

I2

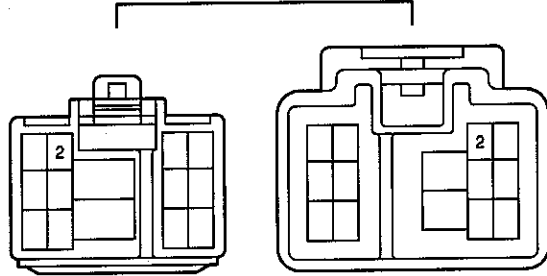

J1 J3

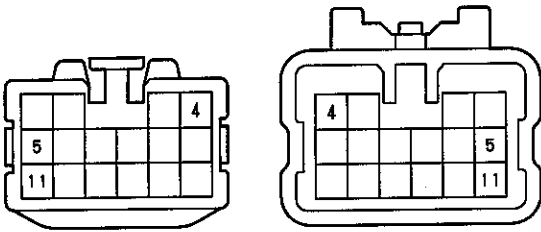

Q1

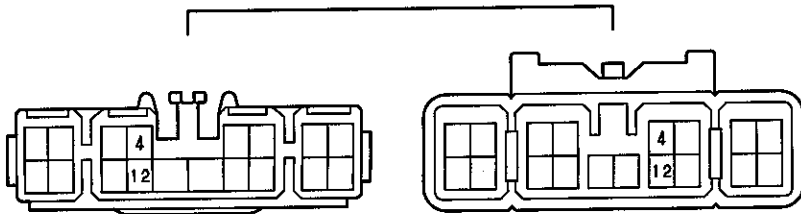

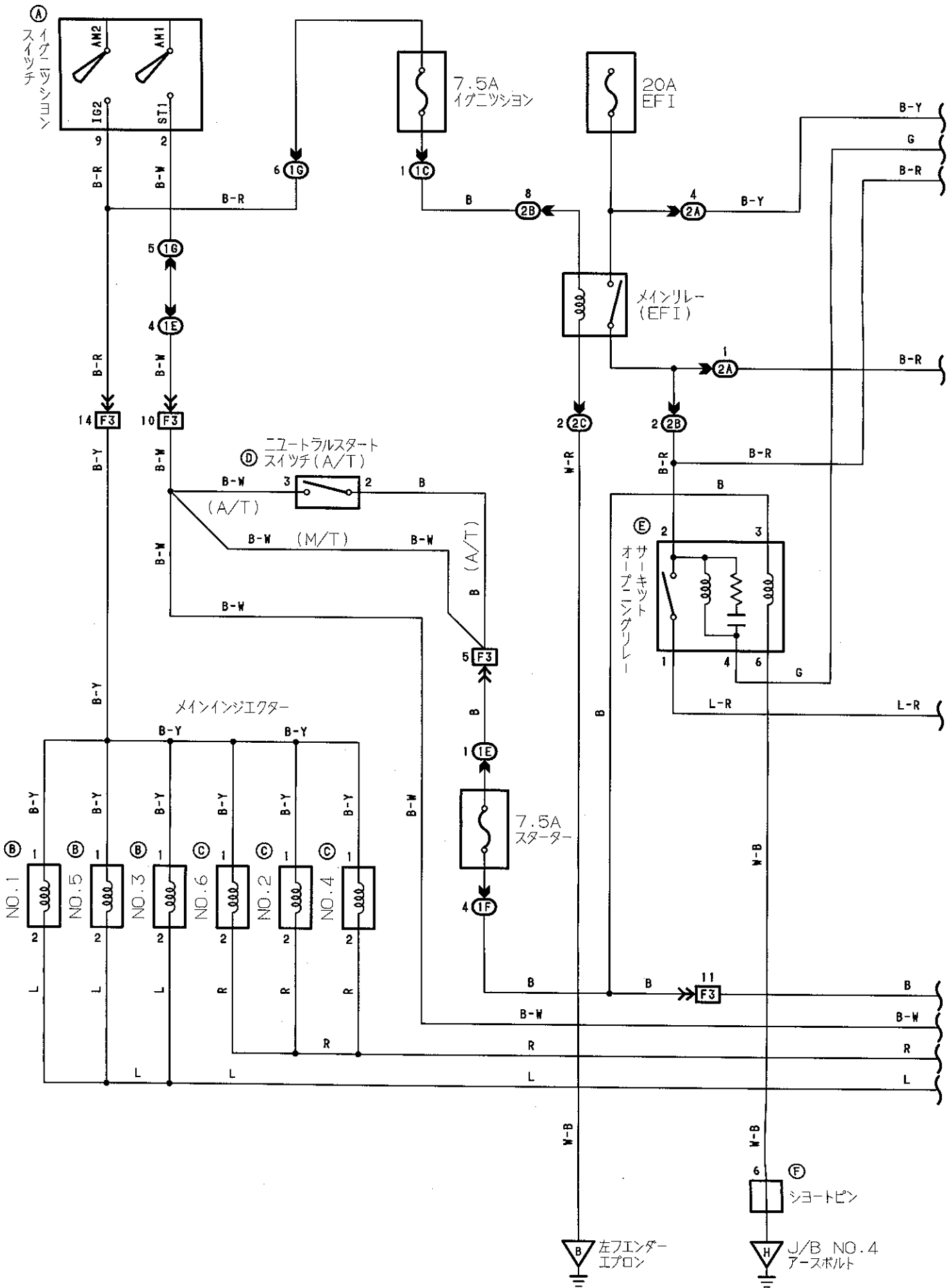

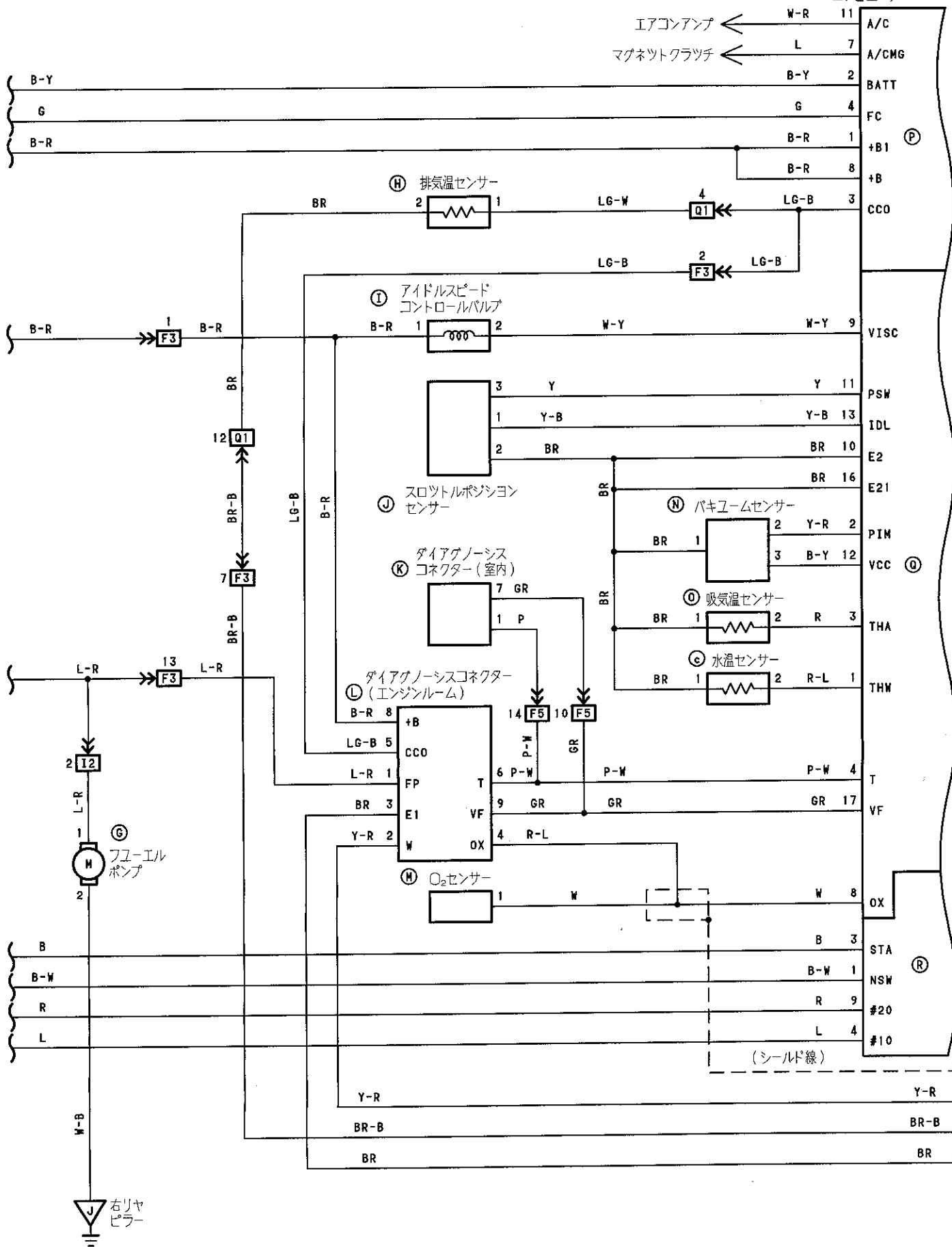



# EFI (1G-FE)

エンジンコントロール  
コンピューター

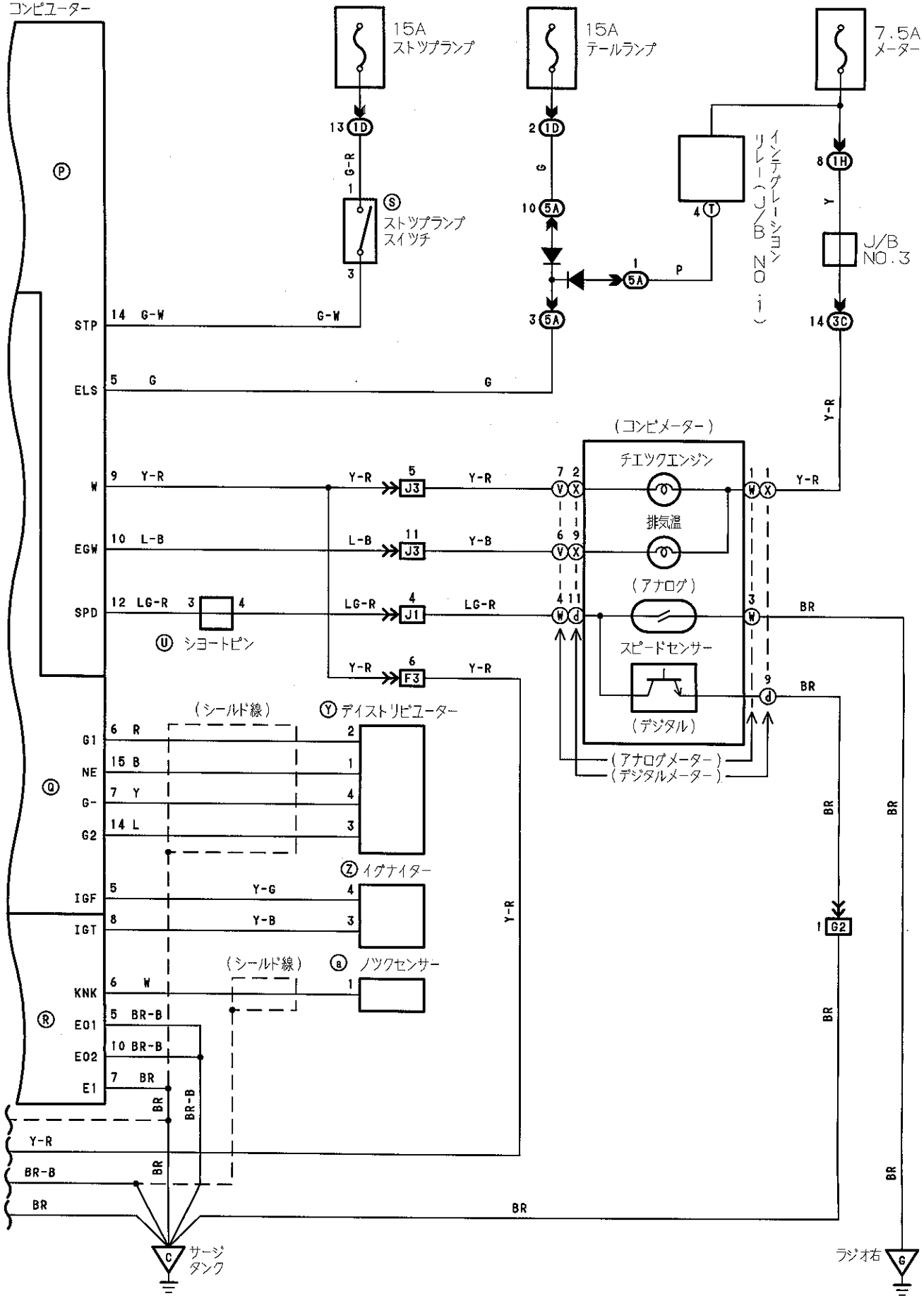

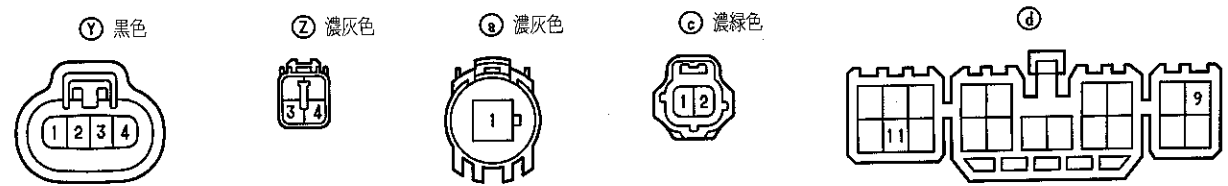
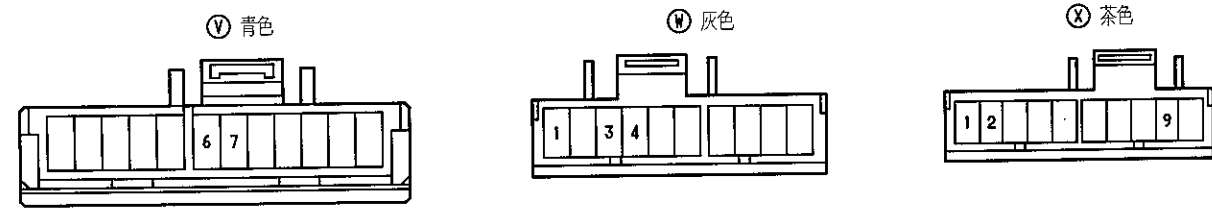
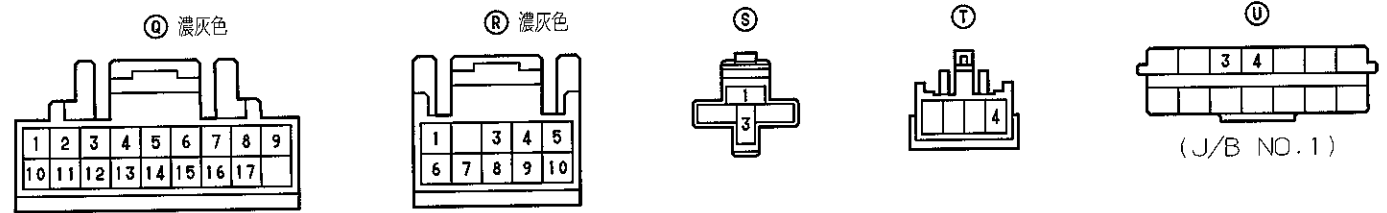
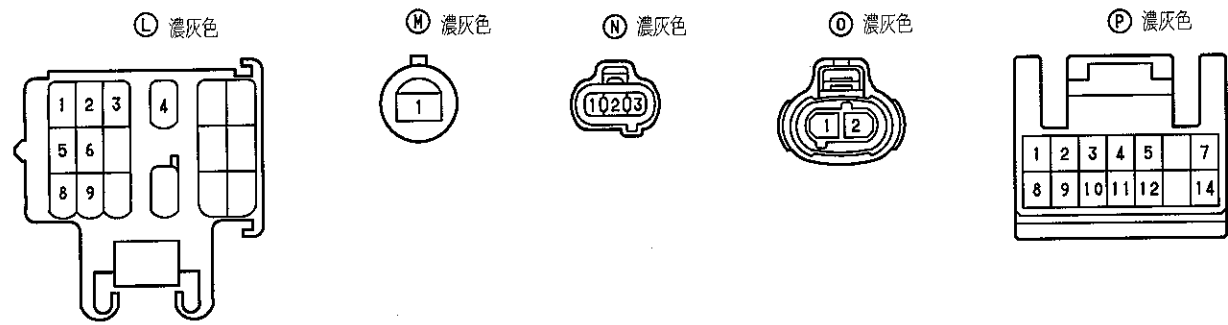
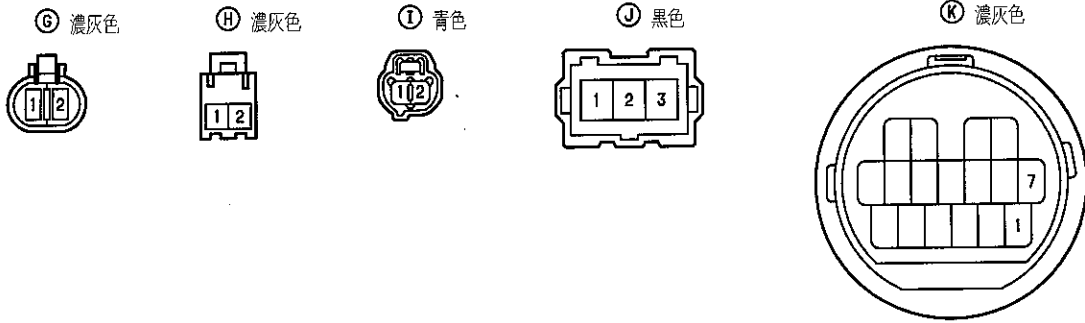
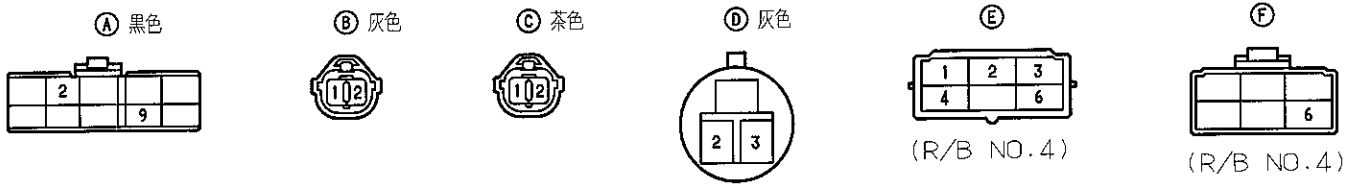

# EFI (1G-FE)

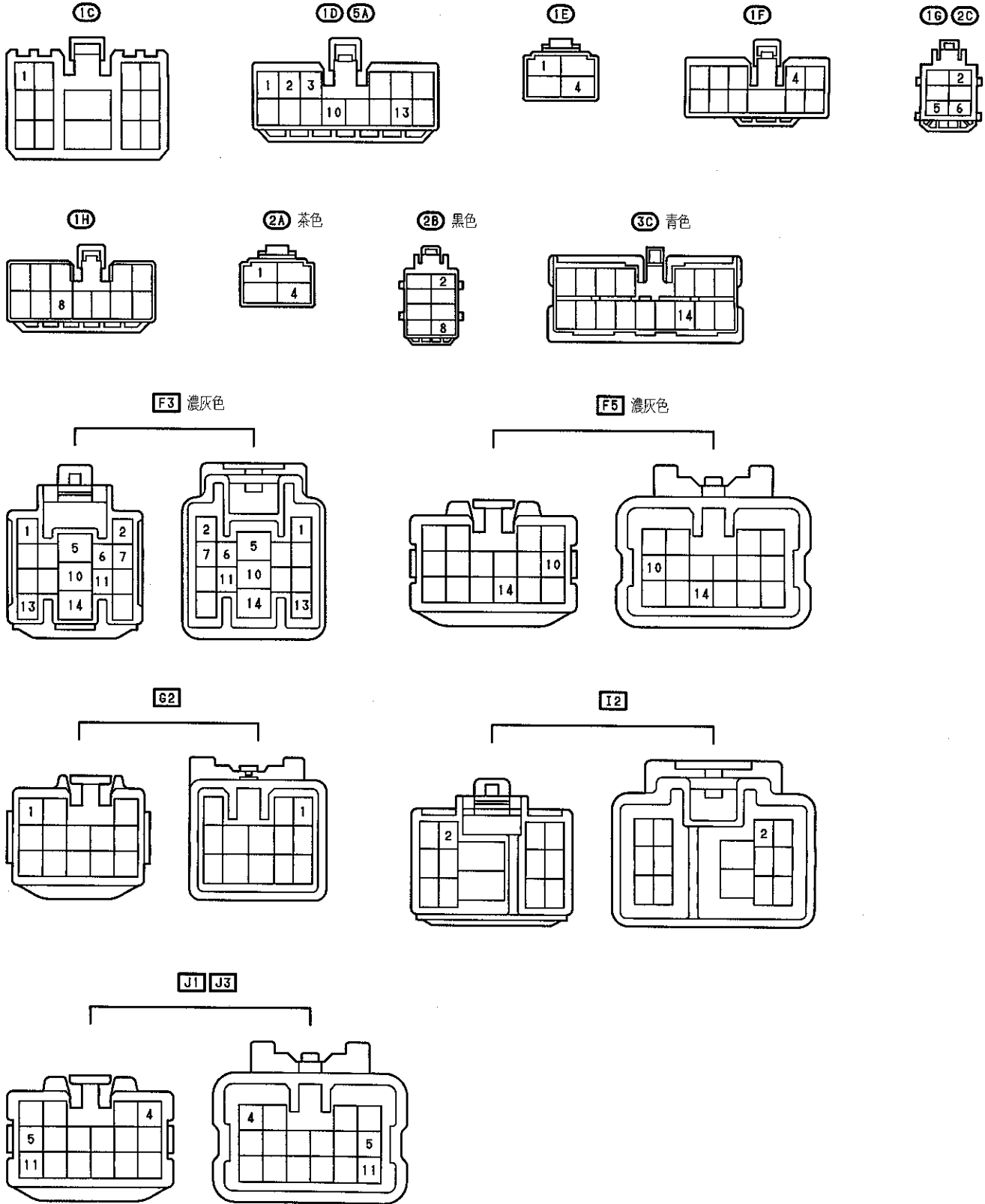

Q1

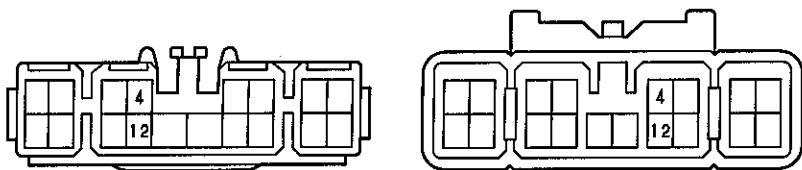

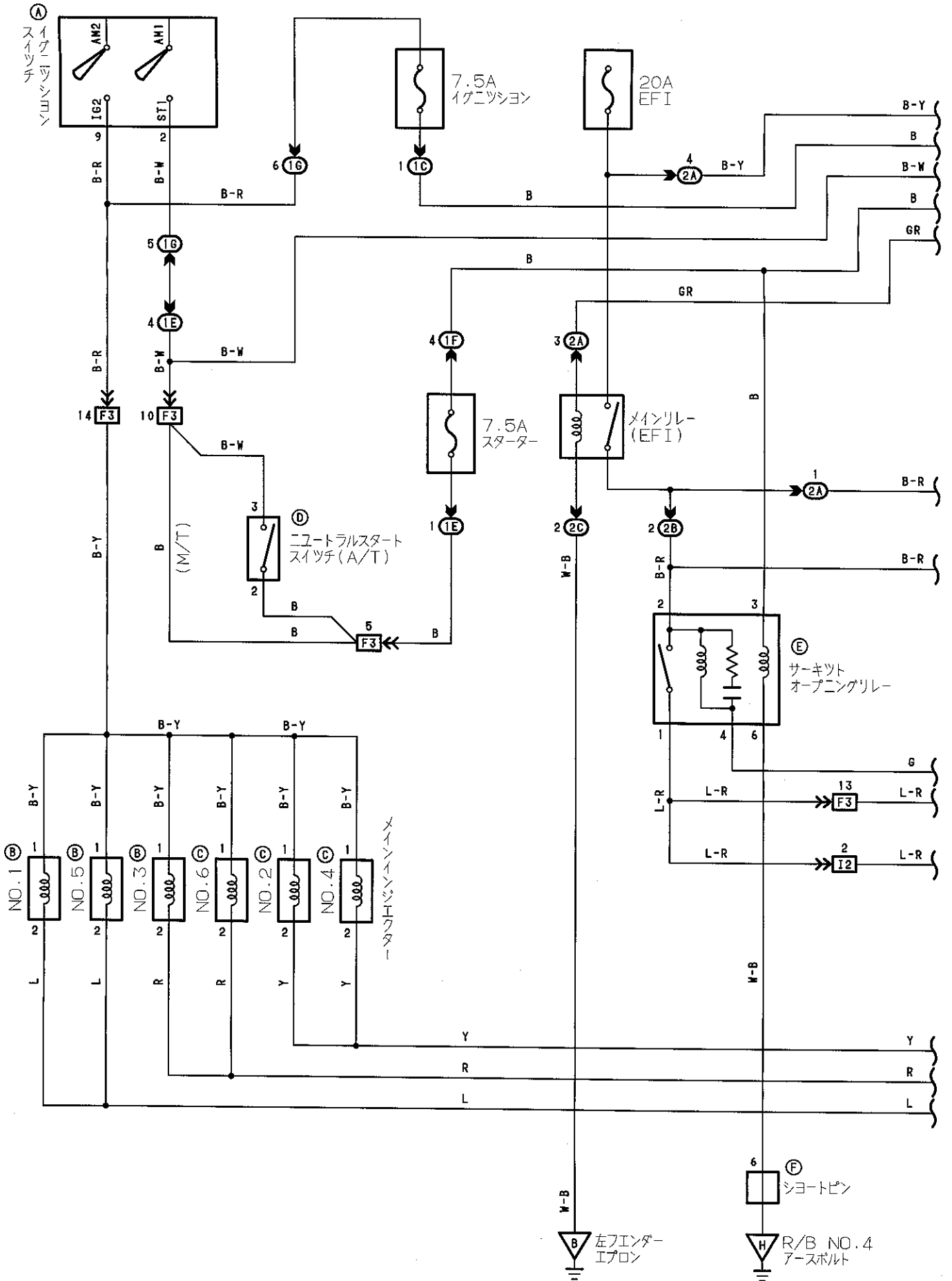

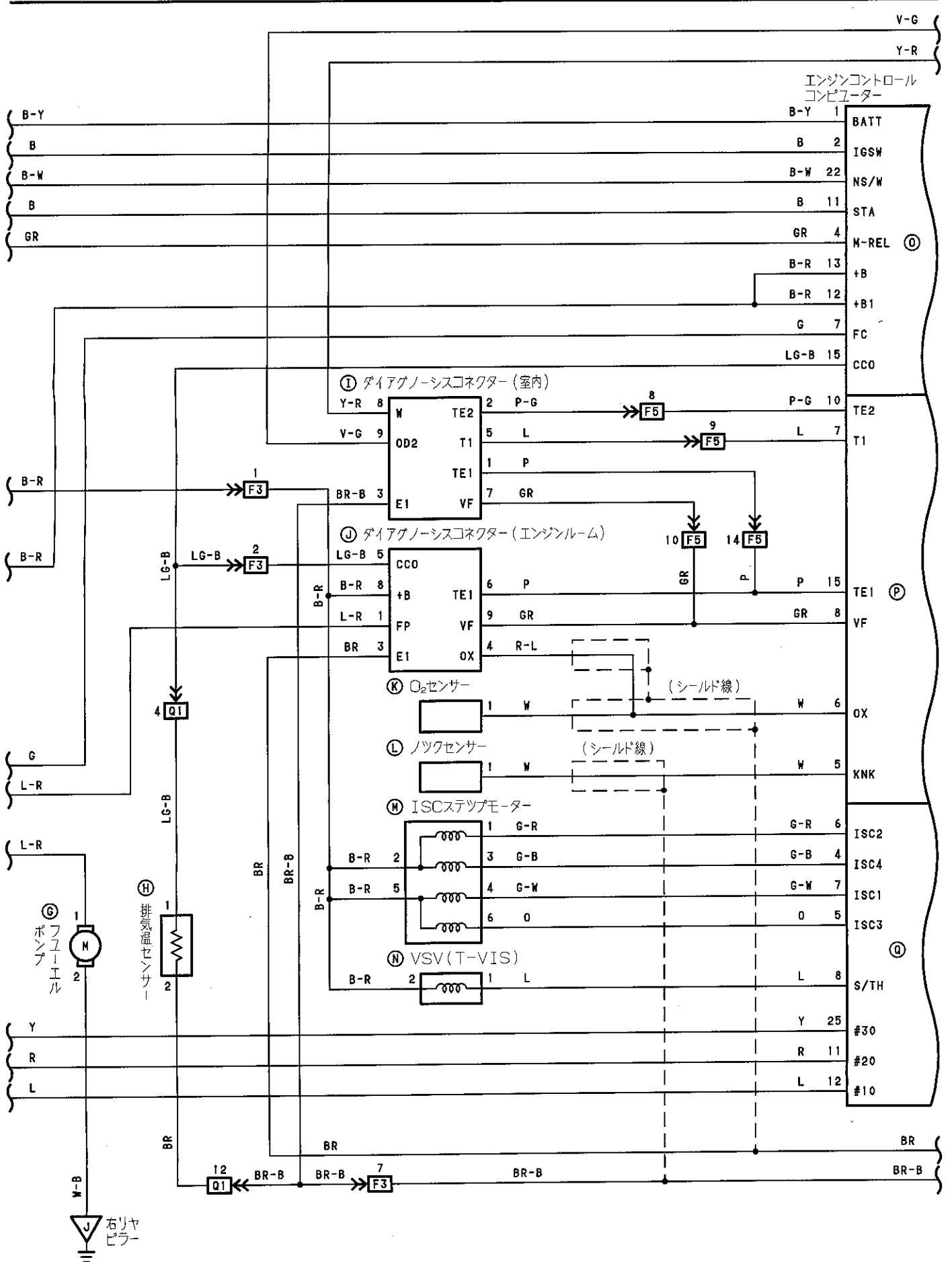

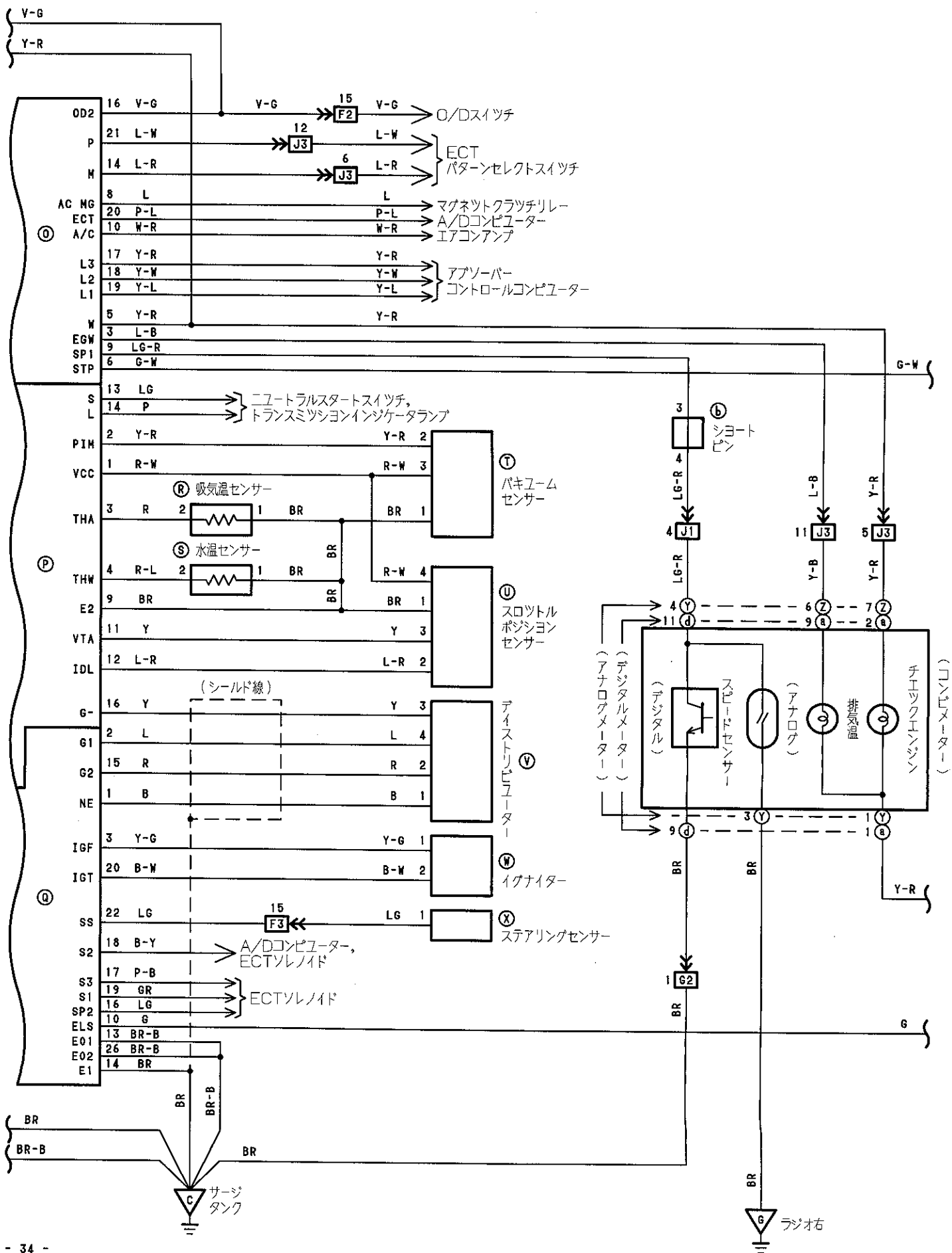

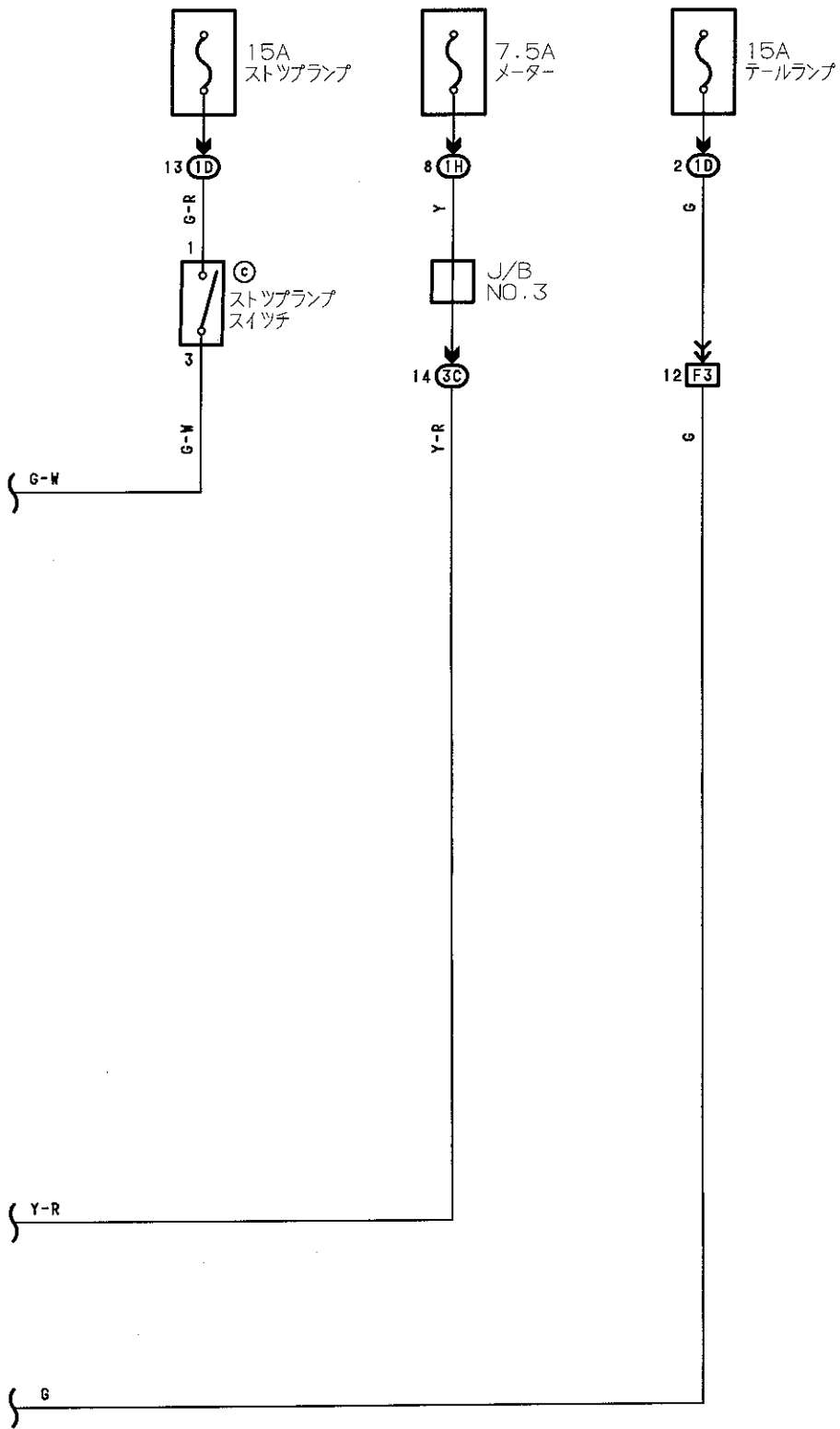

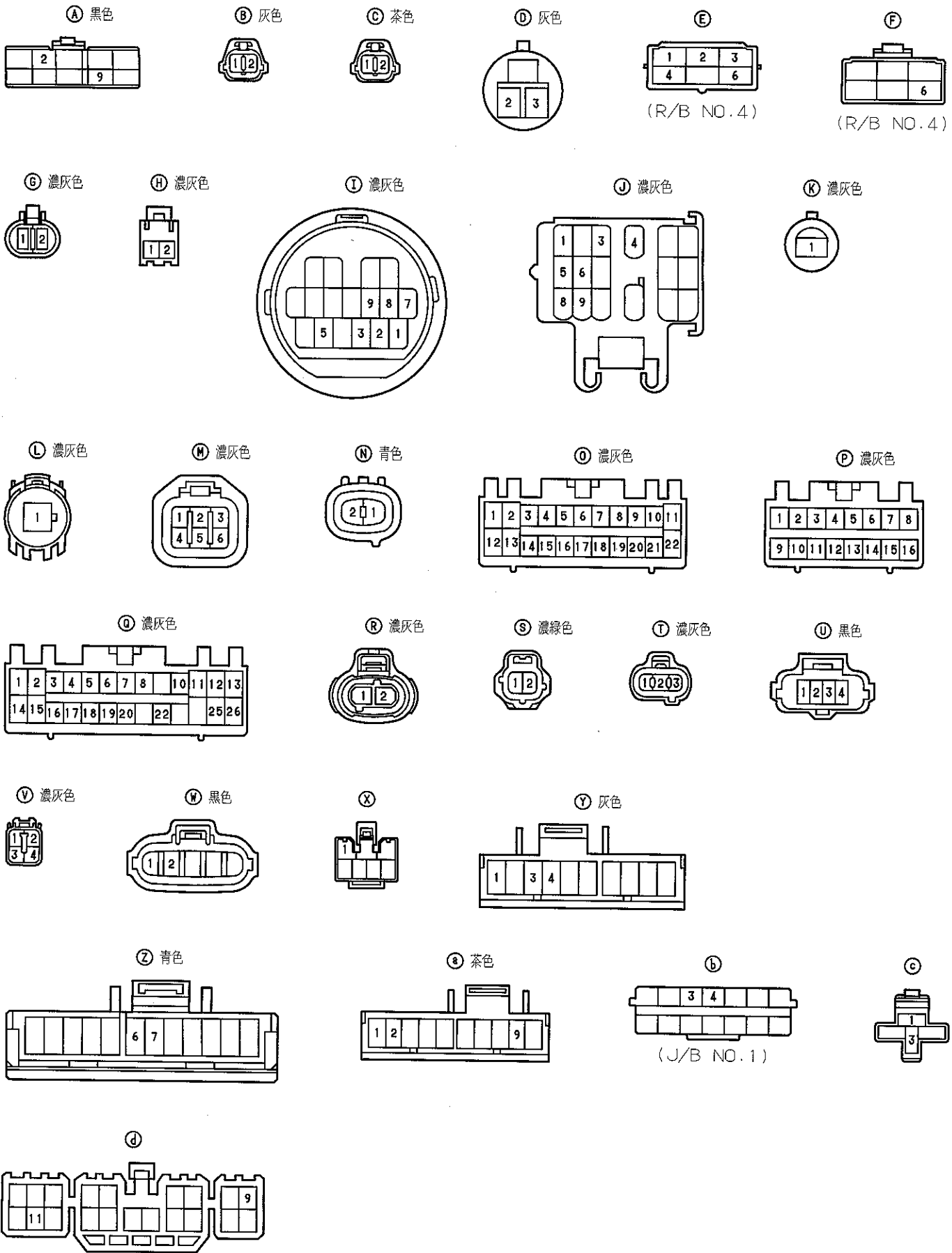

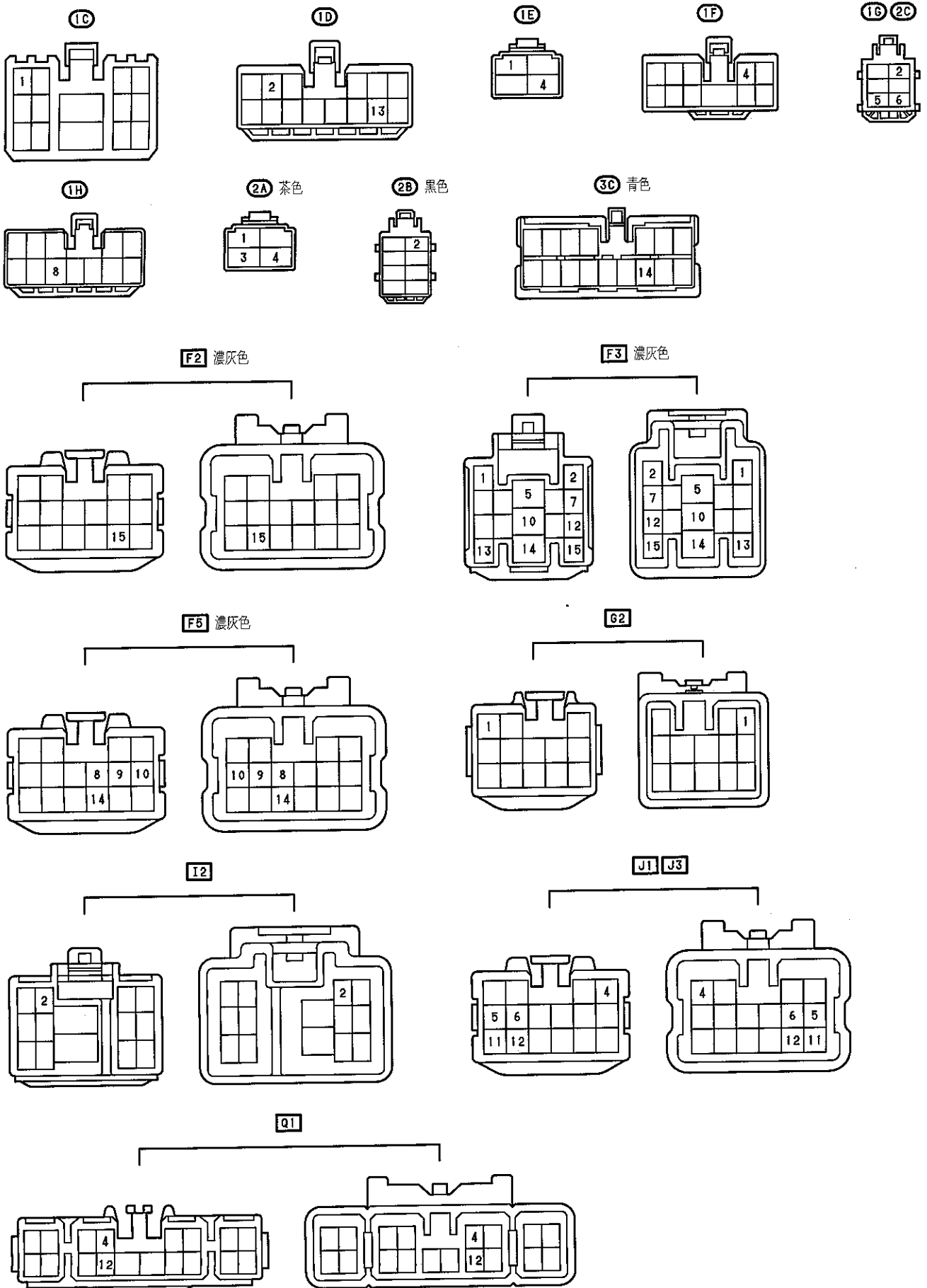

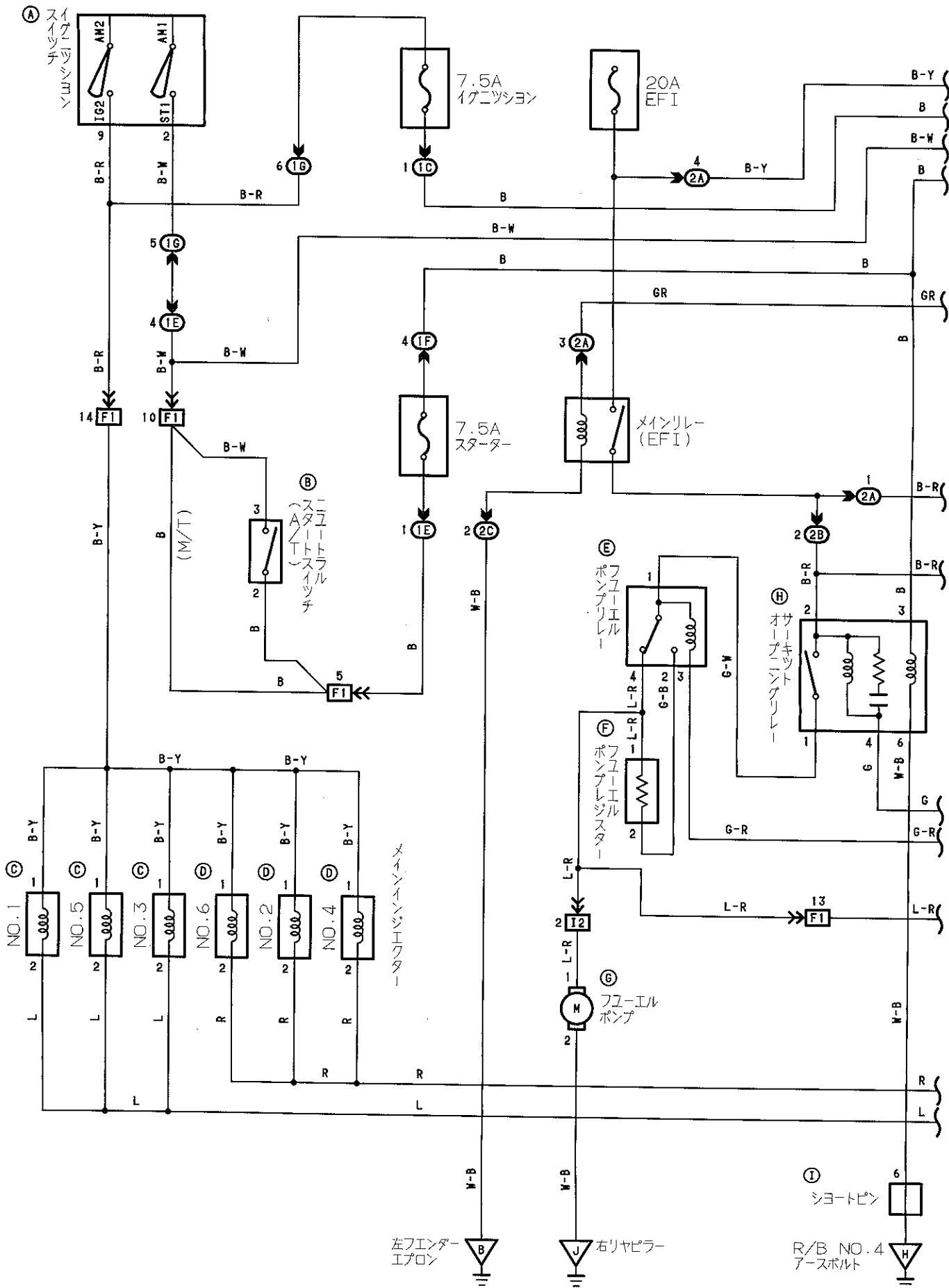

エンジンコントロール  
コンピューター

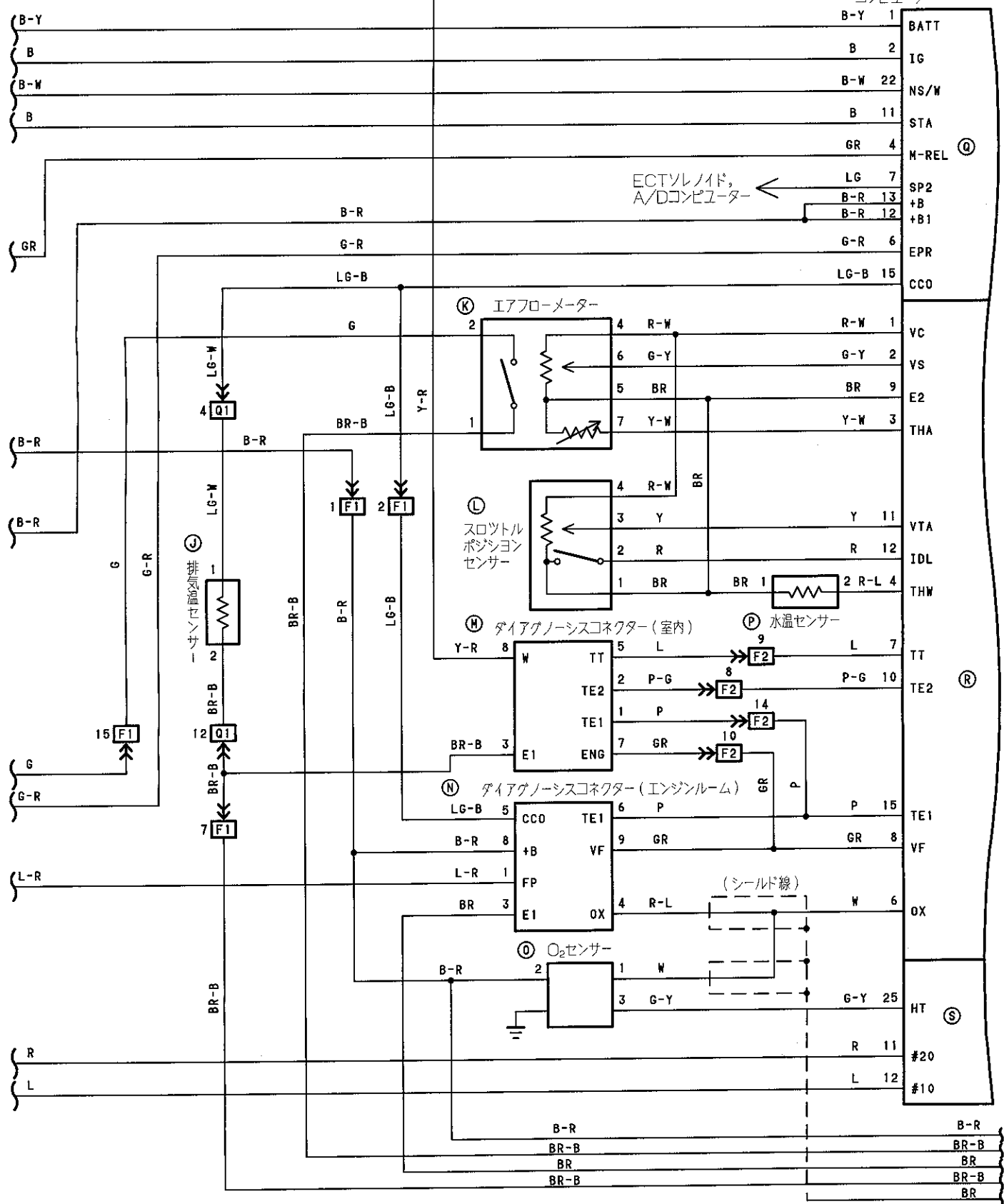



# EFI (1G-GTE)

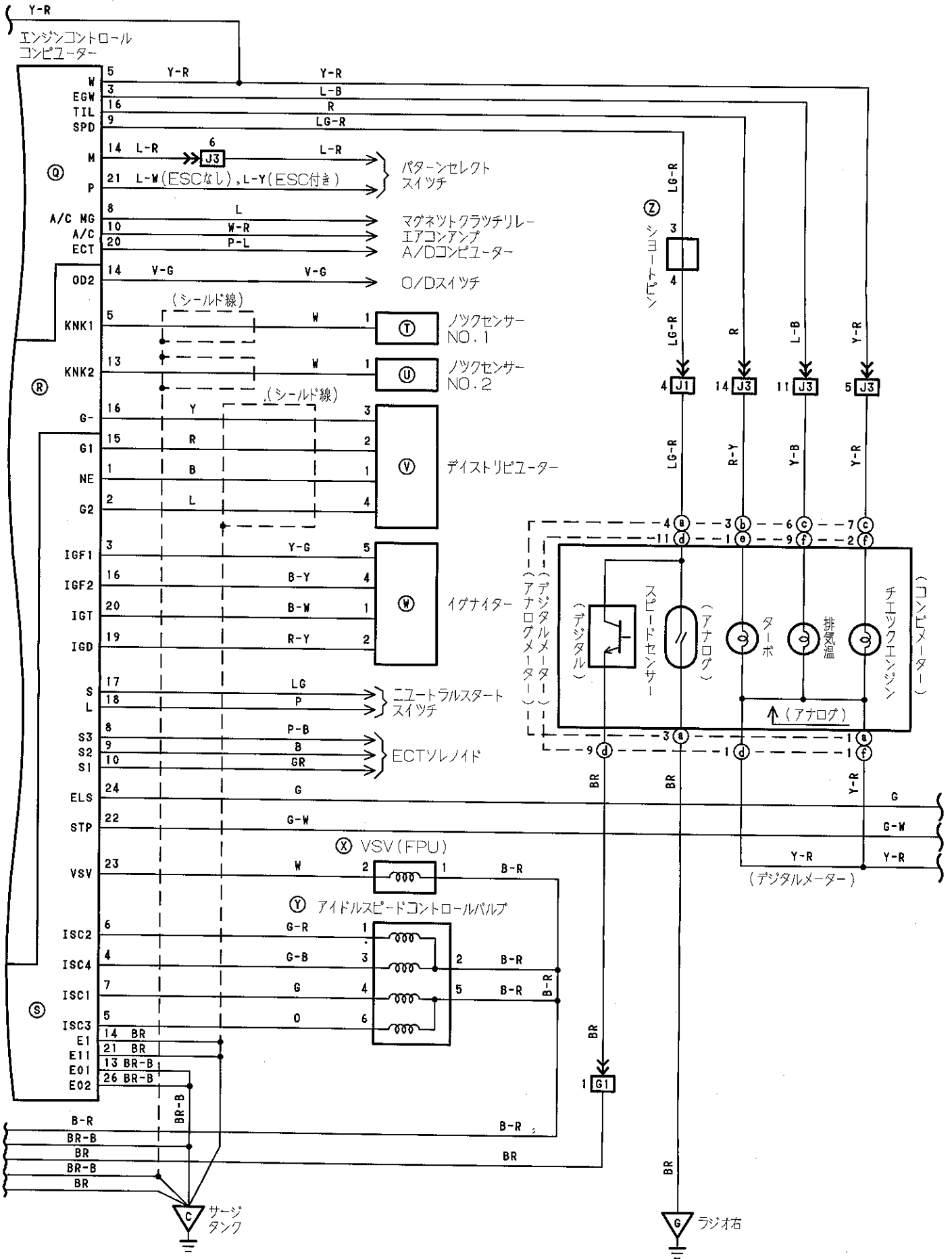

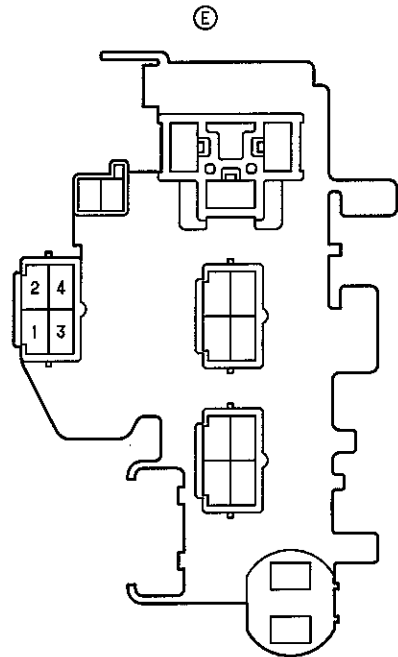
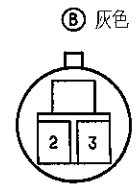
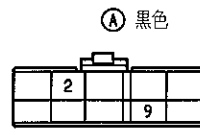
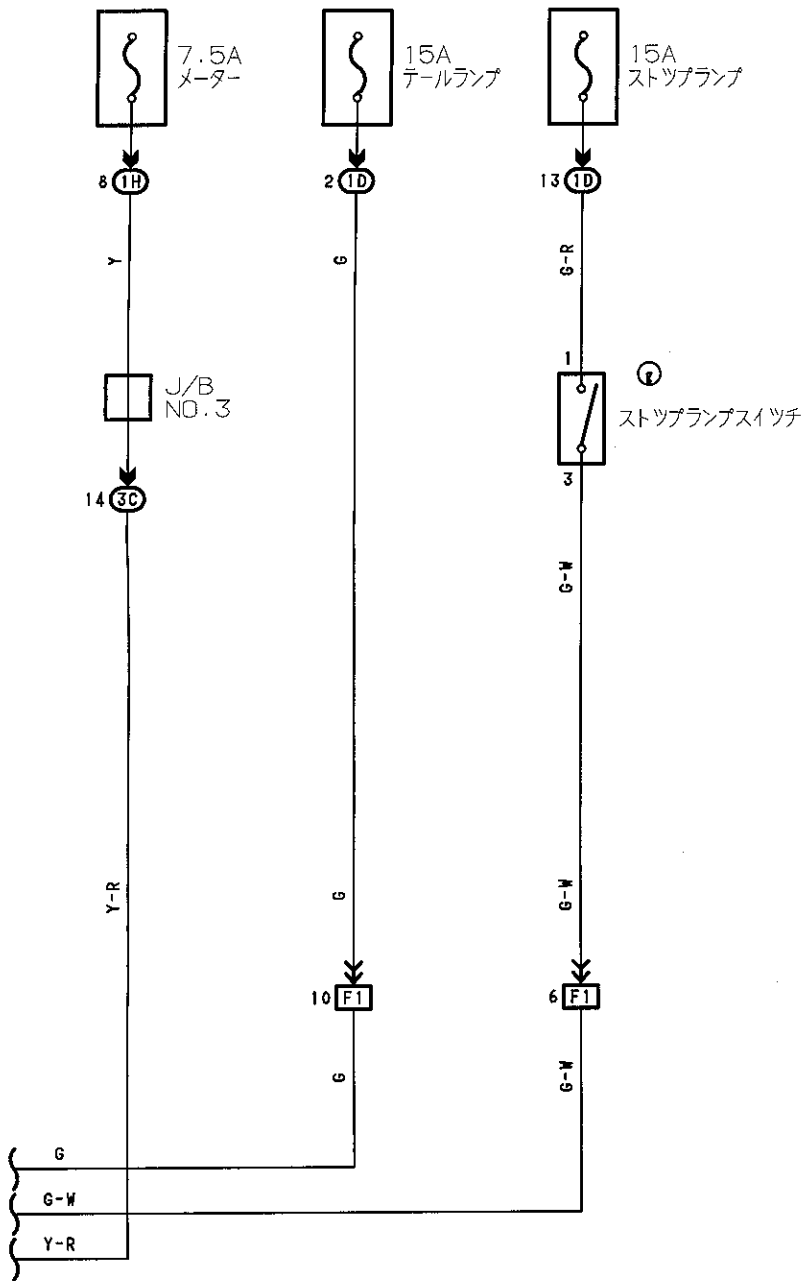

(J/B NO.1)

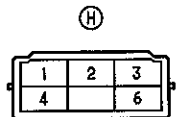
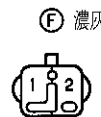

(R/B NO.4)

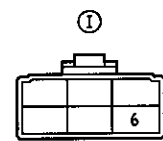

(R/B NO.4)

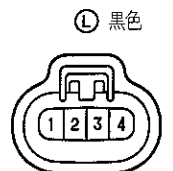

Ⓜ 濃灰色

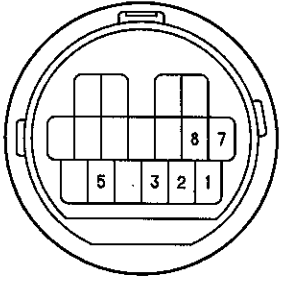

Ⓝ 濃灰色

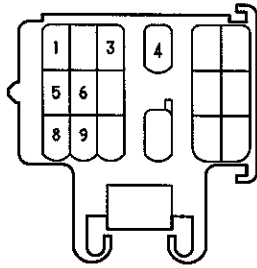

ⓐ 灰色



Ⓟ 濃綠色



ⓓ 濃灰色

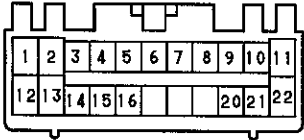

Ⓡ 濃灰色

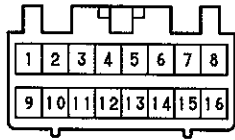

Ⓢ 濃灰色

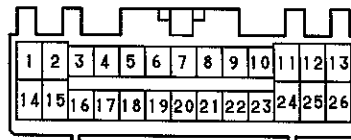

Ⓣ Ⓤ 濃灰色



Ⓥ 濃灰色



Ⓦ 濃灰色

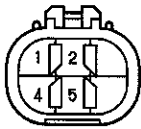

Ⓧ 青色



Ⓨ 濃灰色

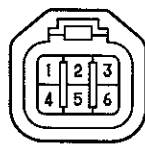

Ⓩ

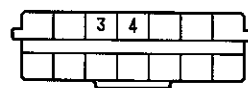

(J/B NO.1)

ⓐ 灰色

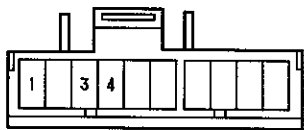

ⓑ ⓕ 茶色

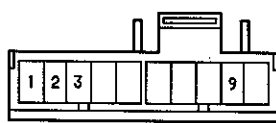

ⓒ 青色

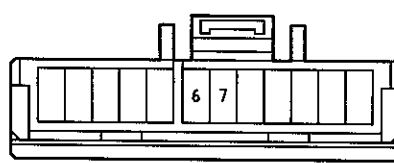

ⓓ

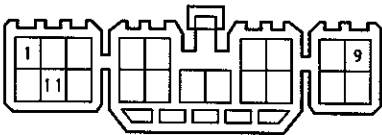

ⓔ

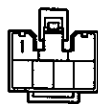

ⓕ

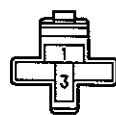

ⓓC

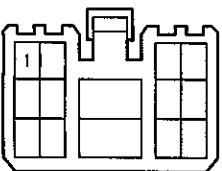

ⓓD

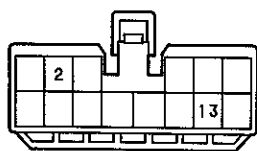

ⓓE

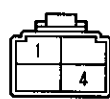

ⓓF

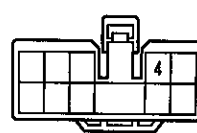

ⓓG ⓓC

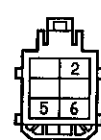

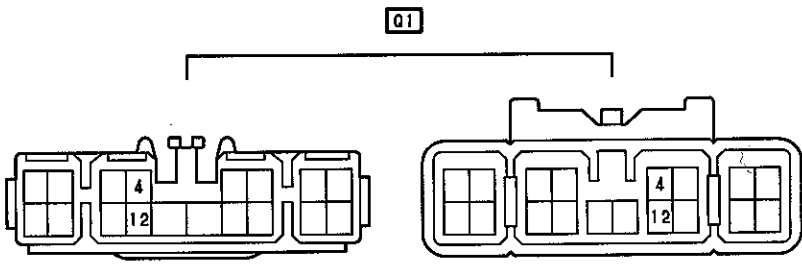
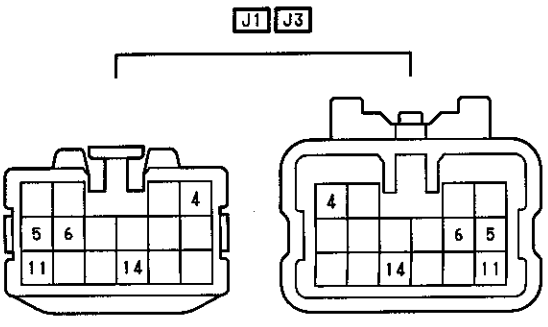
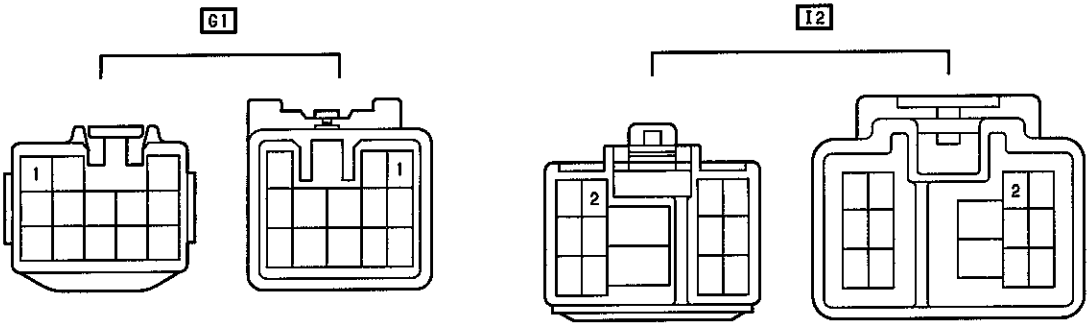
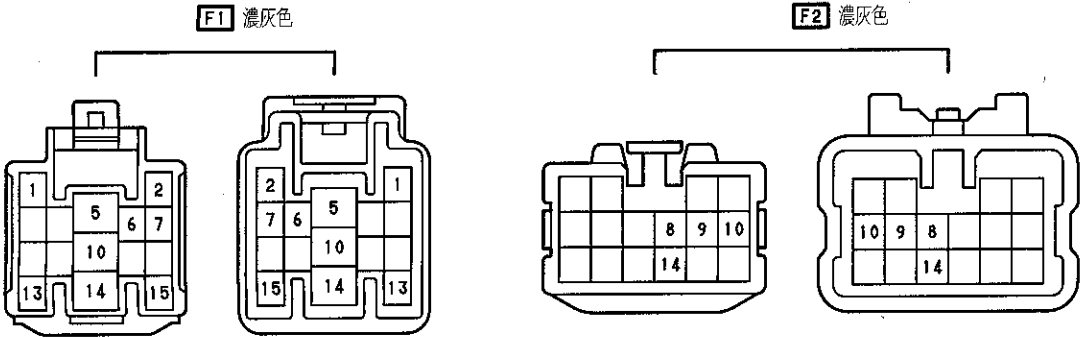
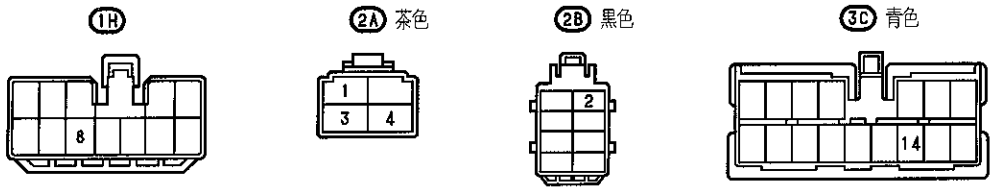



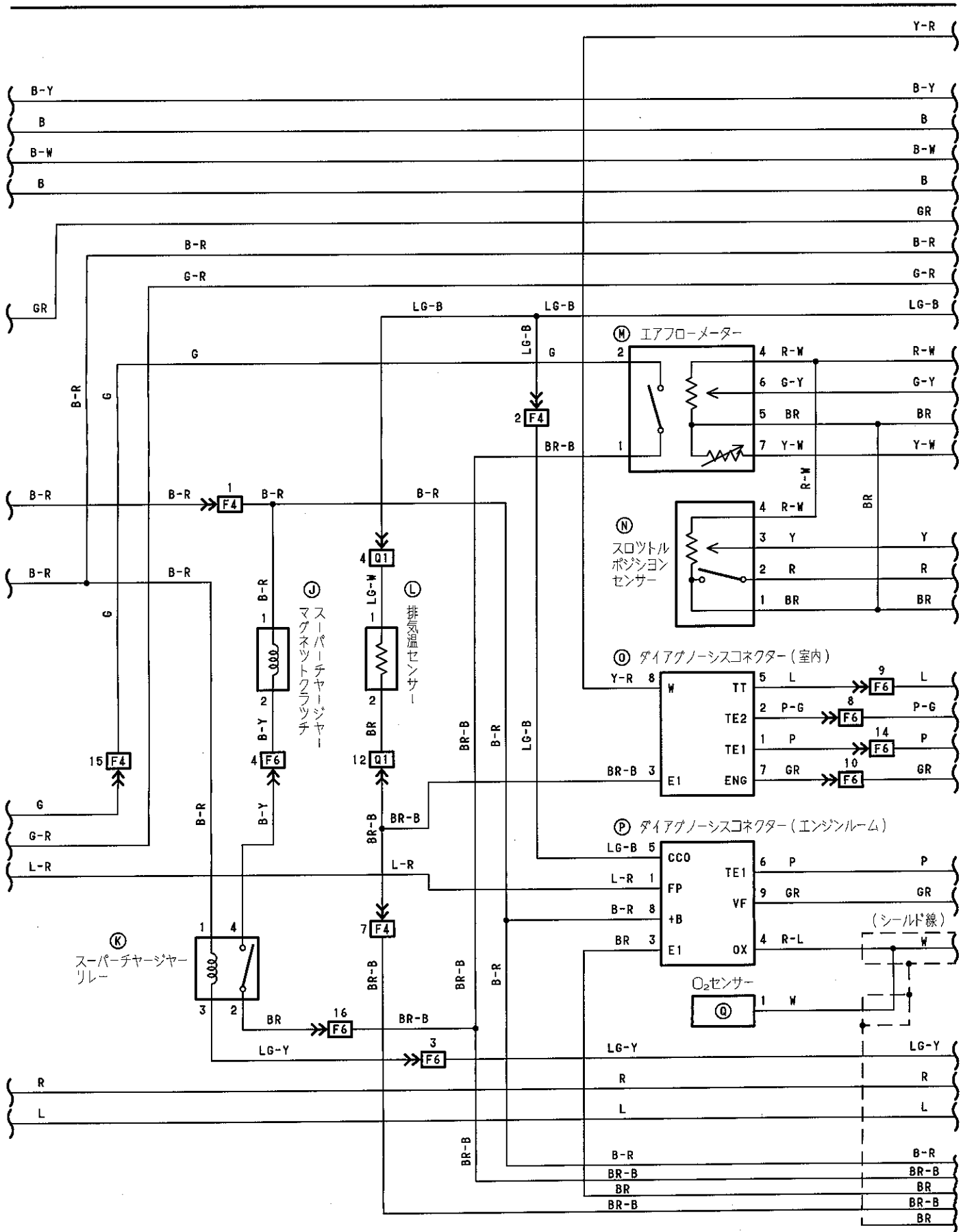



# EFI (1G-GZEトラクションコントロールなし)

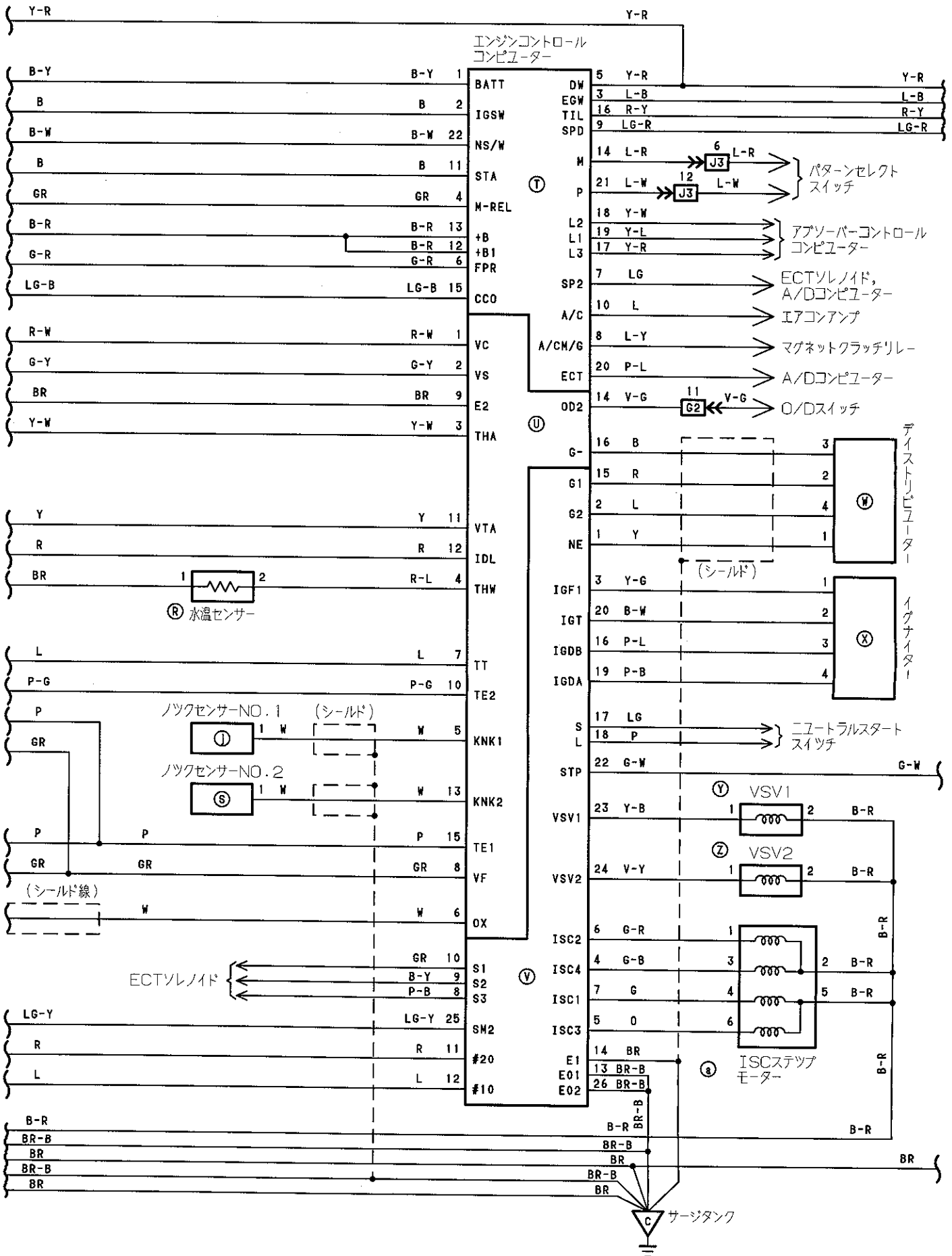

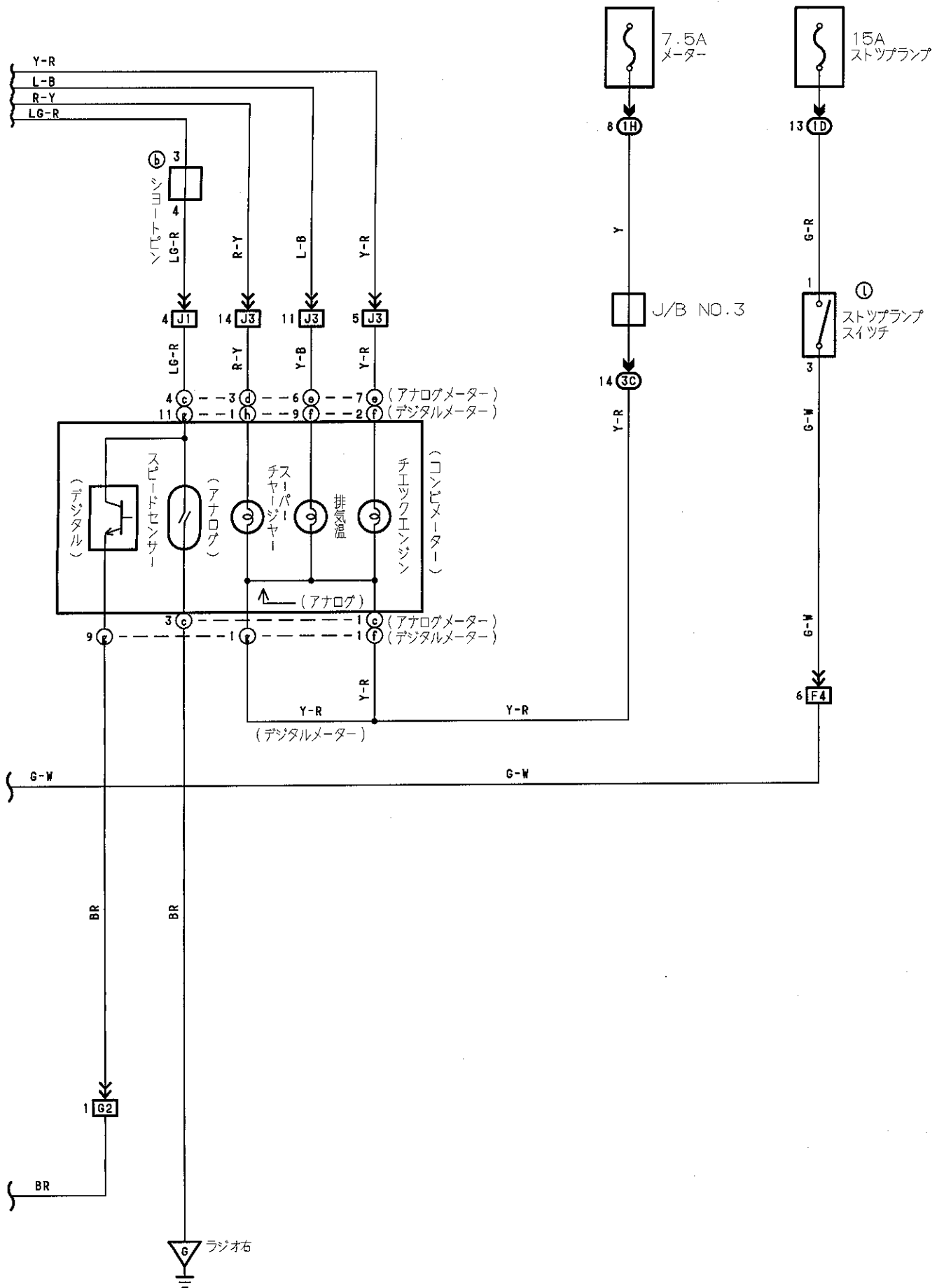

# EFI (1G-GZEトラクションコントロールなし)

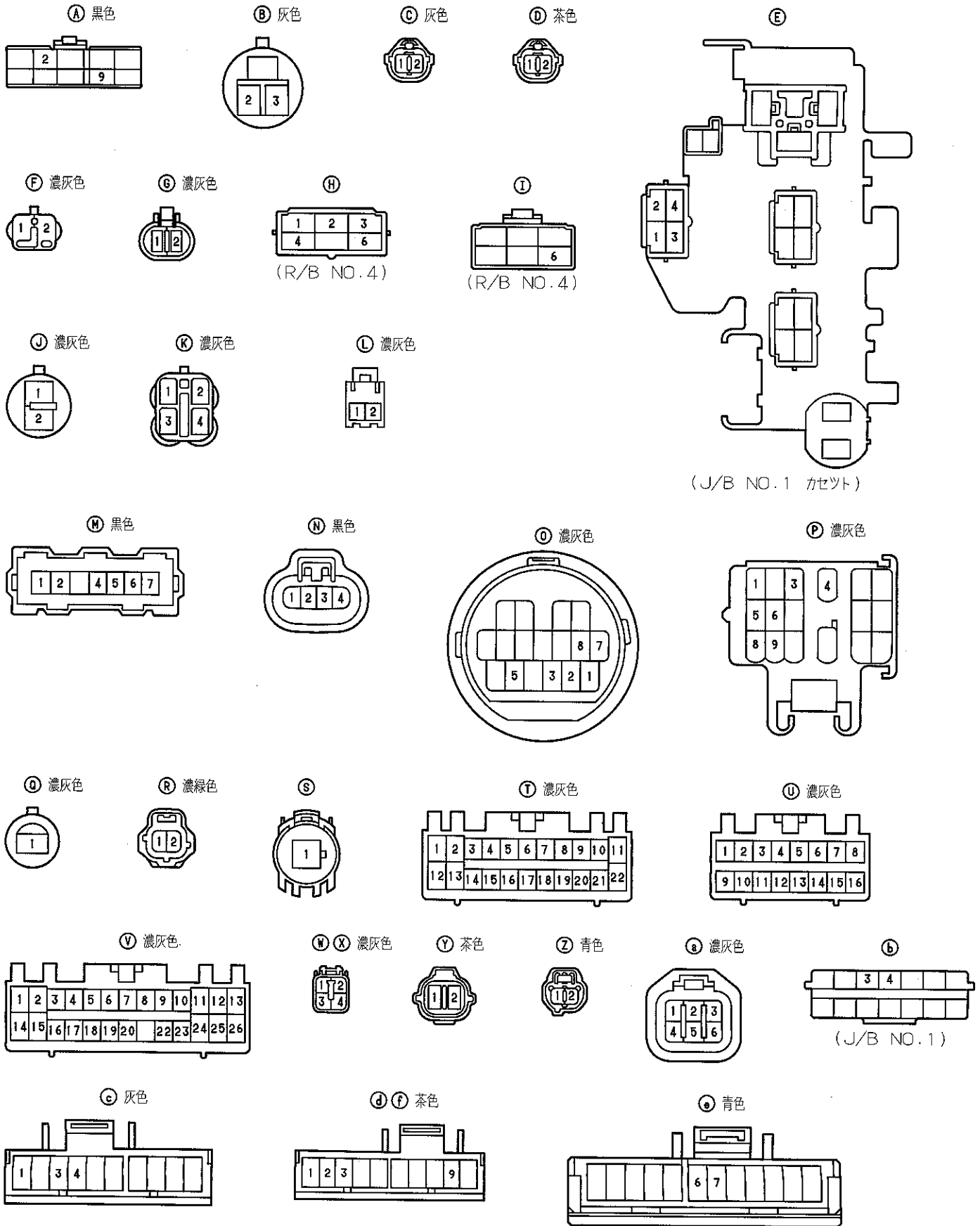

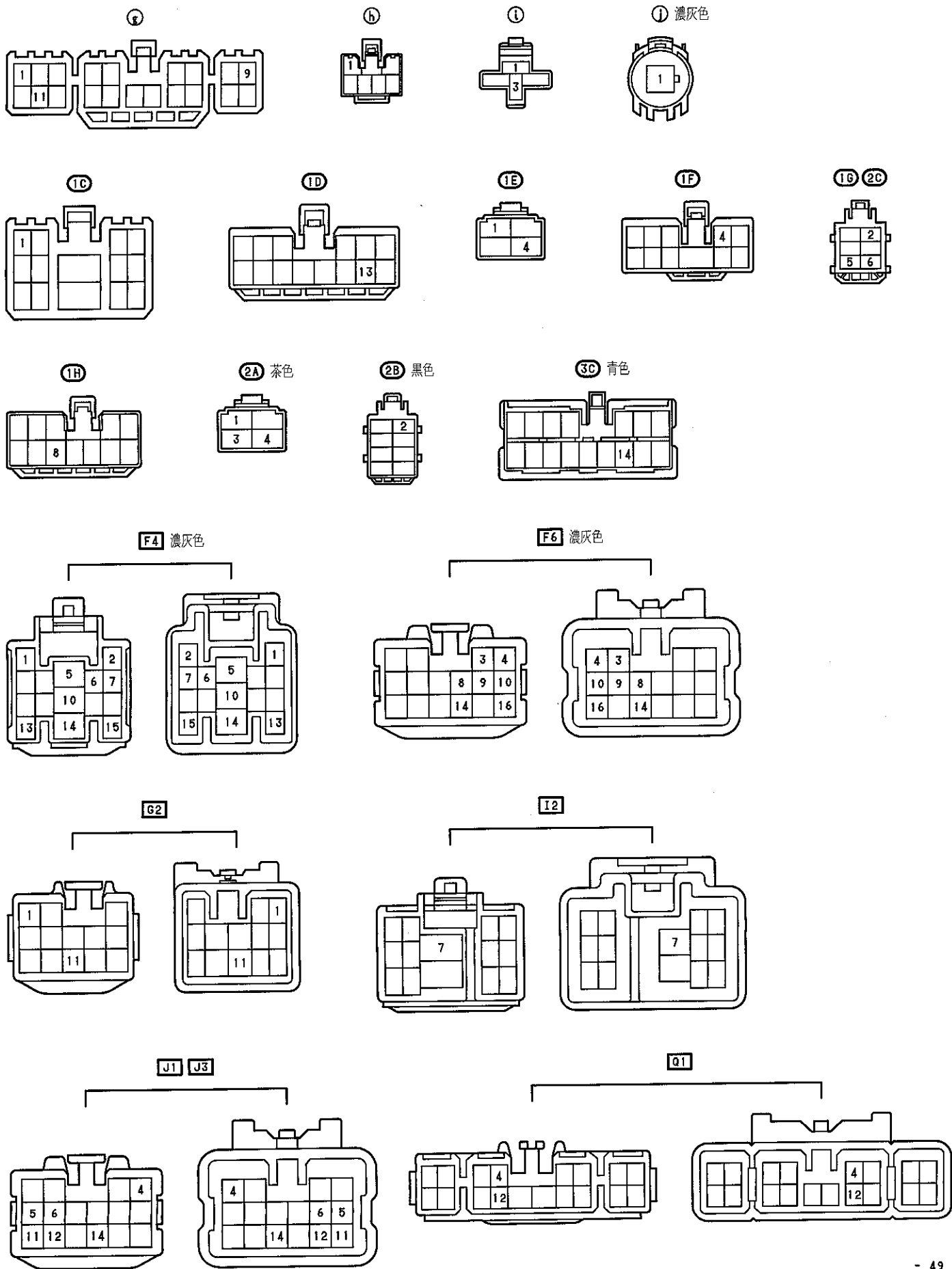



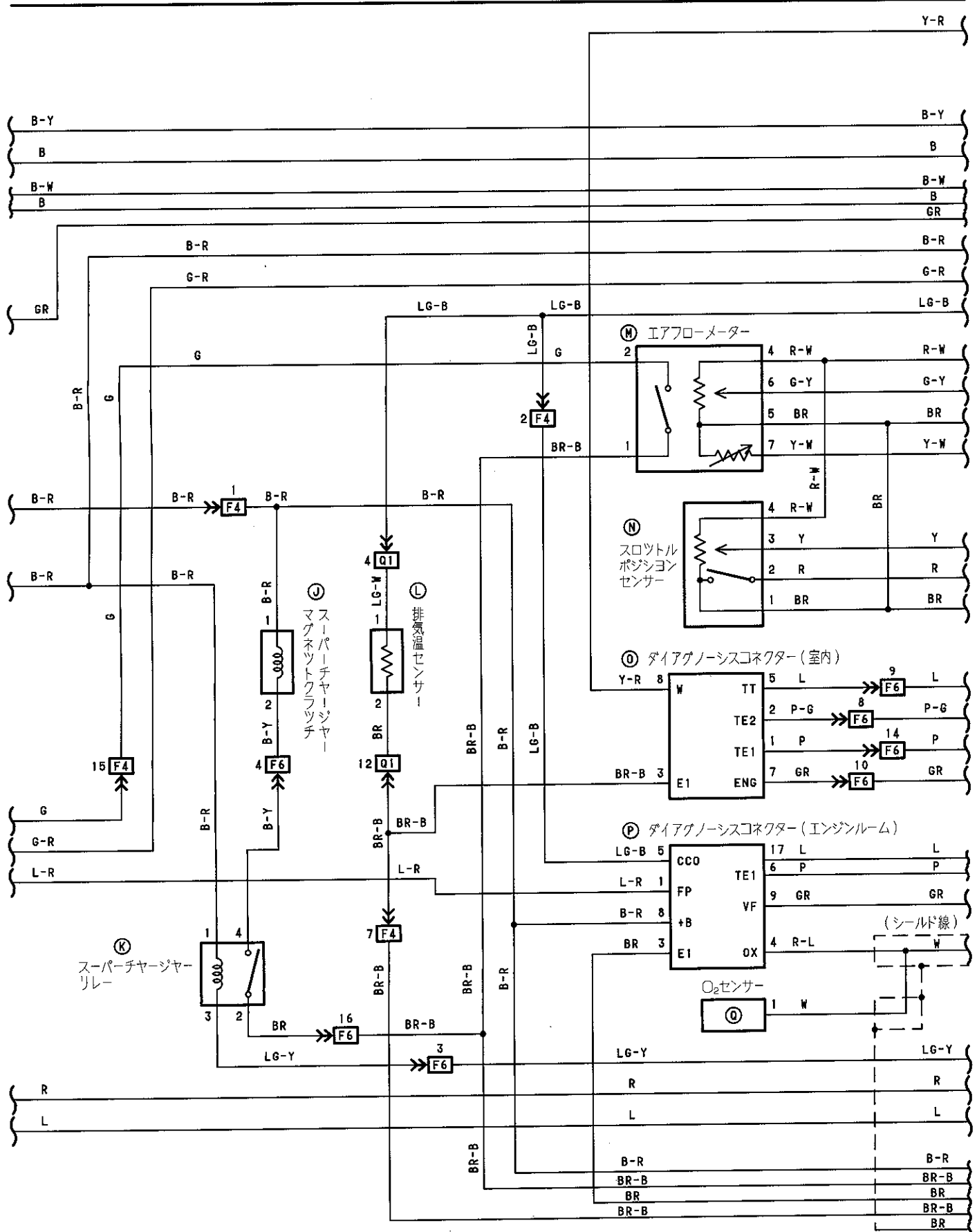



# EFI (1G-GZEトラクションコントロール付き)

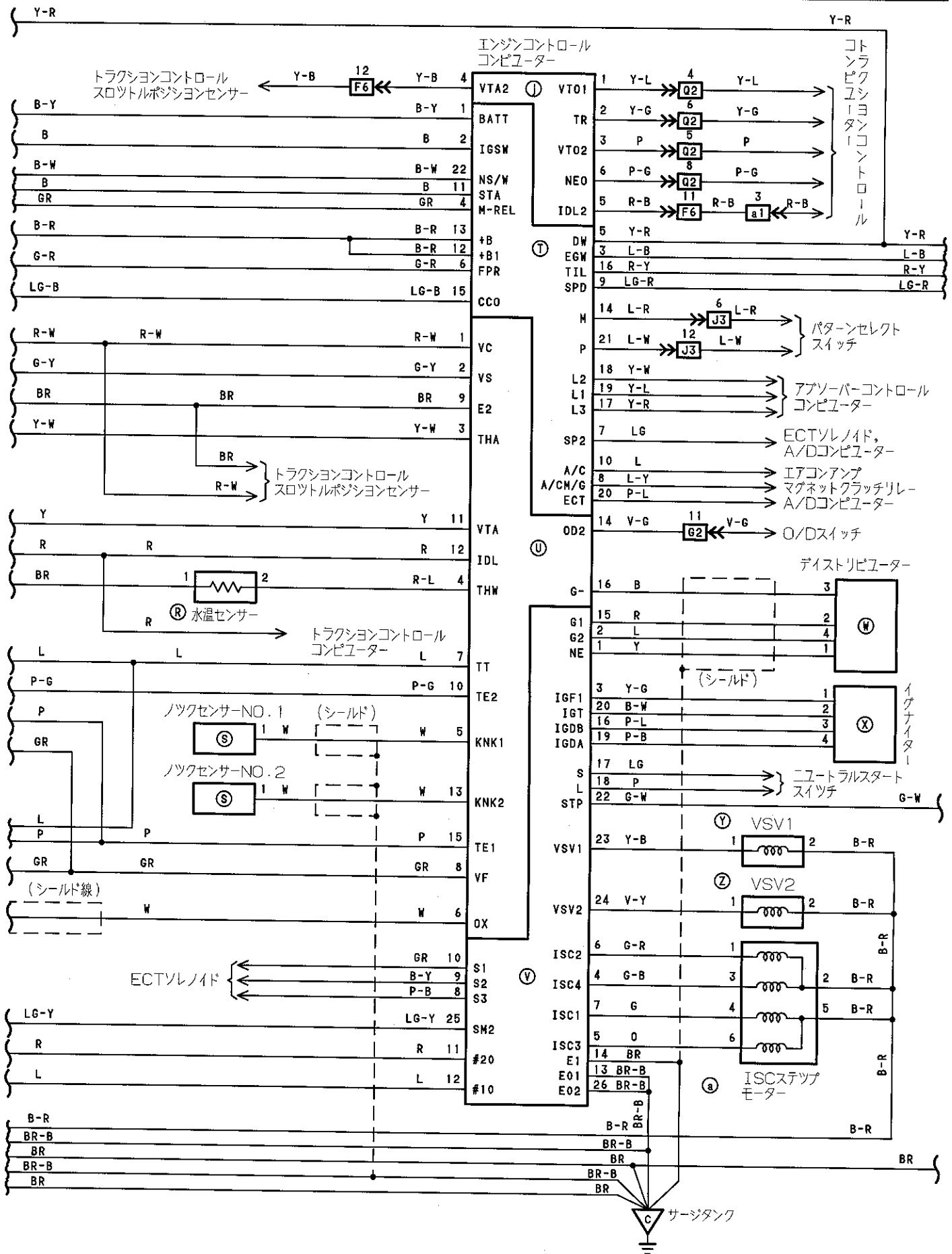

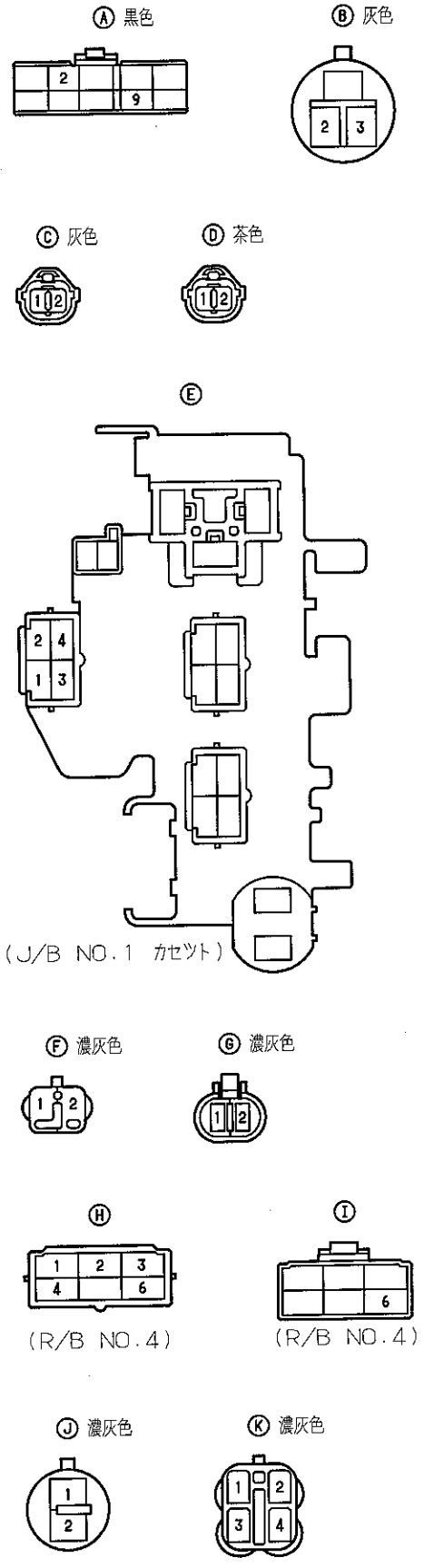
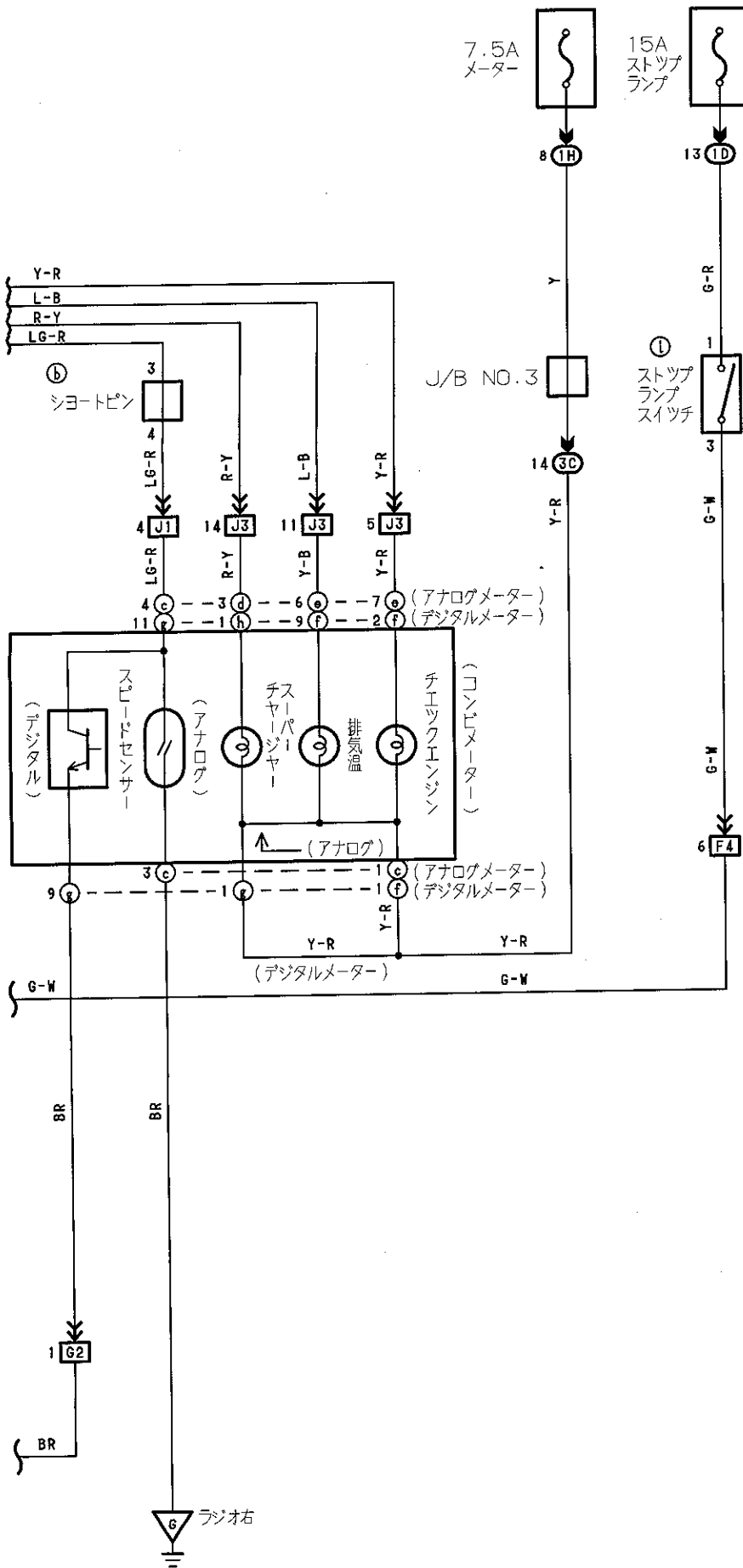

# EFI (1G-GZEトランクシヨンコントロール付き)

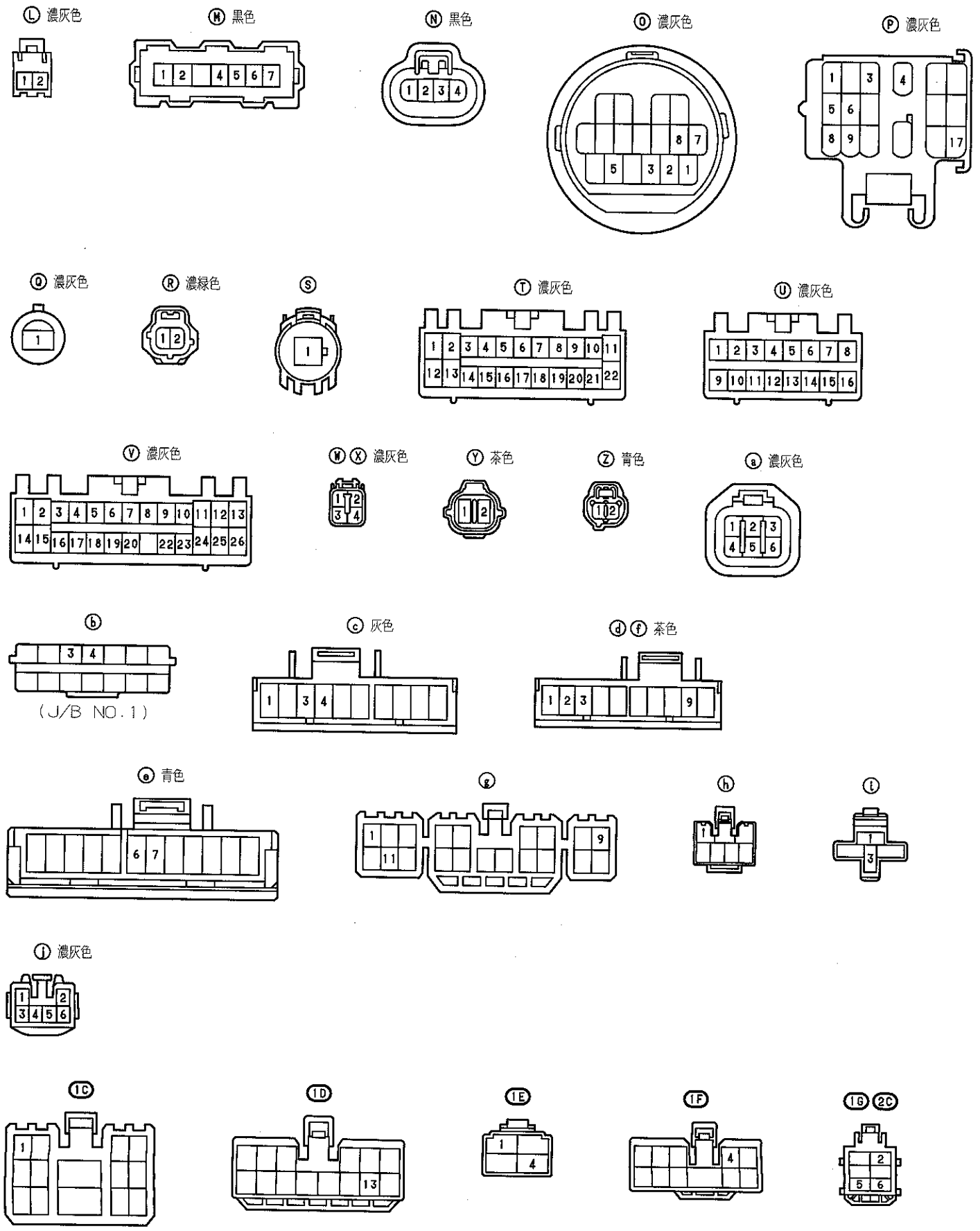

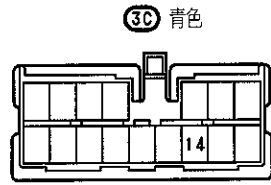
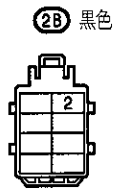
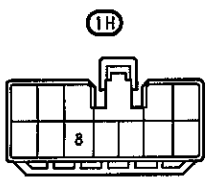

**F4** 濃灰色

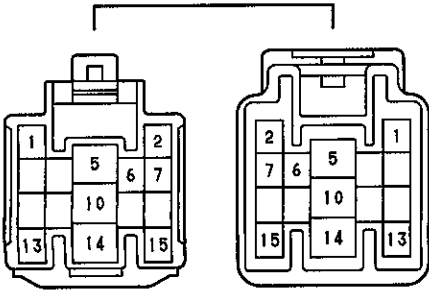

**F6** 濃灰色

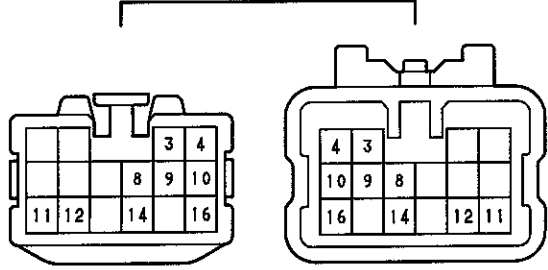

**G2**

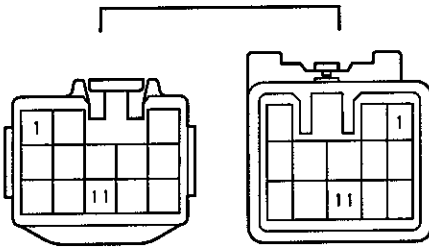

**I2**

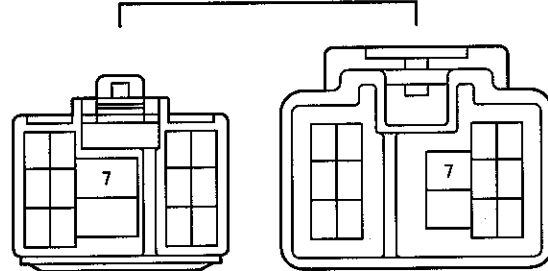

**J1 J3**

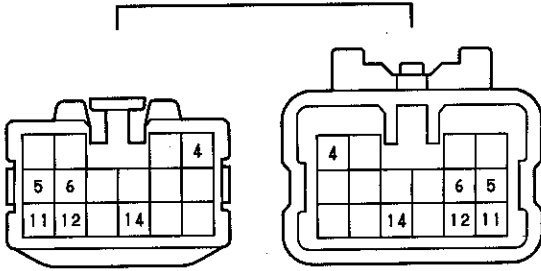

**Q1**

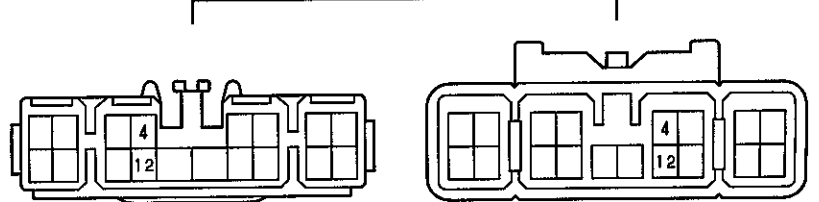

**Q2**

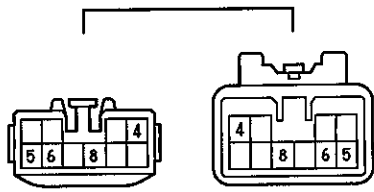

**a1** だいだい色

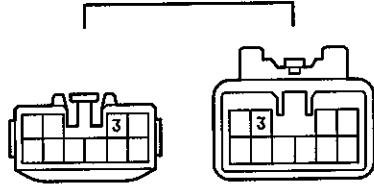

# EFI (7M-GE)

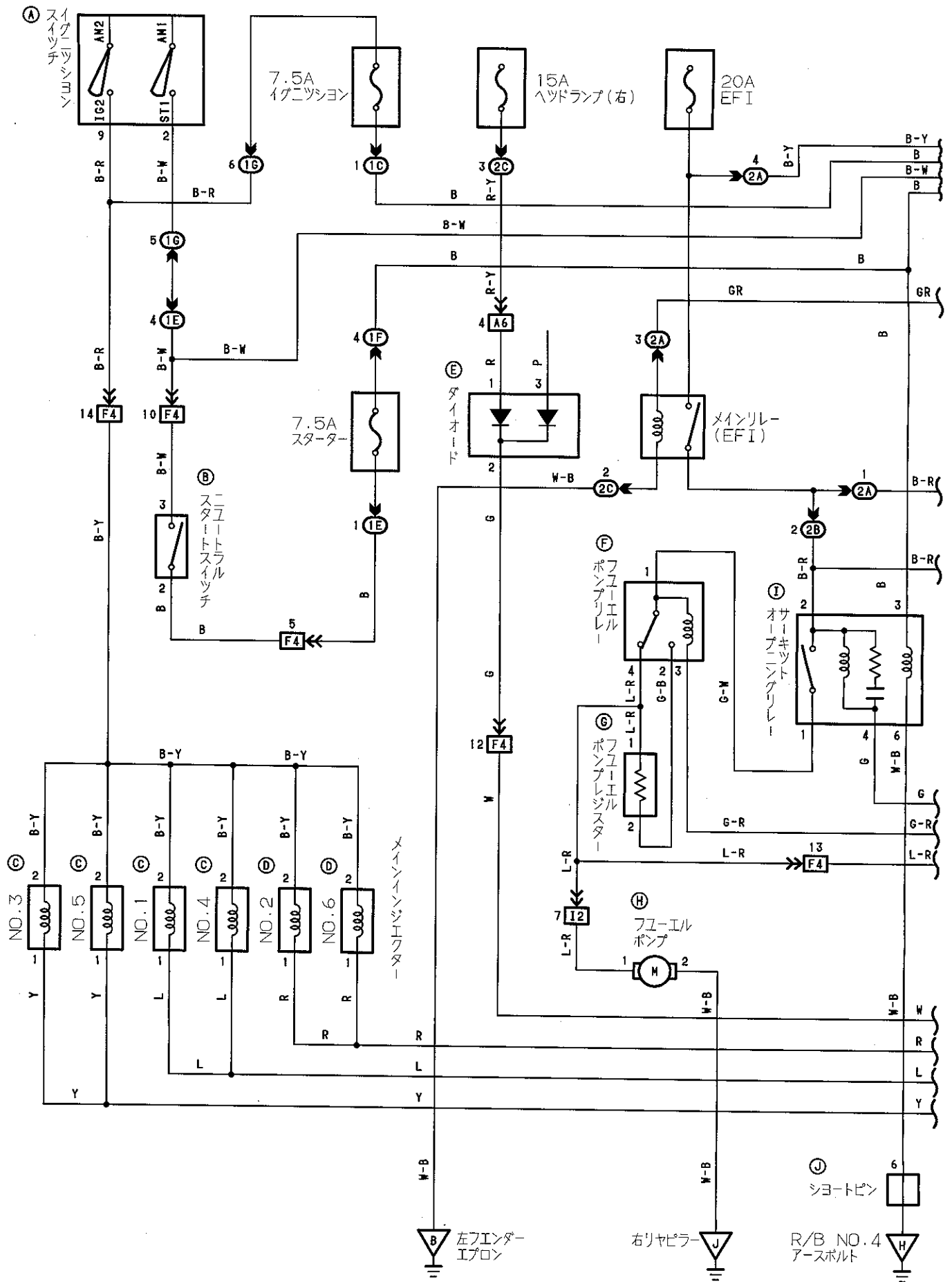

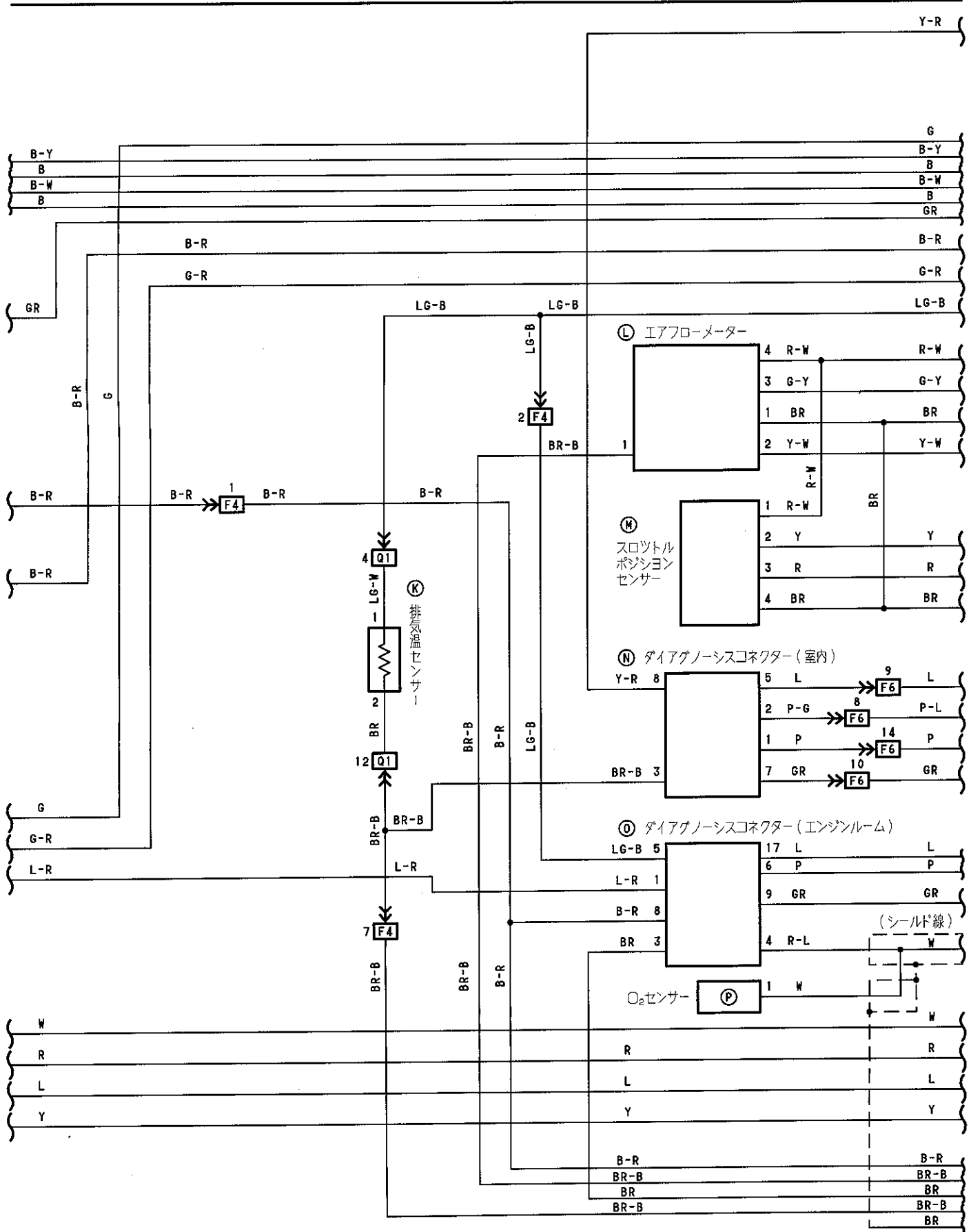



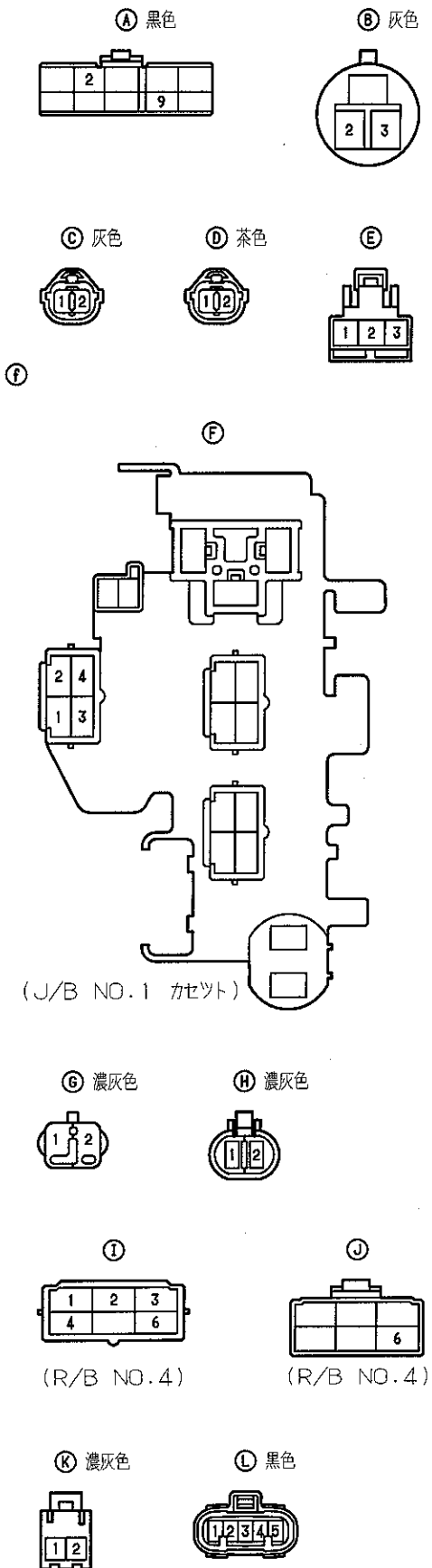
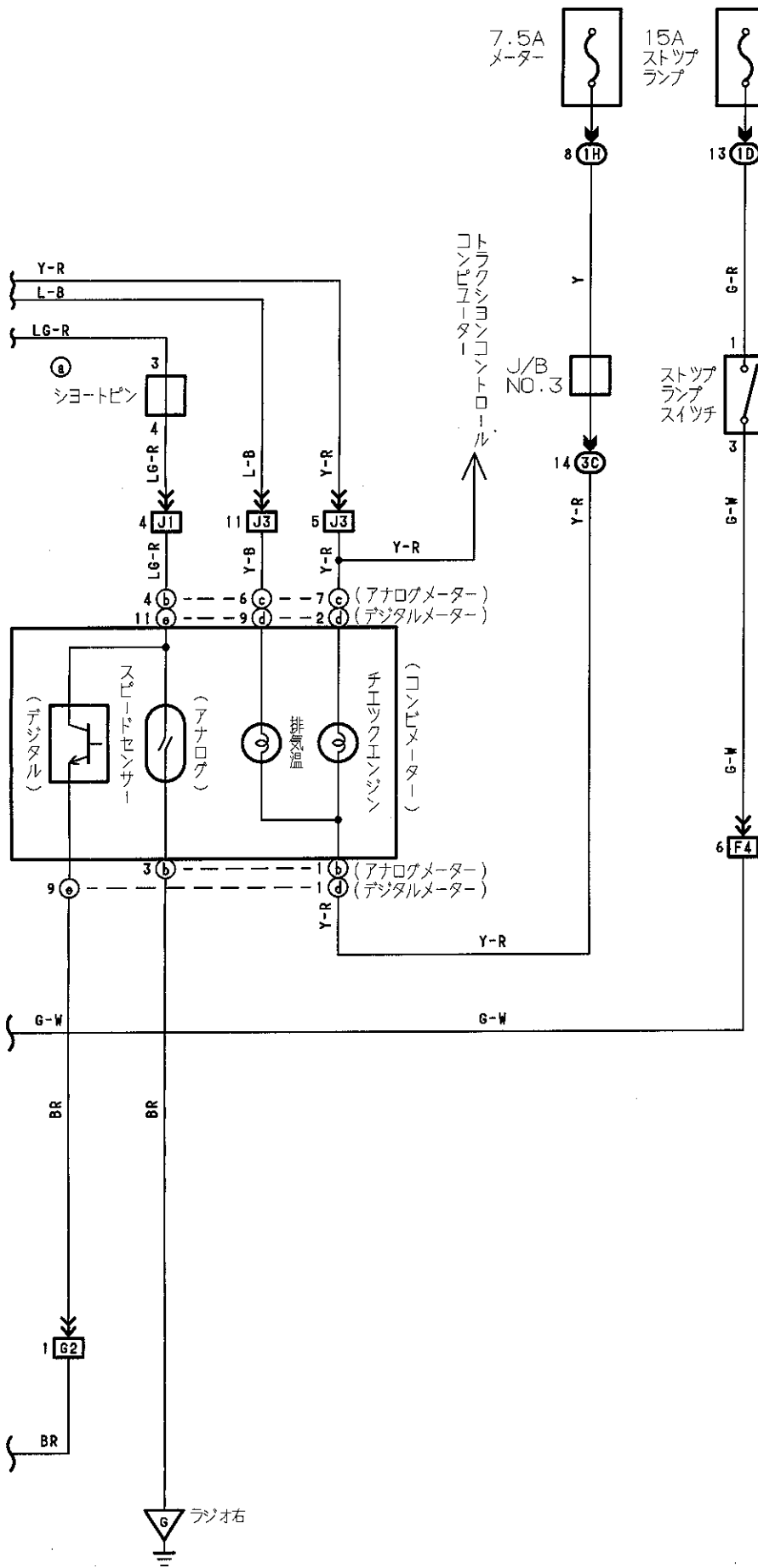

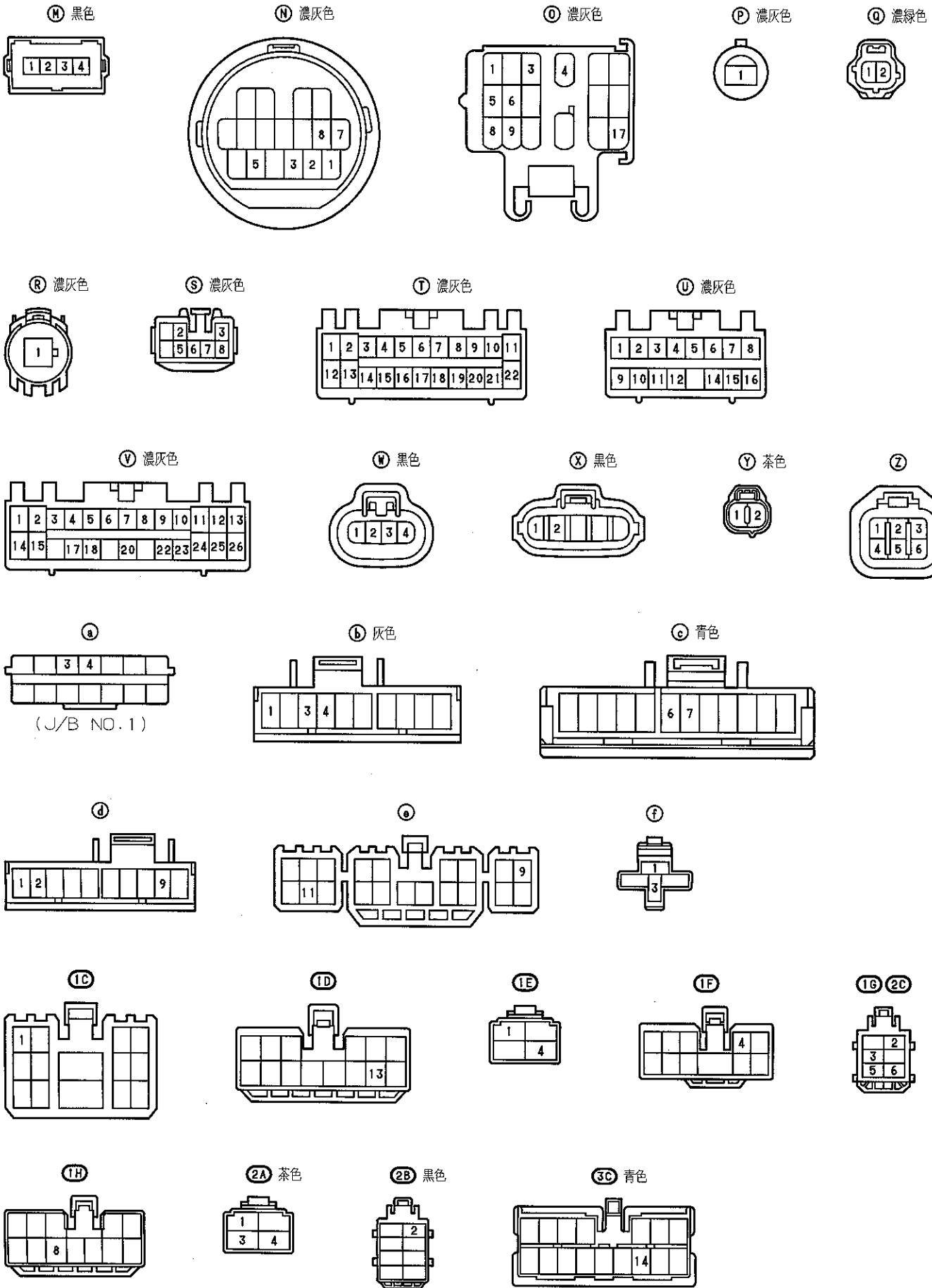

A6 灰色

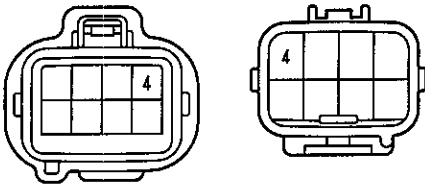

F4 濃灰色

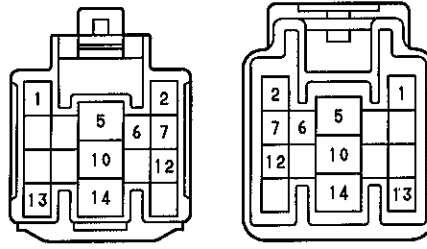

F6 濃灰色

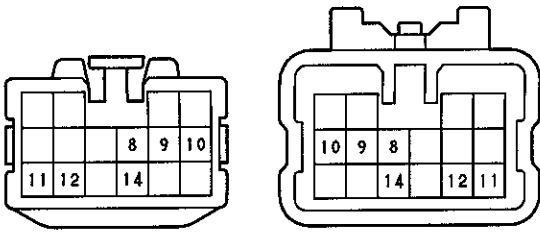

G2

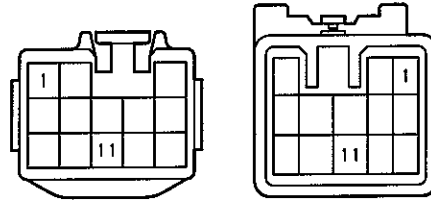

I2

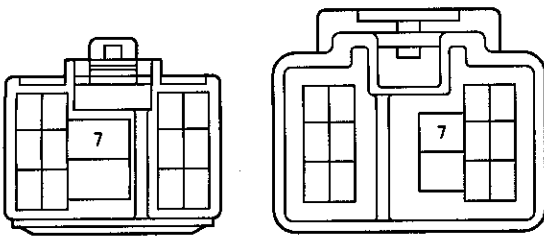

J1 J3

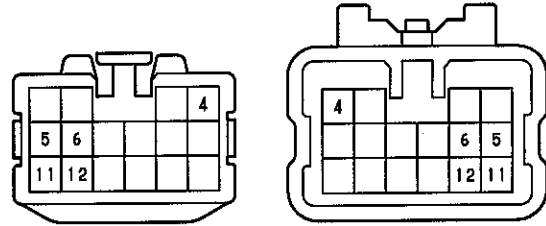

Q1

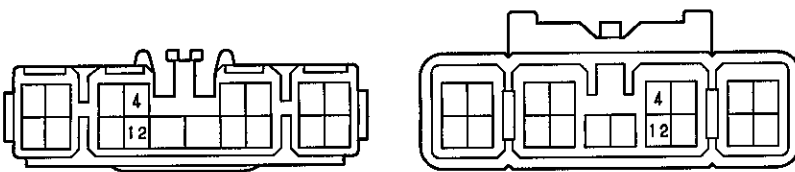

Q2

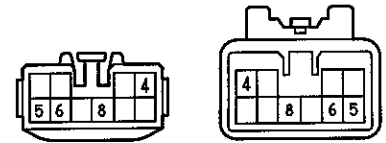

a1 だいたい色

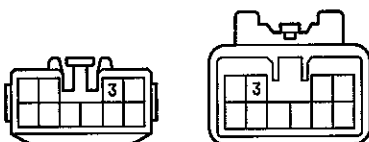

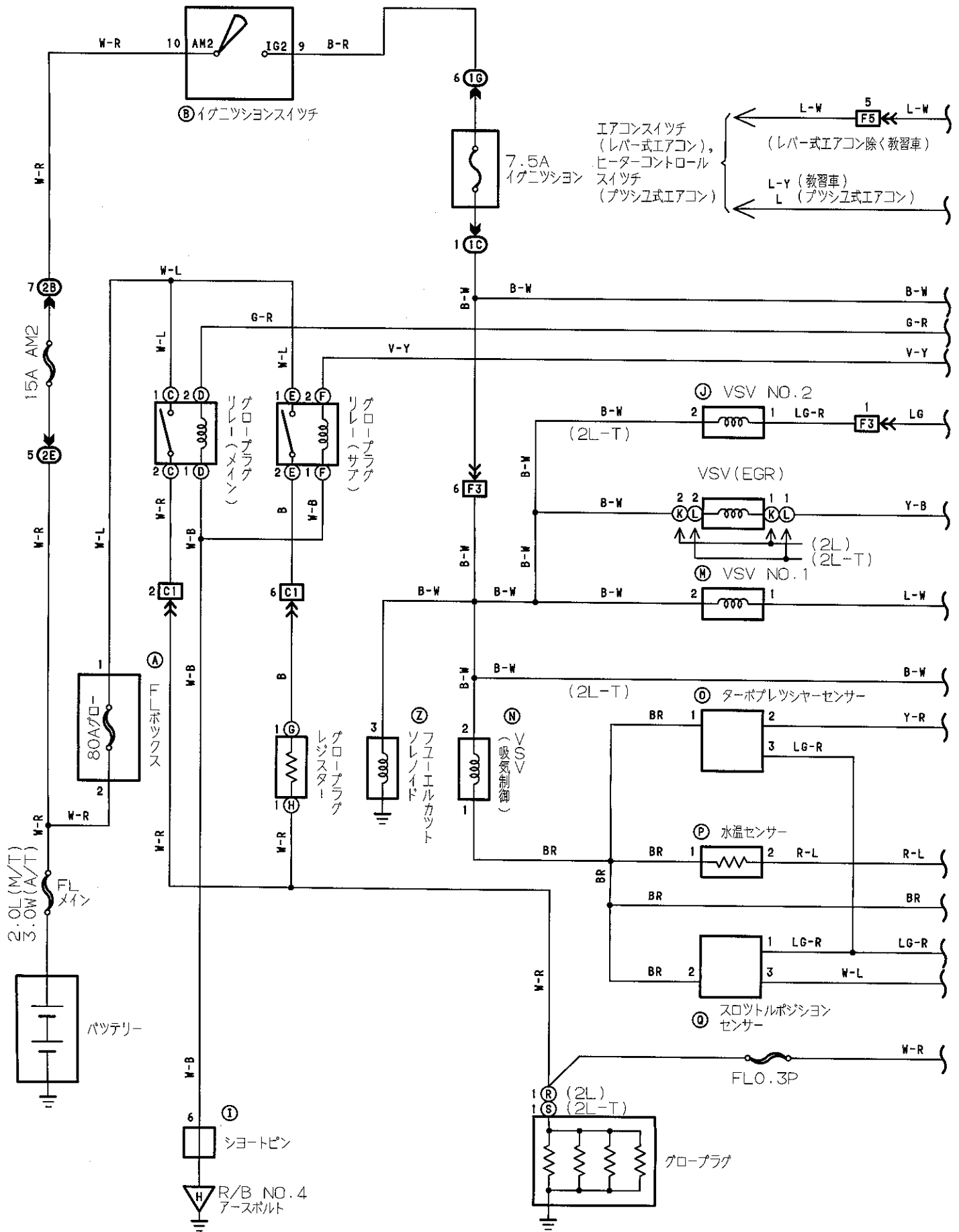



Ⓐ 黒色

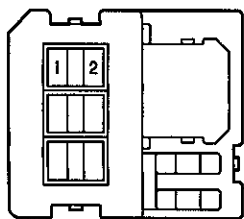

Ⓑ 黒色



Ⓒ 濃灰色



Ⓓ 濃灰色



Ⓔ 灰色



Ⓕ 灰色



Ⓖ Ⓕ Ⓖ



Ⓘ

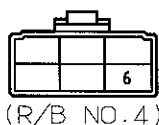

Ⓙ 青色



Ⓚ 茶色



Ⓛ Ⓝ 茶色



Ⓜ 灰色



Ⓡ 濃灰色



Ⓢ 濃緑色



Ⓣ 灰色



Ⓟ 黒色



Ⓡ 濃灰色

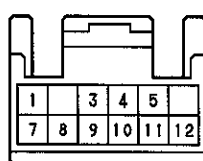

Ⓢ 灰色

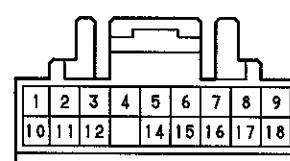

Ⓡ



Ⓜ 青色

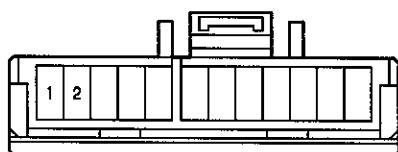

Ⓝ 灰色

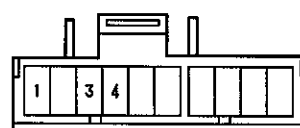

Ⓡ 茶色

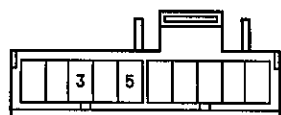

Ⓡ 灰色



Ⓡ 濃灰色

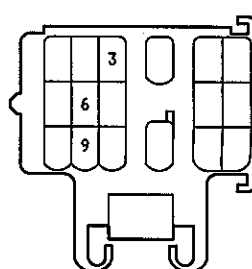

Ⓡ

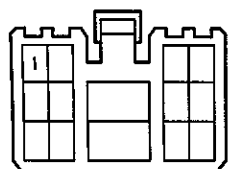

Ⓡ

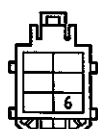

Ⓡ

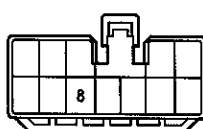

Ⓡ 黒色



Ⓡ 黒色

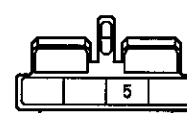

3C 青色

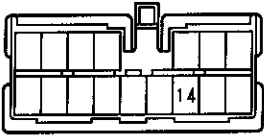

C1 黑色

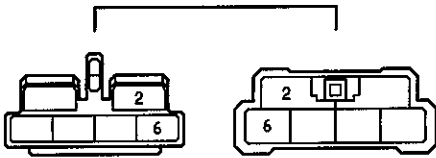

F3 濃灰色

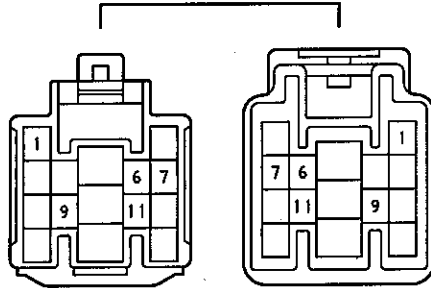

F5 濃灰色

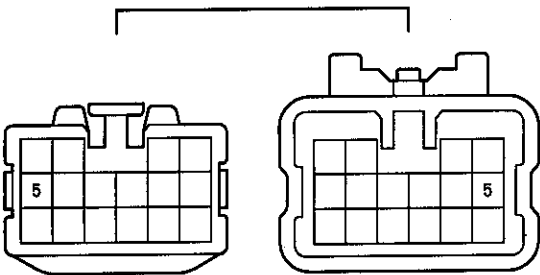

G1

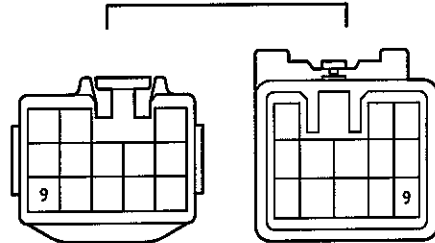

J1 J3

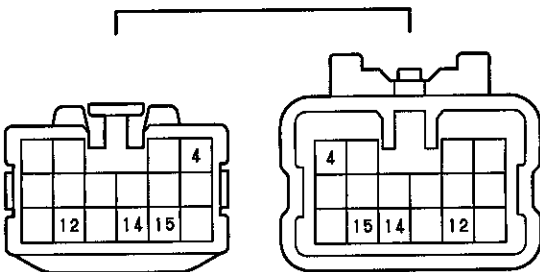



# 排出ガス浄化装置 (3Y-P)

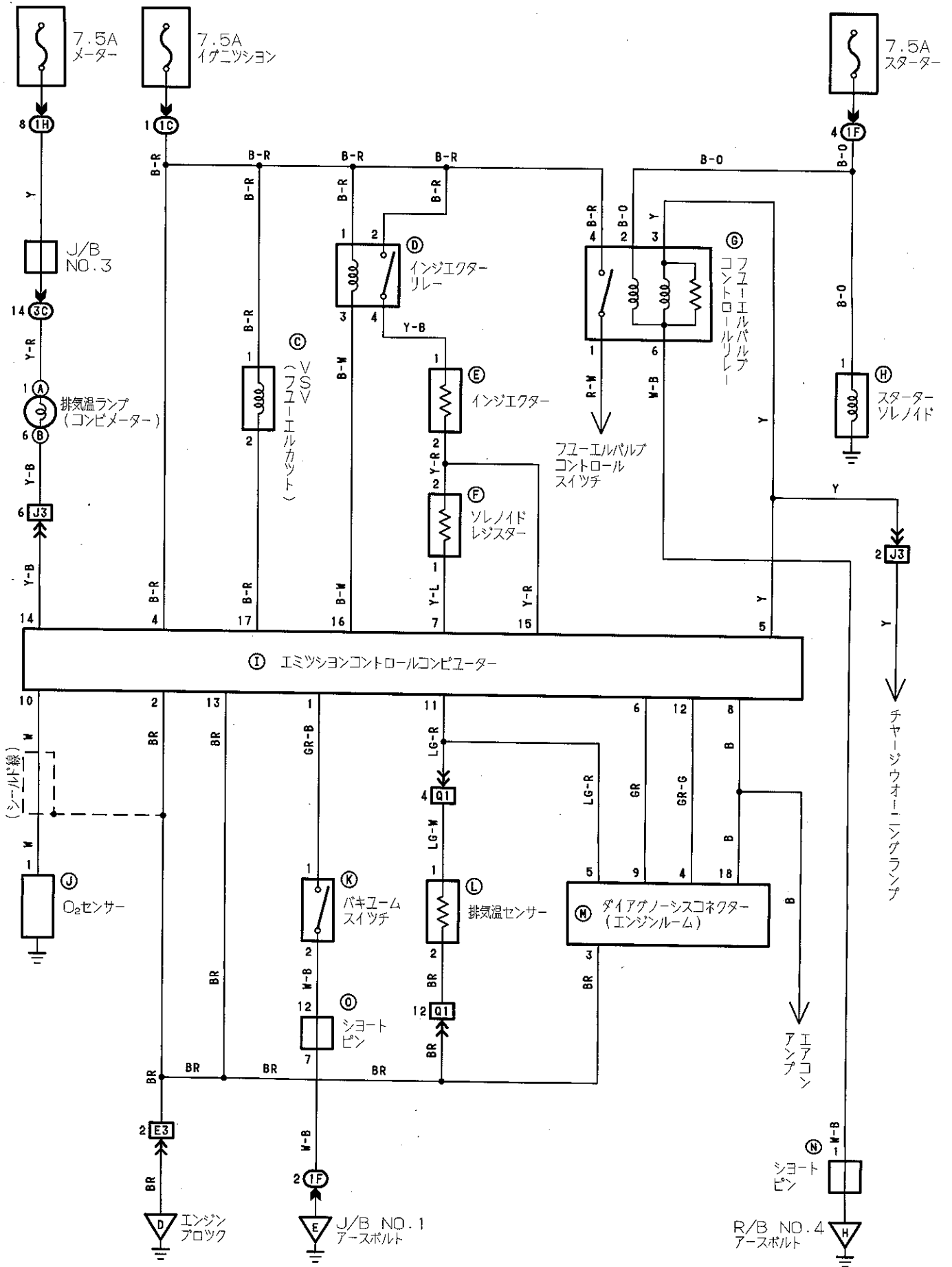

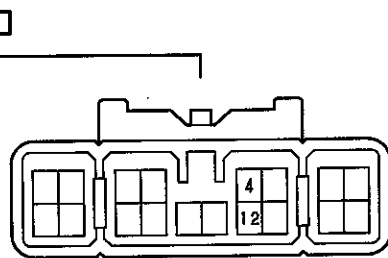
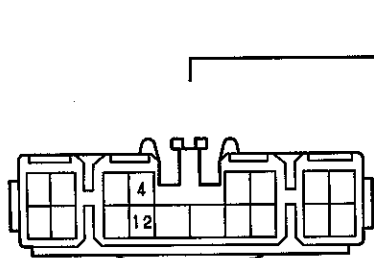
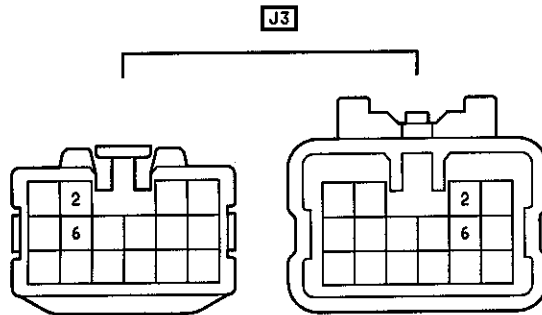
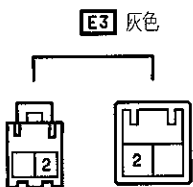
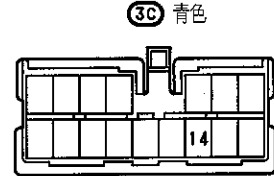
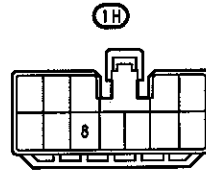
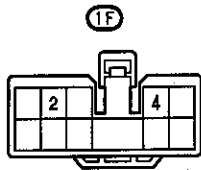
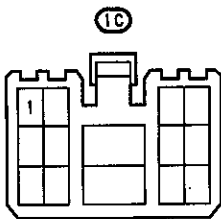
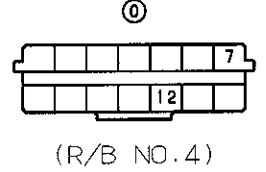
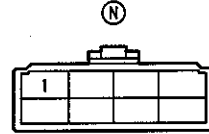
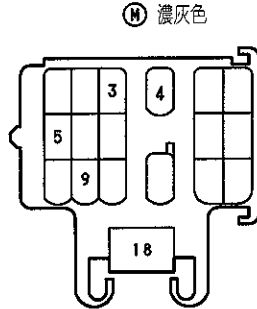
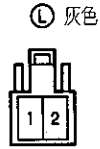
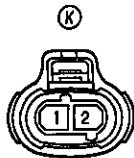
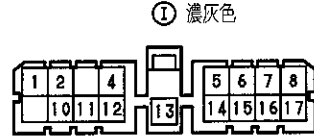
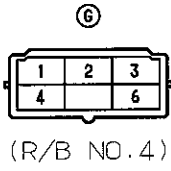
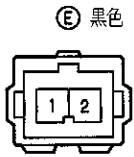
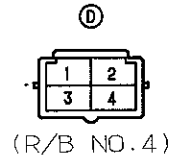
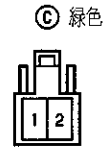
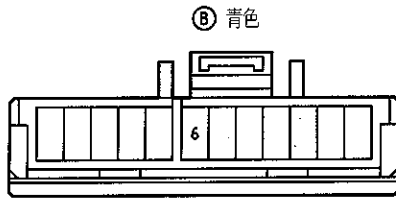
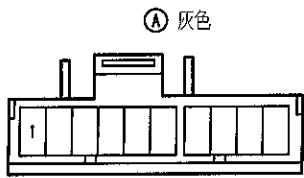



# キヤブレター(3Y-P)

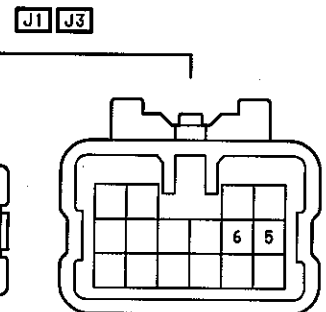
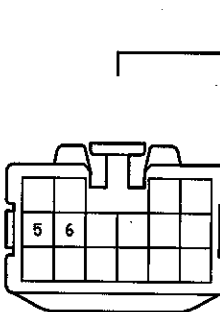
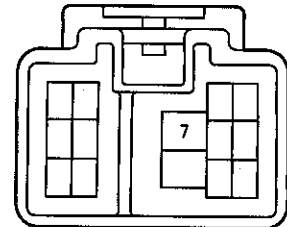
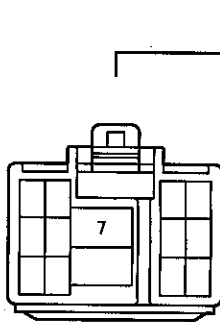
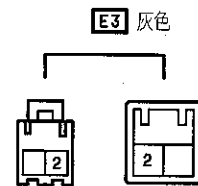
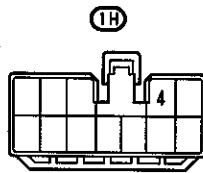
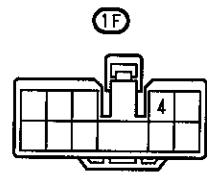
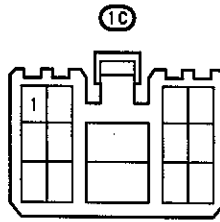
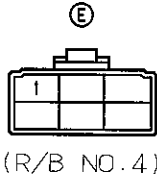
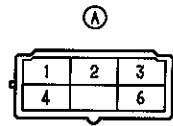
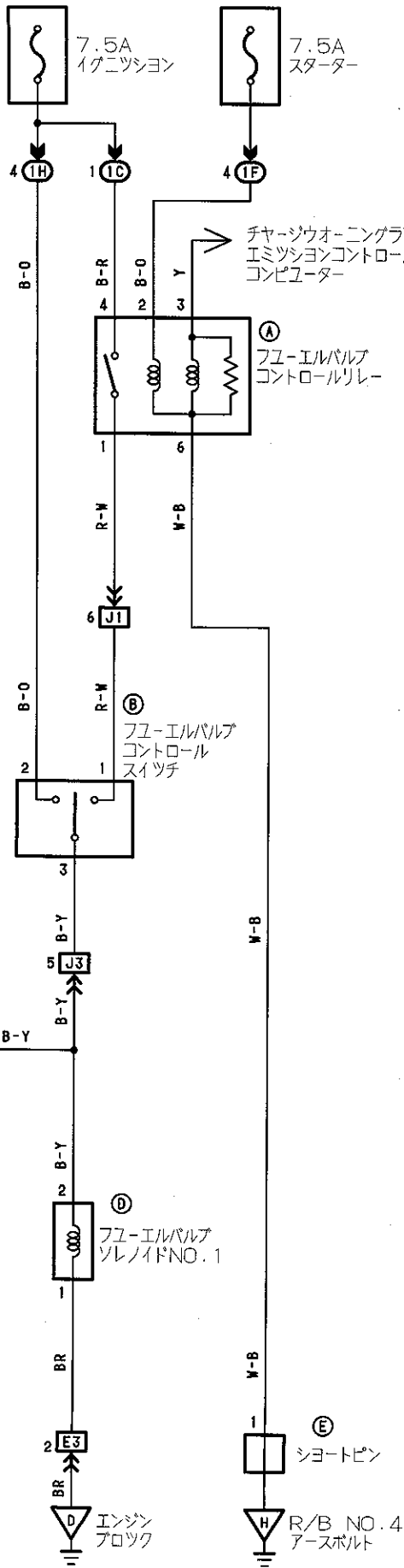

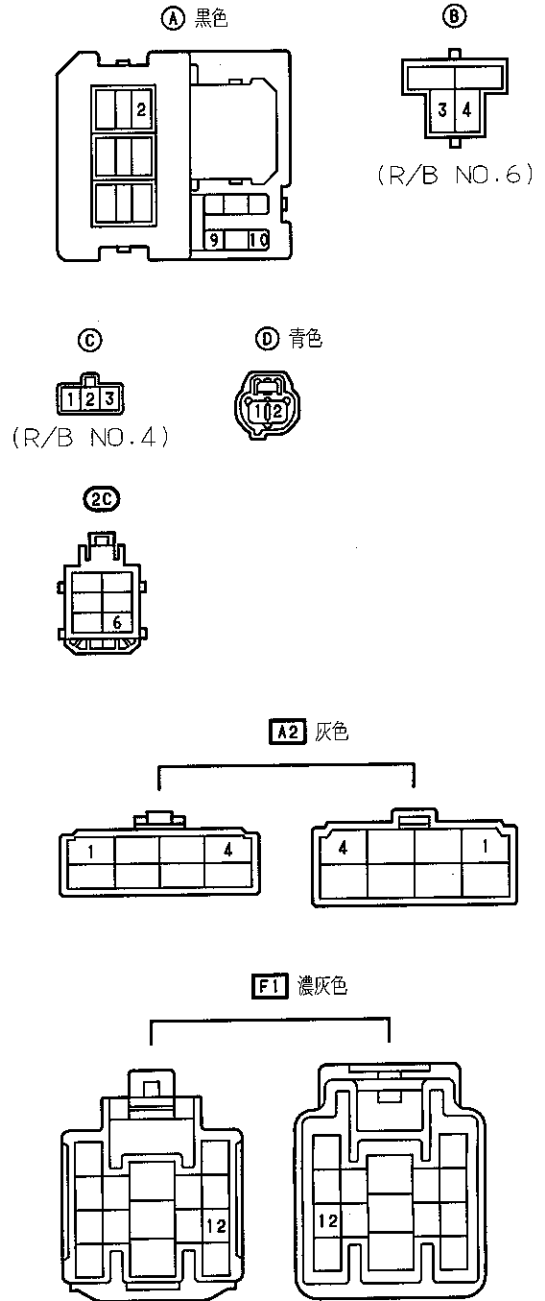
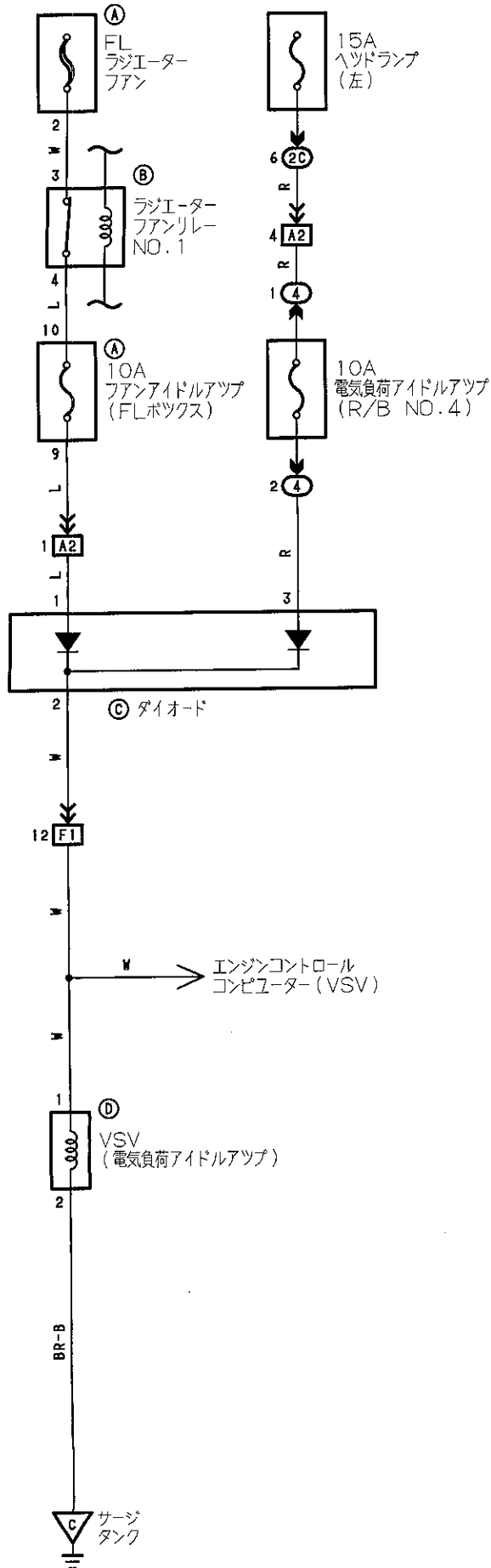



# ヘッドランプ

○ 1G-FE ESCなし  
 △ 1G-FE ESC付き

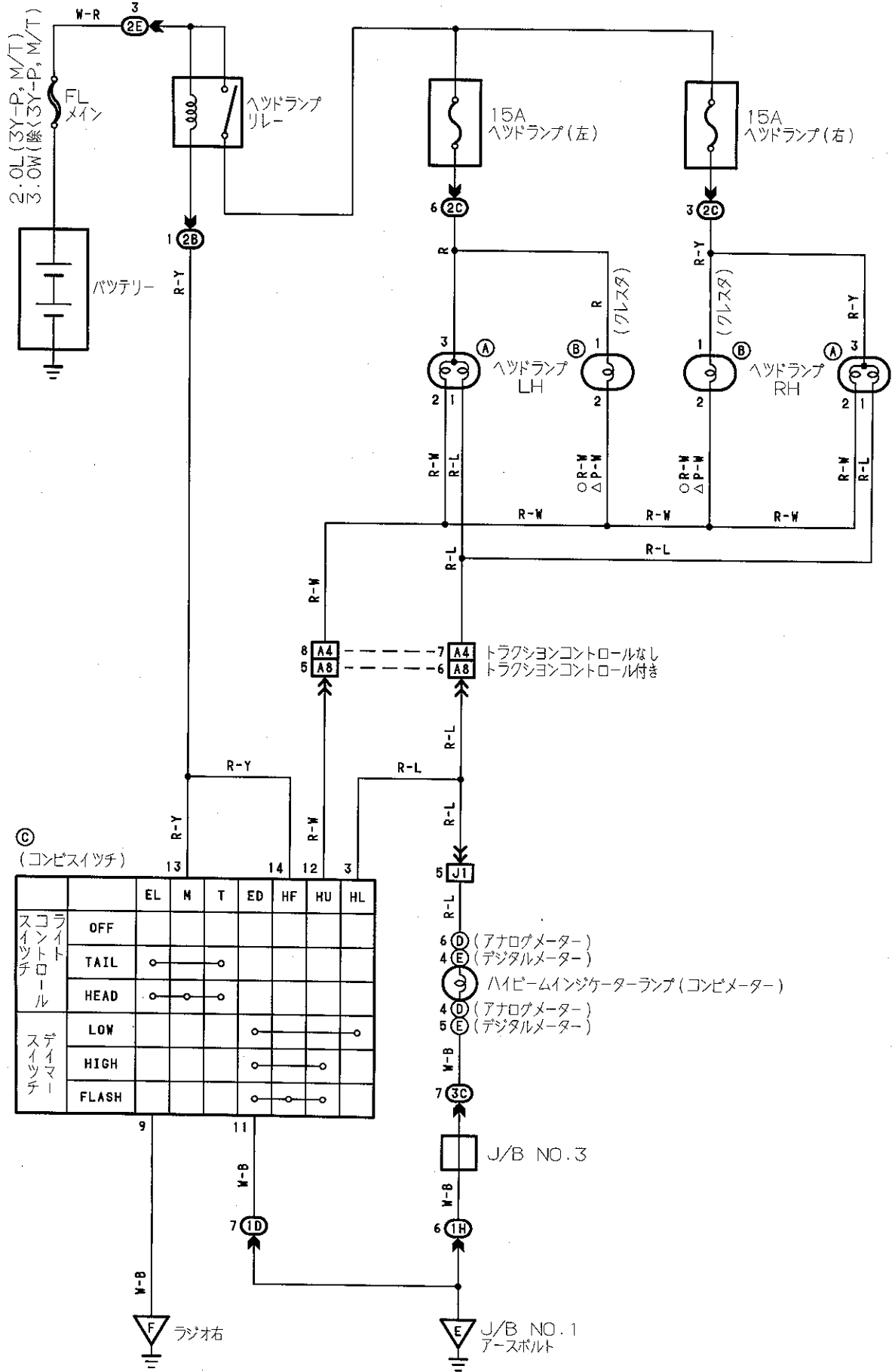

③ (コンビスイッチ)

		EL	N	T	ED	HF	HU	HL
コンビ スイッチ コントロール	OFF							
	TAIL	○	○					
	HEAD	○	○					
スイ ッチ マ ー	LOW				○			○
	HIGH				○			○
	FLASH				○			○

- 6 (D) (アナログメーター)
- 4 (E) (デジタルメーター)
- ハイビームインジケータランプ (コンビメーター)
- 4 (D) (アナログメーター)
- 5 (E) (デジタルメーター)

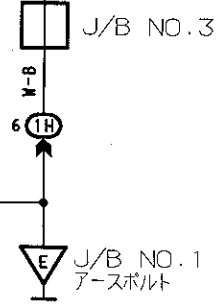

Ⓐ 灰色



Ⓑ 灰色



Ⓒ 黑色

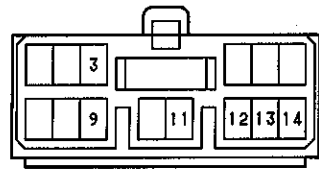

Ⓓ 茶色

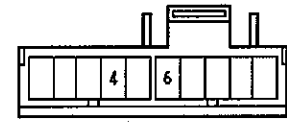

Ⓔ

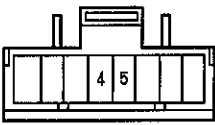

1D

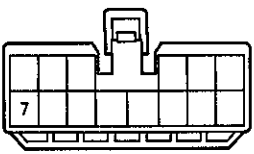

1H

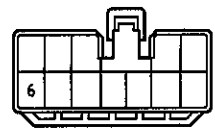

2B 黑色

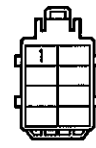

2C

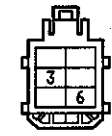

2E 黑色



3C 青色

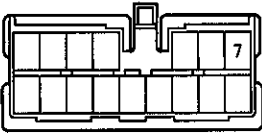

A4 灰色

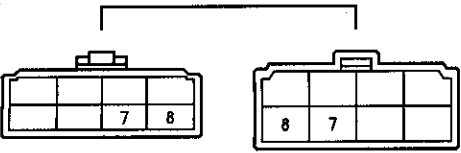

A8 灰色

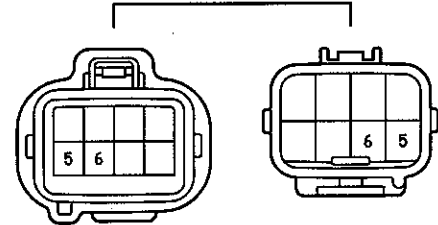

J1

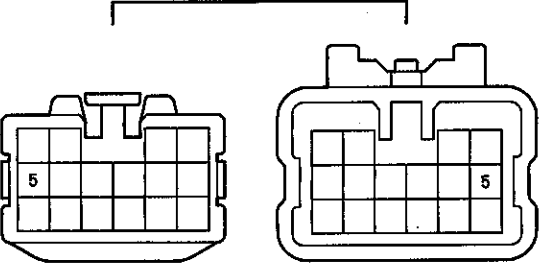

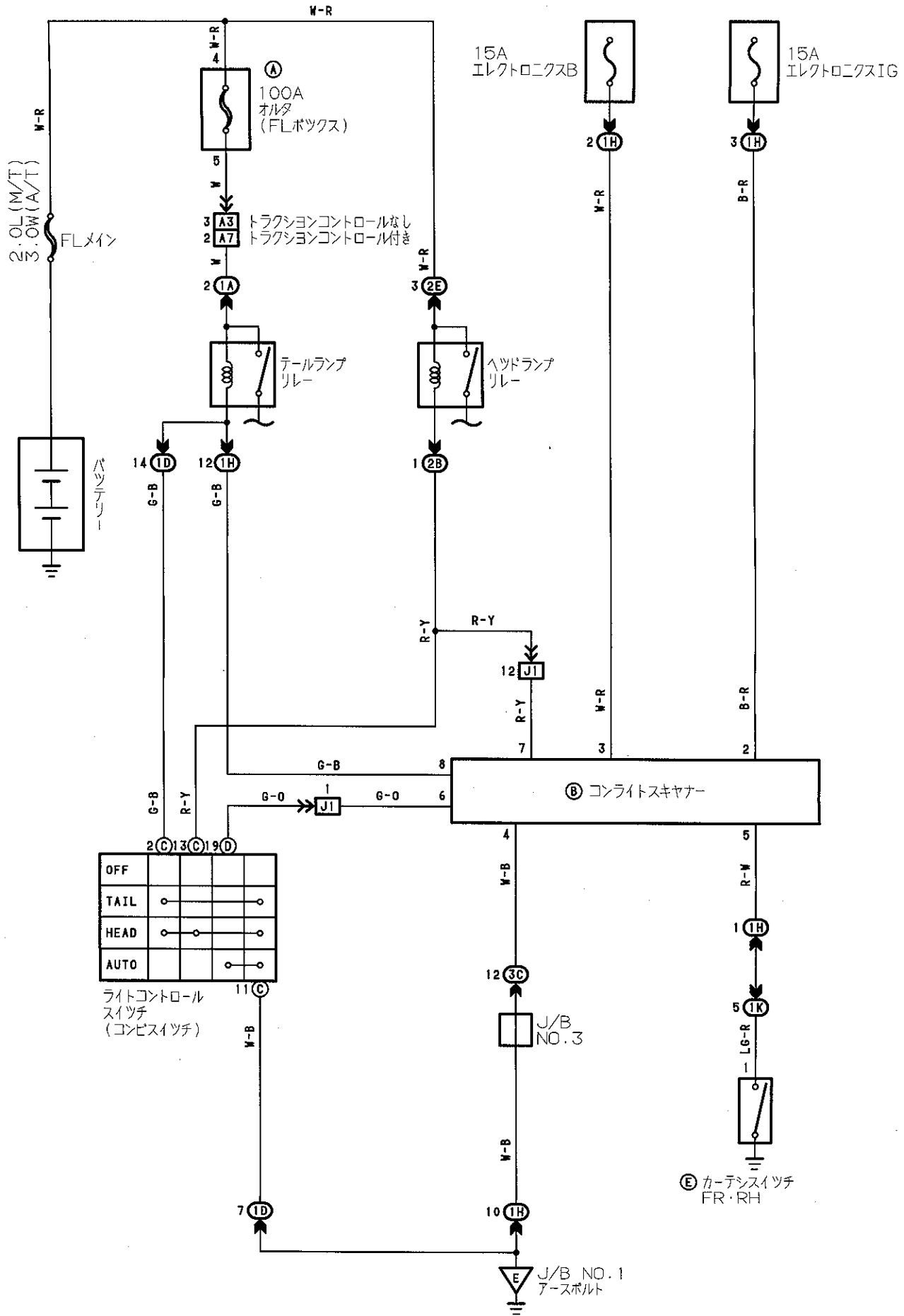

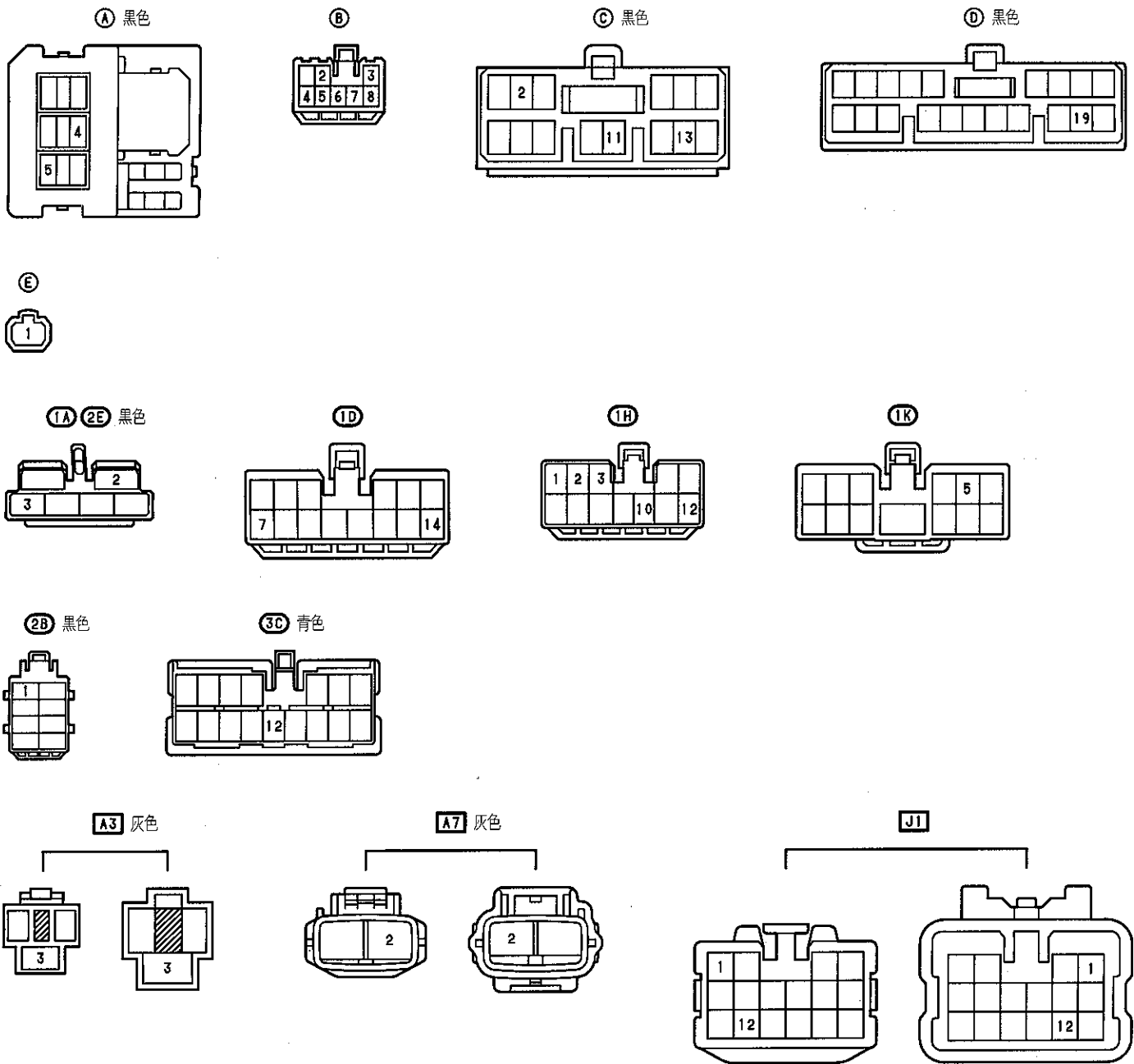

# テールランプ

□ トラクションコントロールなし  
 △ トラクションコントロール付き

○ ランプフェイリアなし  
 △ ランプフェイリア付き

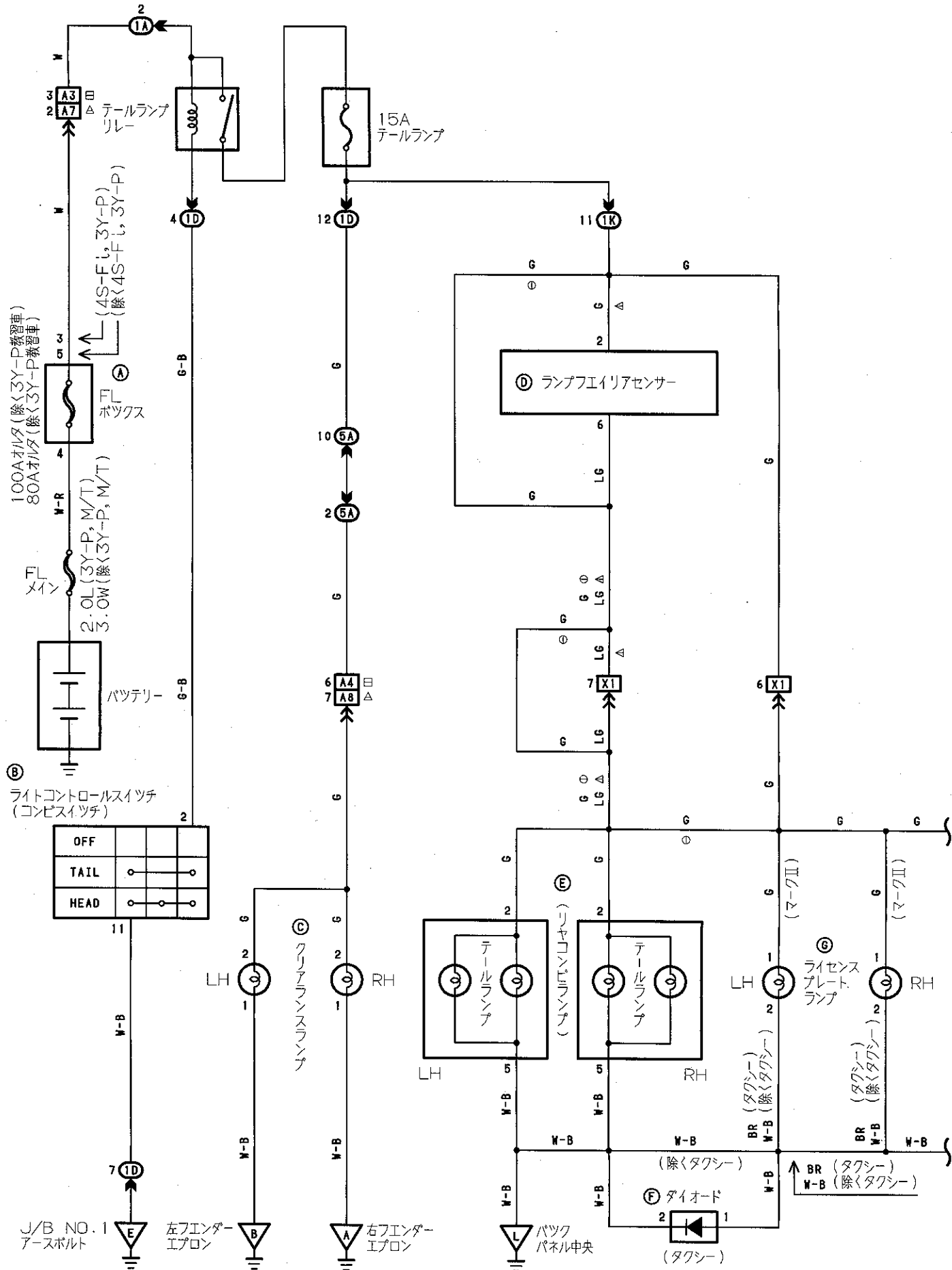

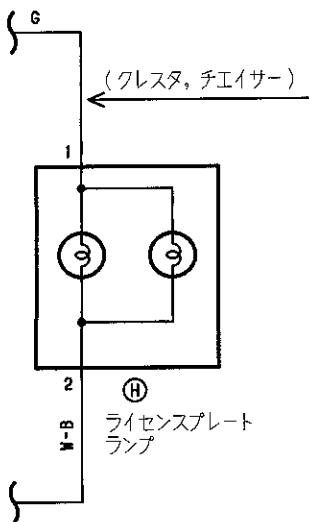
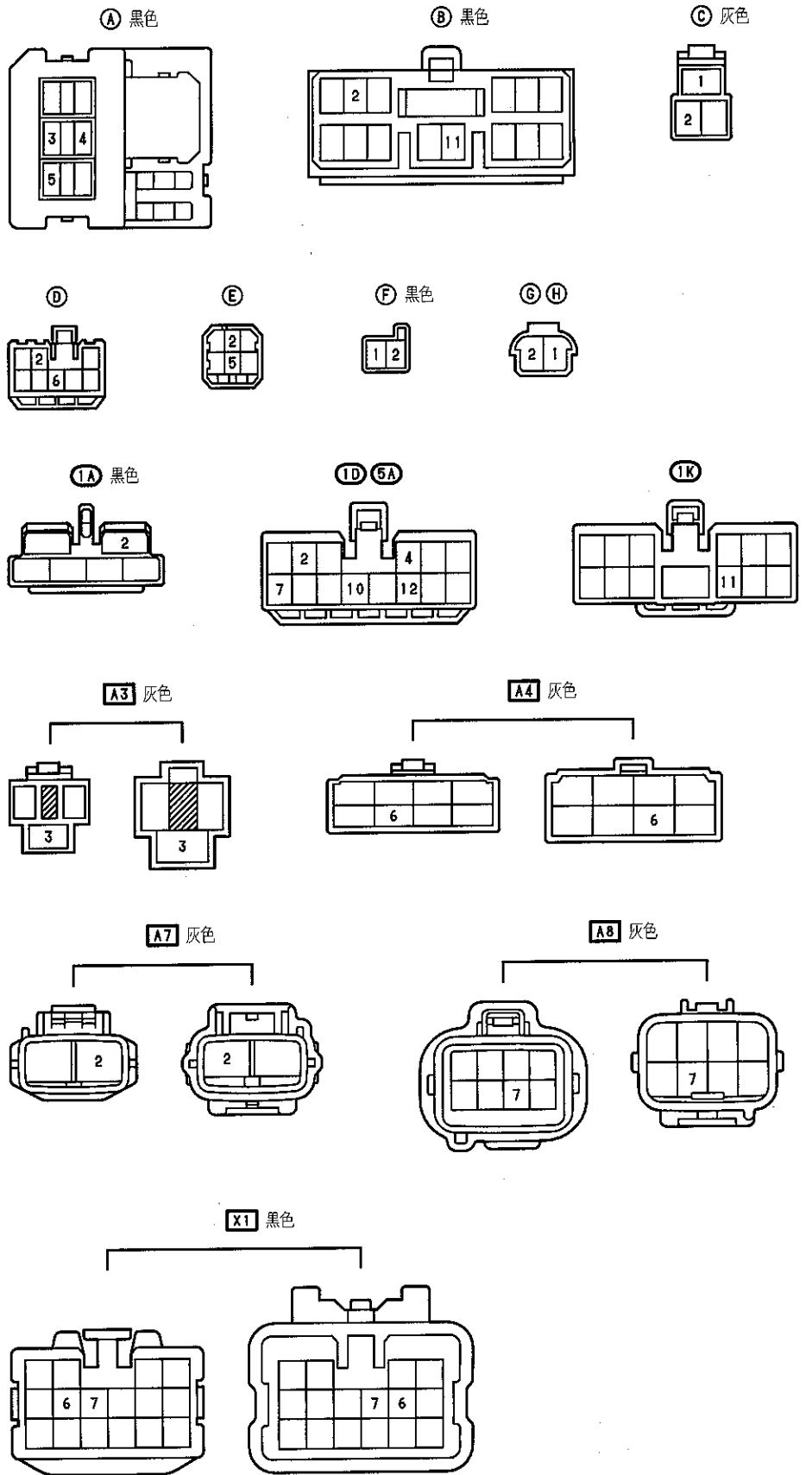



# インテリアランプ

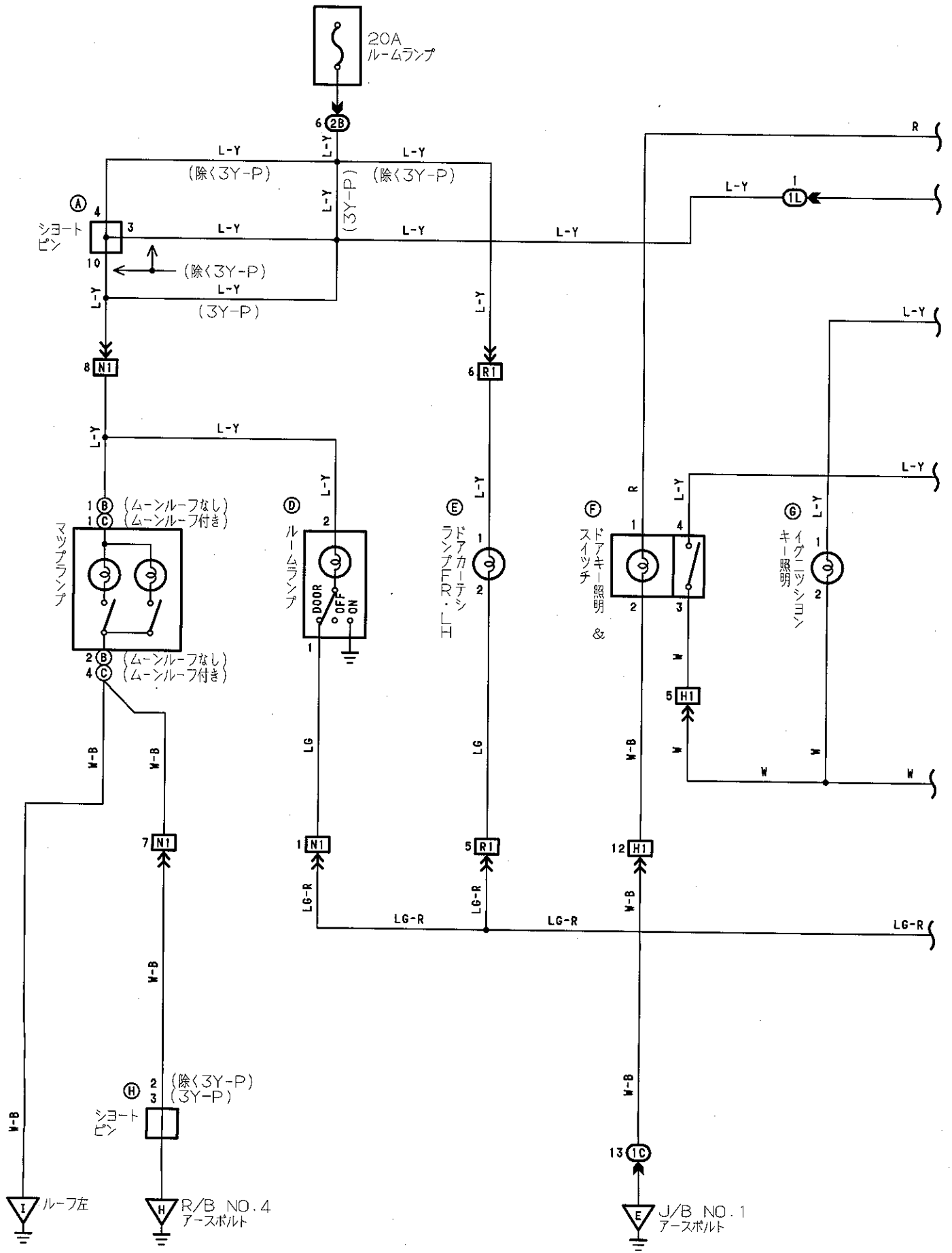





# インテリアランプ

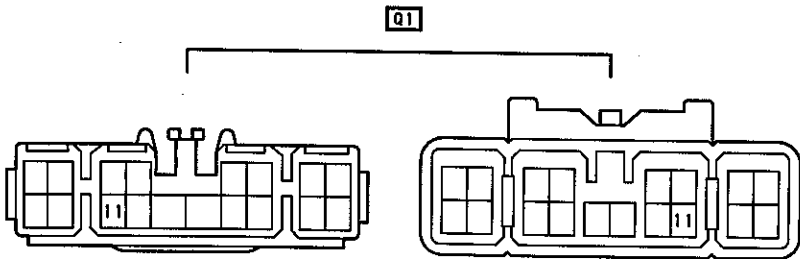
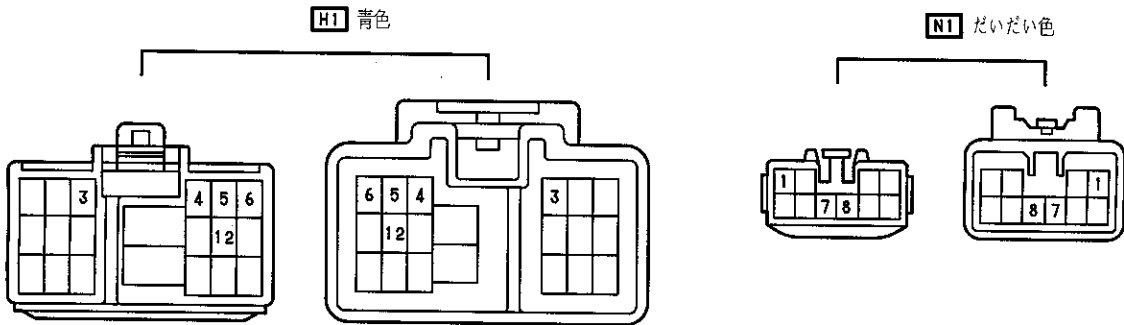
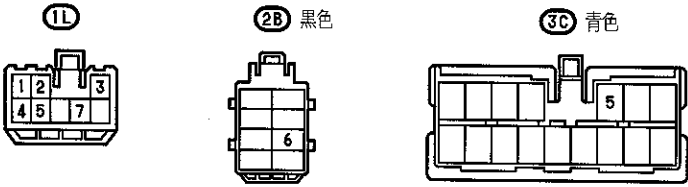
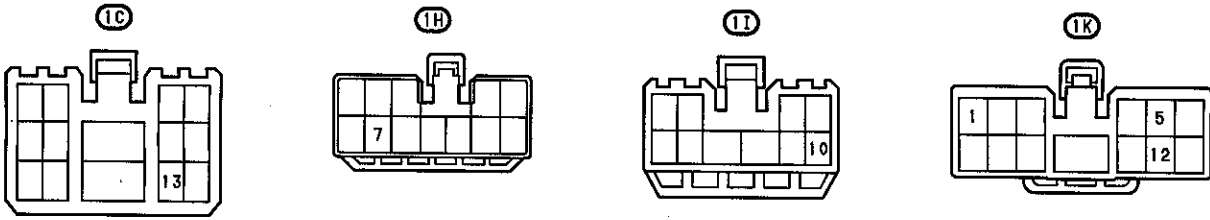
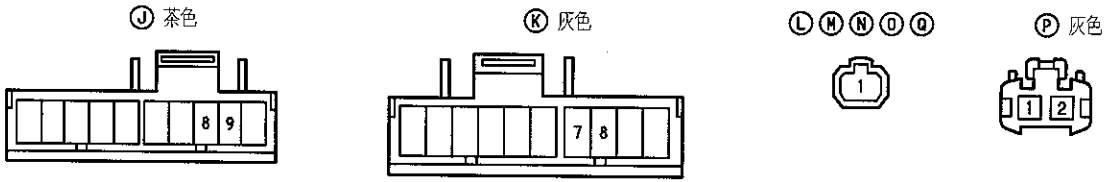
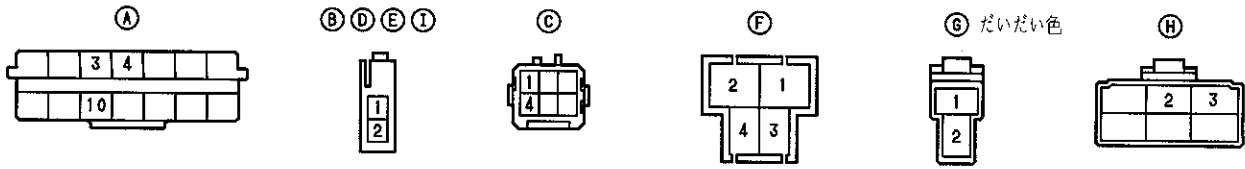

R1 青色

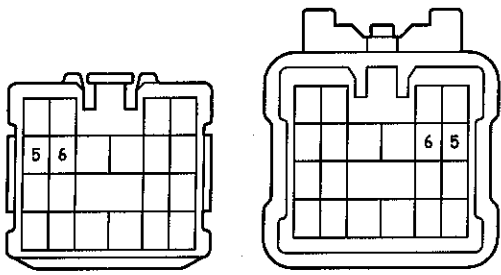

X1 黑色

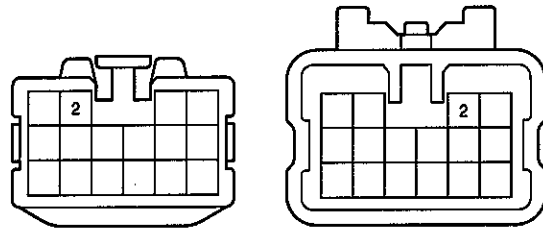

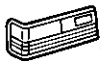

# イルミネーション

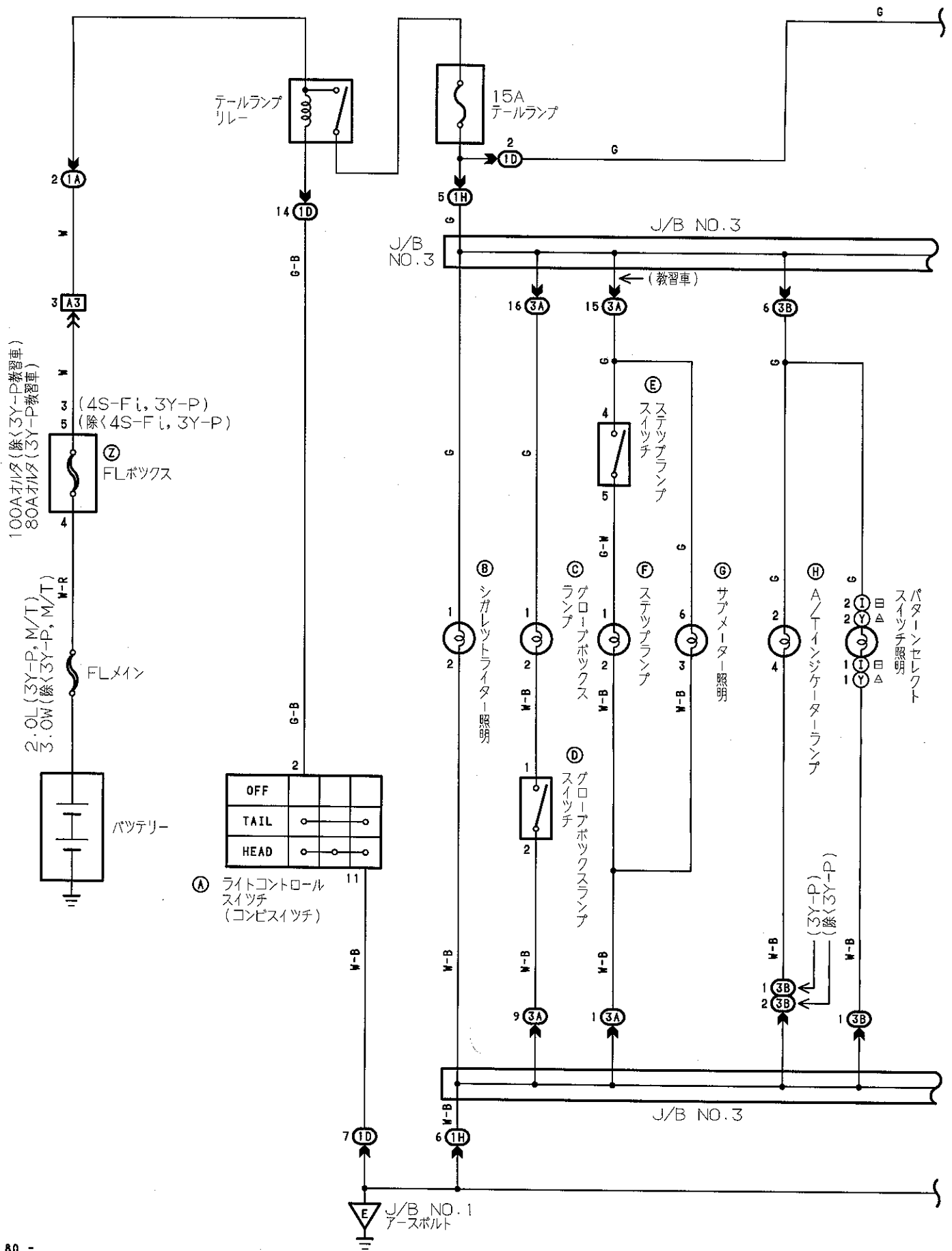

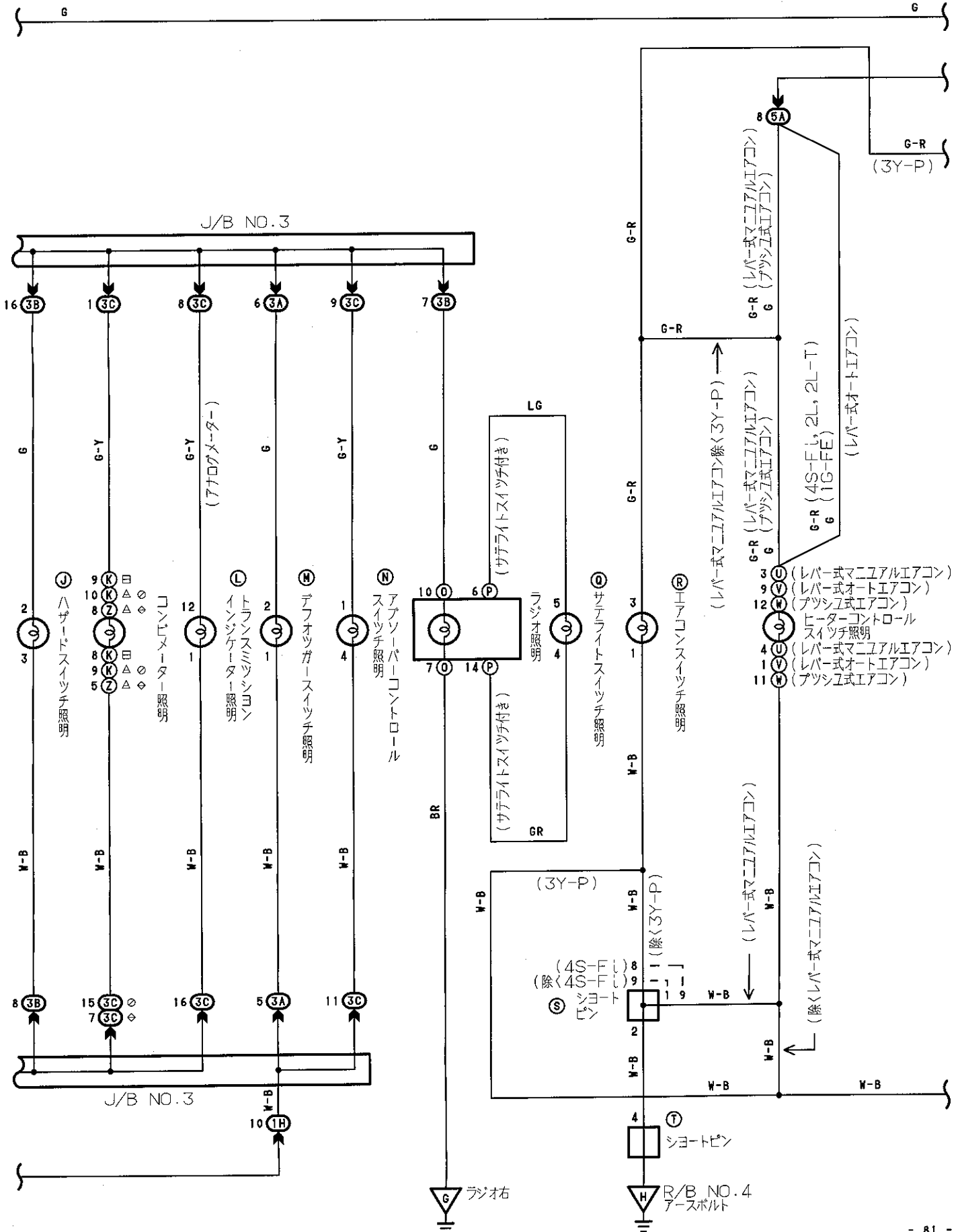

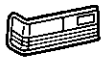

# イルミネーション

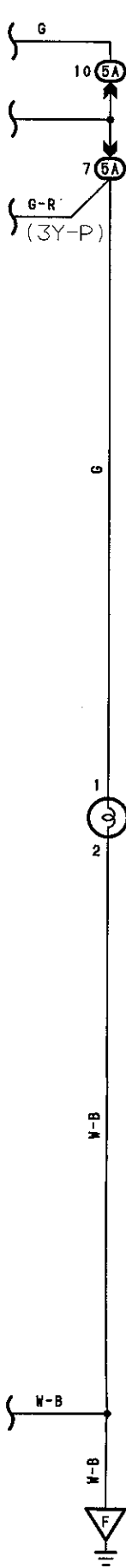

ⓧ エアビュリアフアイアー  
スイッチ照明

Ⓐ 黒色

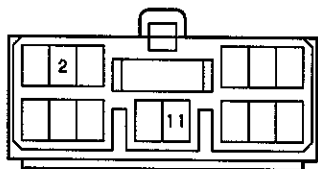

Ⓑ 青色



Ⓒ Ⓕ 灰色



Ⓓ



Ⓔ

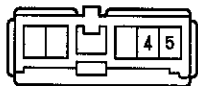

Ⓖ



Ⓗ 青色



Ⓘ



Ⓙ

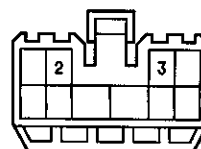

Ⓚ 茶色

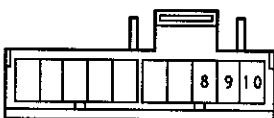

Ⓛ

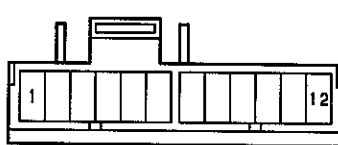

Ⓜ 黒色

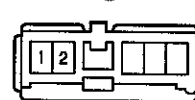

Ⓝ



Ⓞ

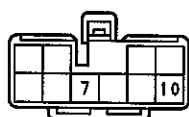

Ⓟ

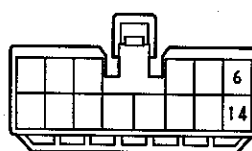

Ⓠ

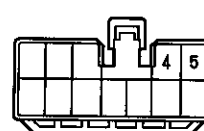

Ⓡ 青色



Ⓢ



Ⓣ



Ⓤ 青色

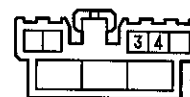

Ⓡ 青色

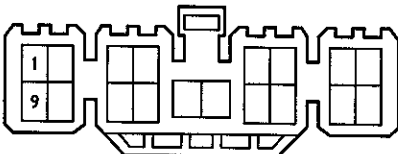

Ⓢ 青色

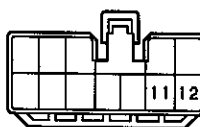

ⓧ 黒色



Ⓨ



Ⓩ

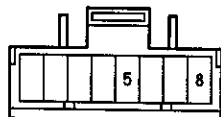

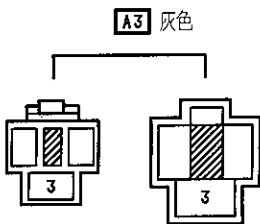
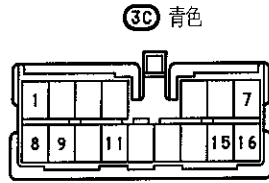
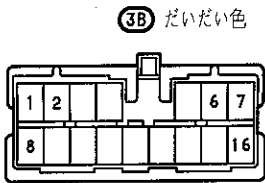
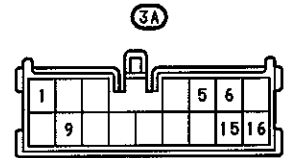
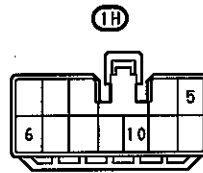
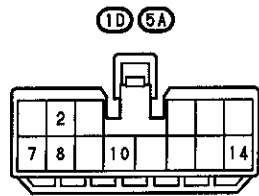
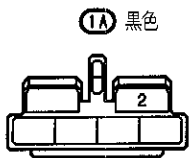



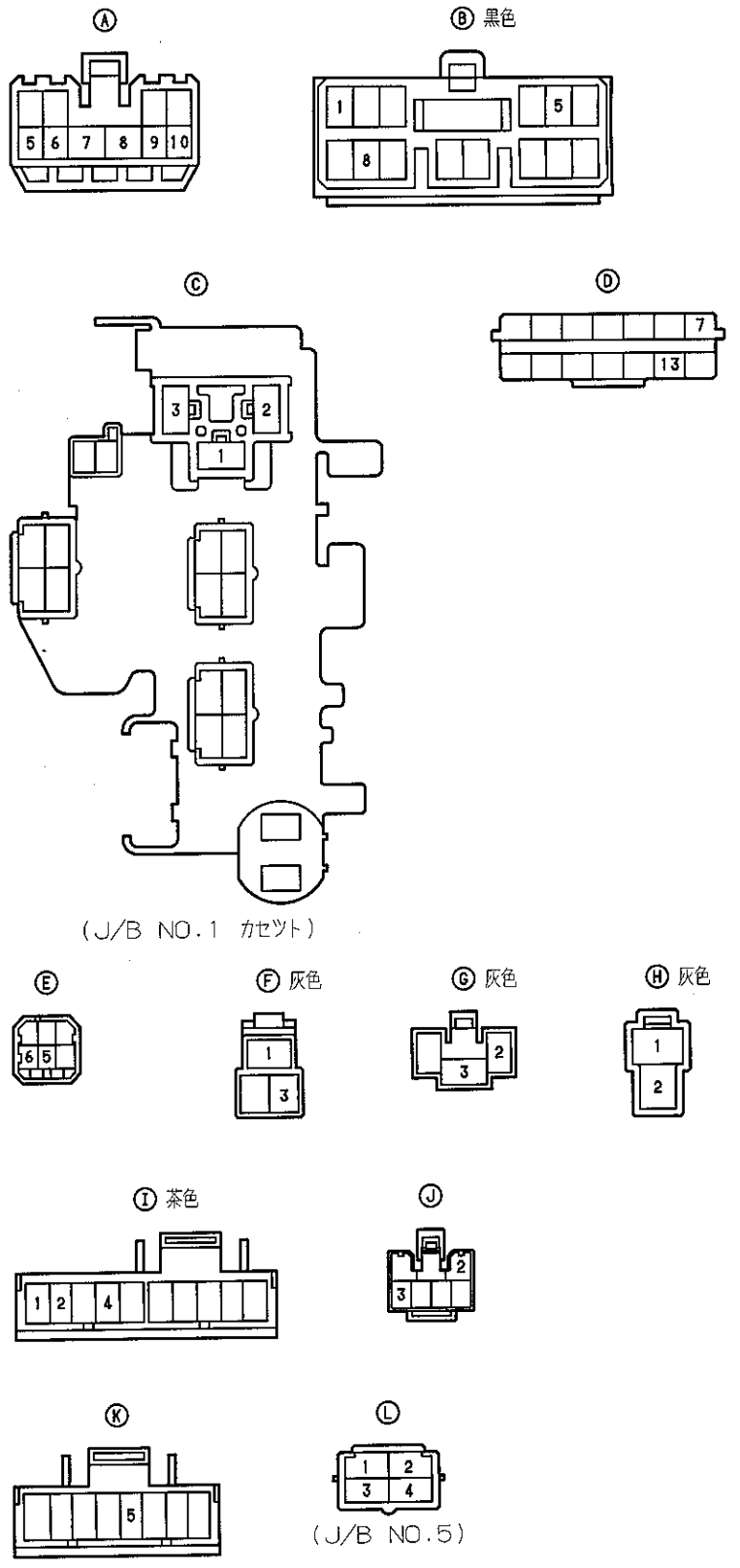
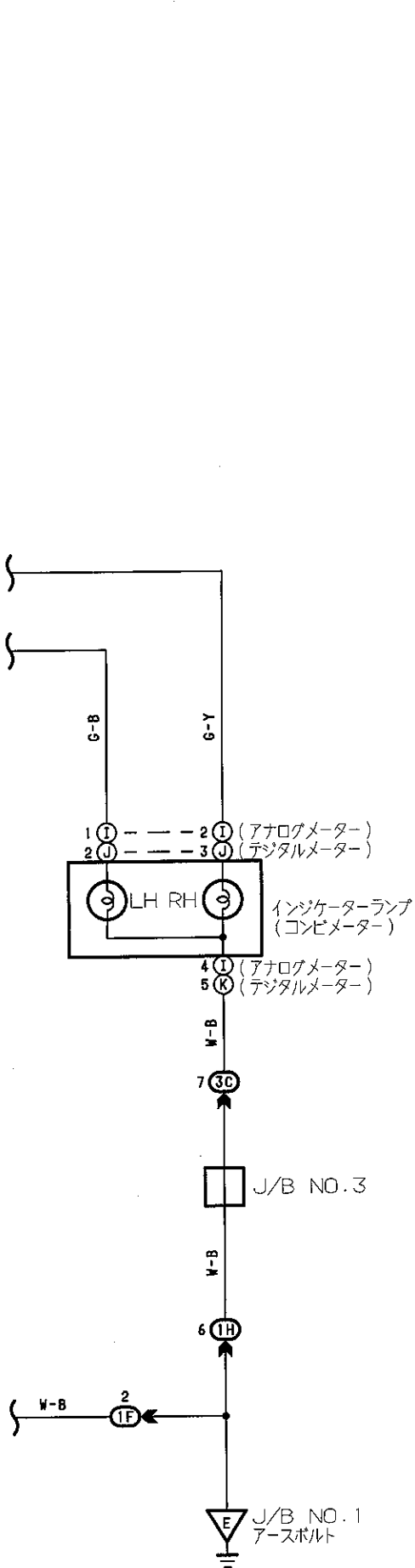



# ターンシグナル & ハザード

①A 黒色

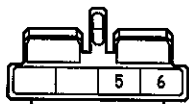

①D

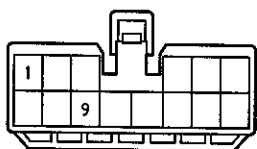

①F

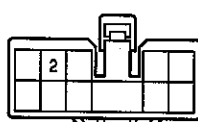

①H

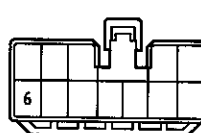

①J

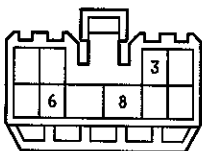

①K

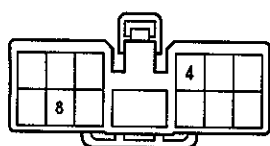

②B 黒色

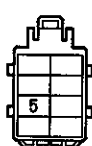

③C 青色

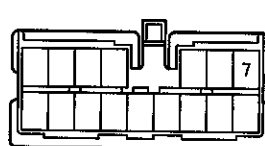

A4 灰色

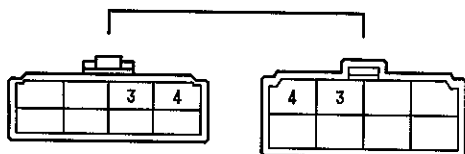

A8 灰色

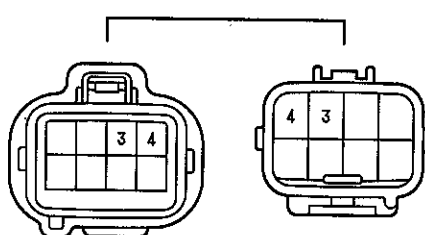

J1 J3

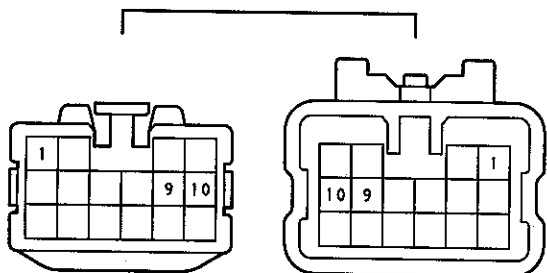

X1 黒色

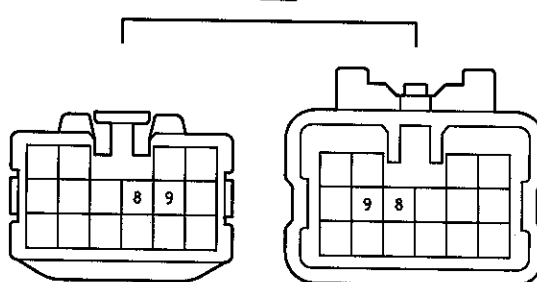

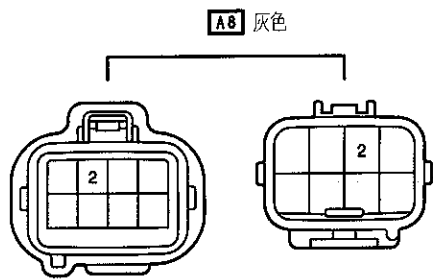
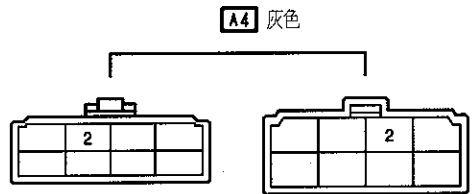
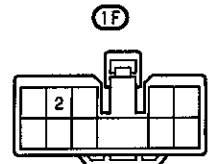
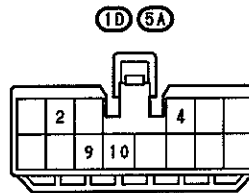
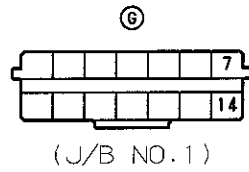
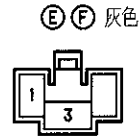
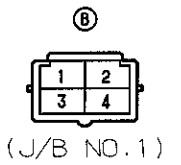
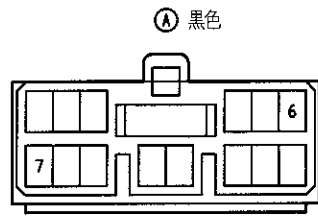
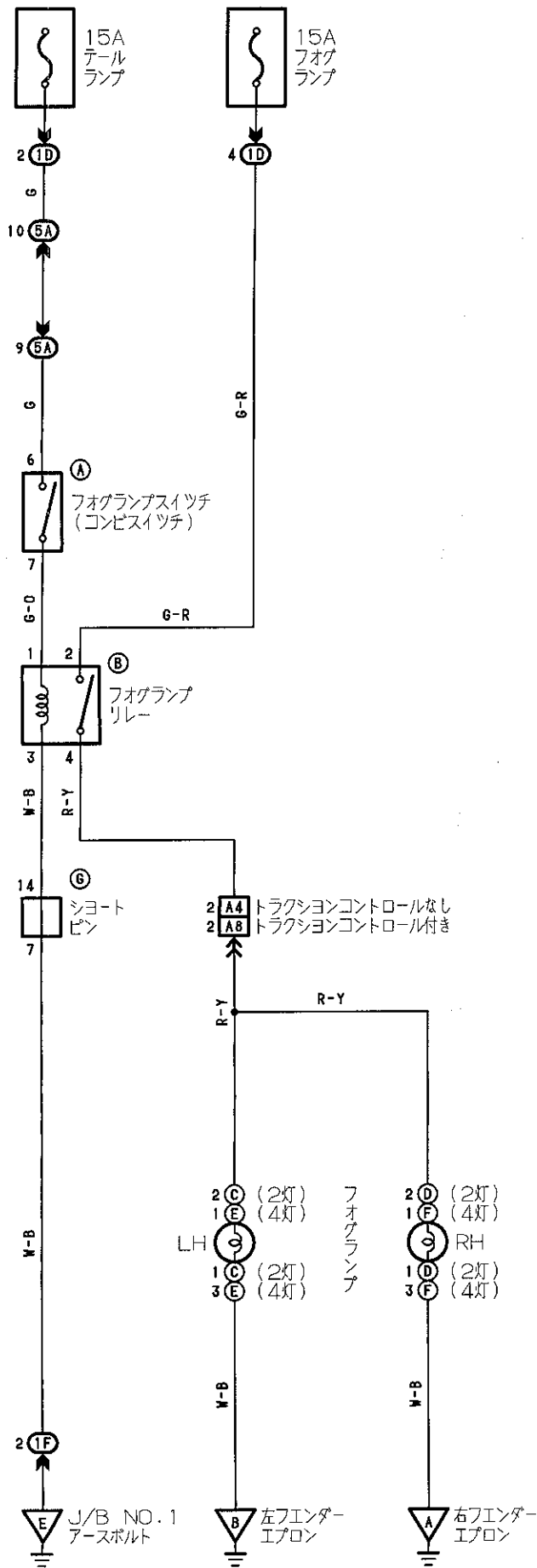



# バックアップランプ

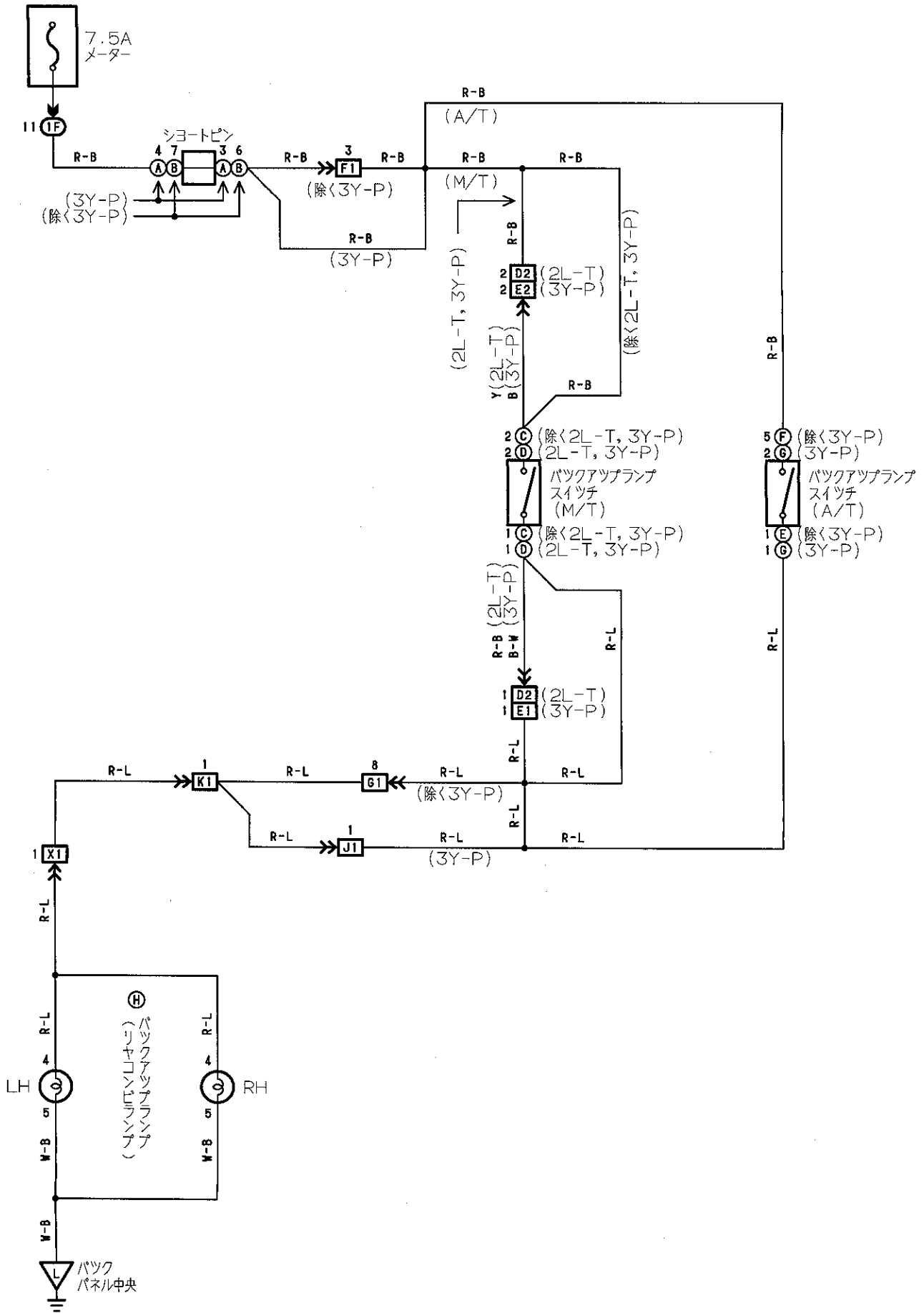

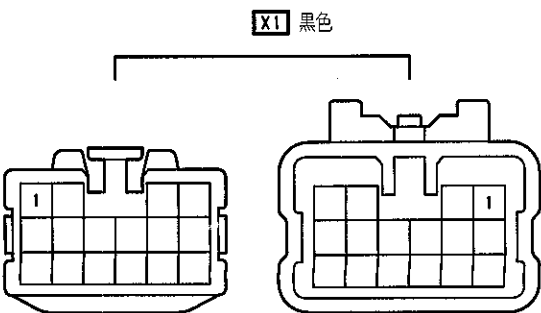
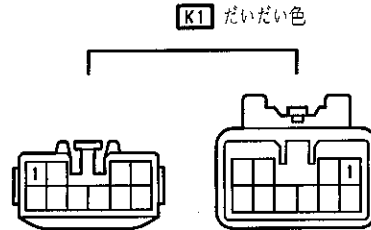
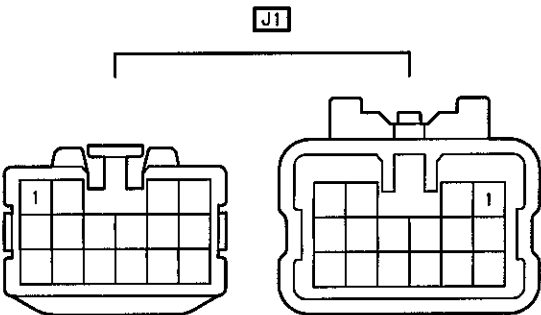
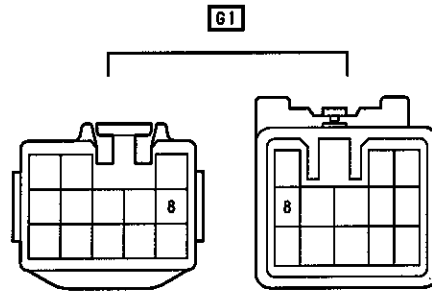
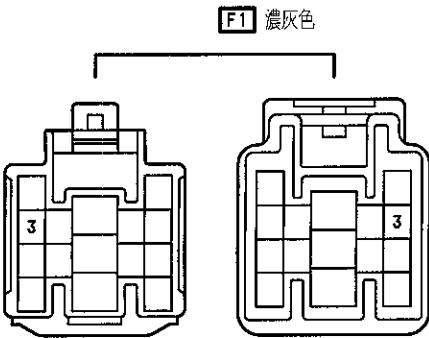
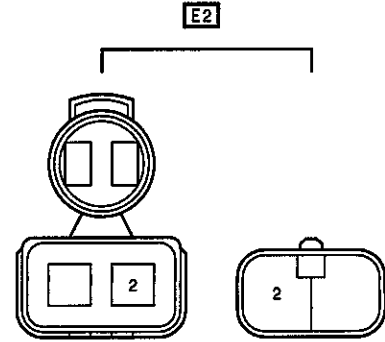
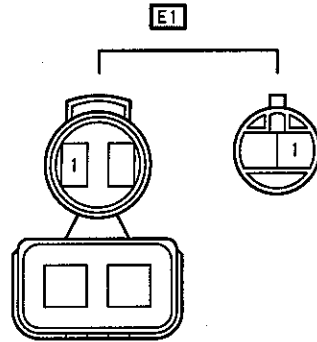
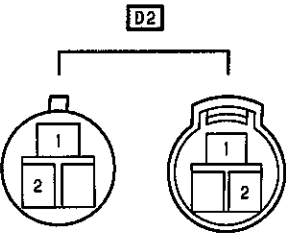
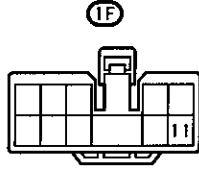
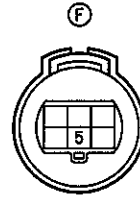
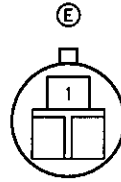
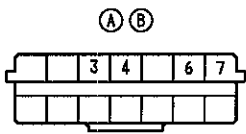

# フロントワイパー & ウォッシャー

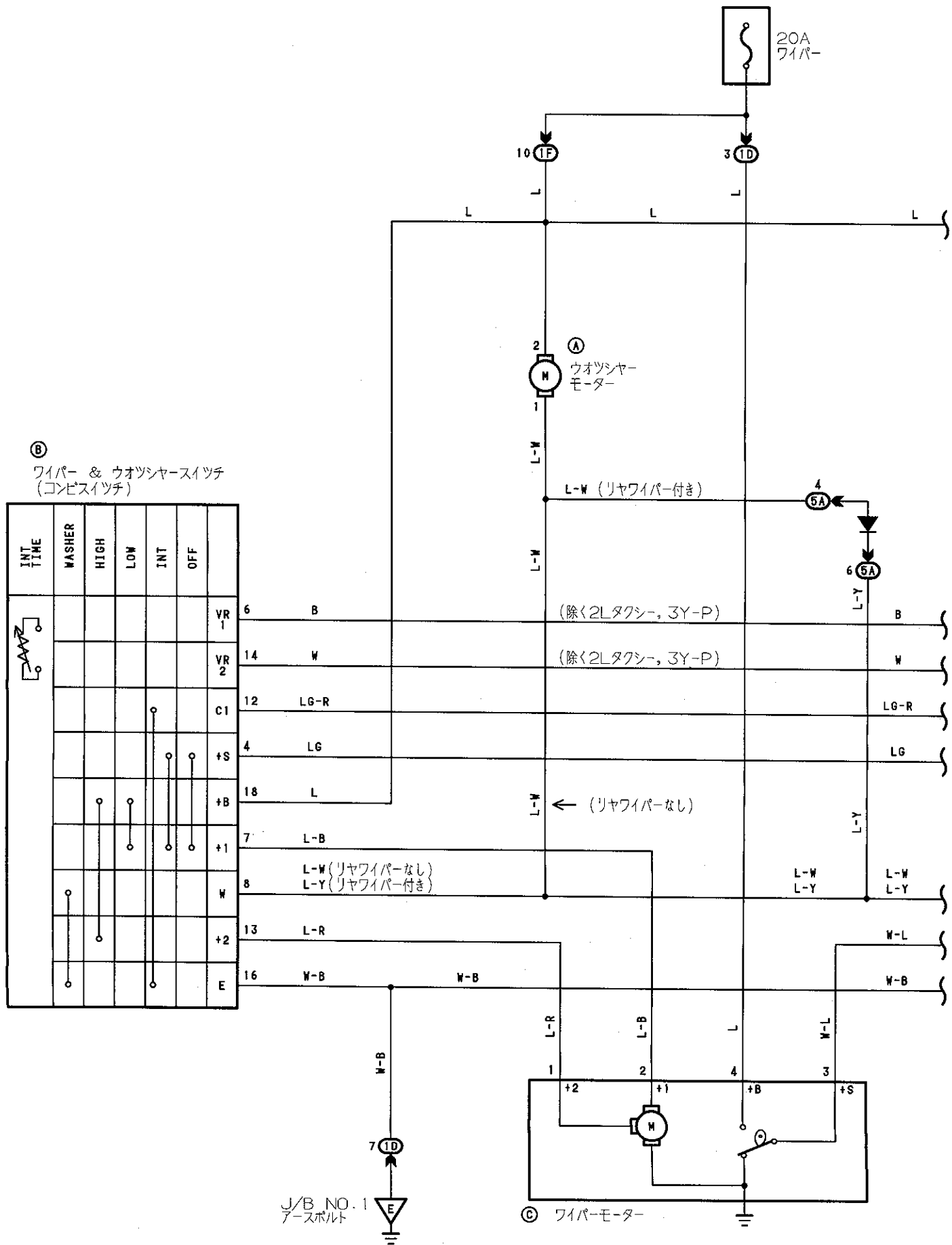

Ⓐ 青色



Ⓑ 黒色

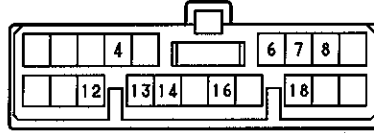

Ⓒ 黒色



Ⓓ

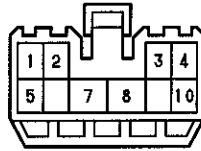

ⓓ Ⓞ 5A

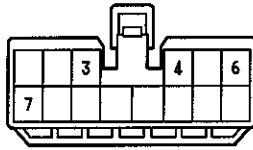

ⓓ 1F

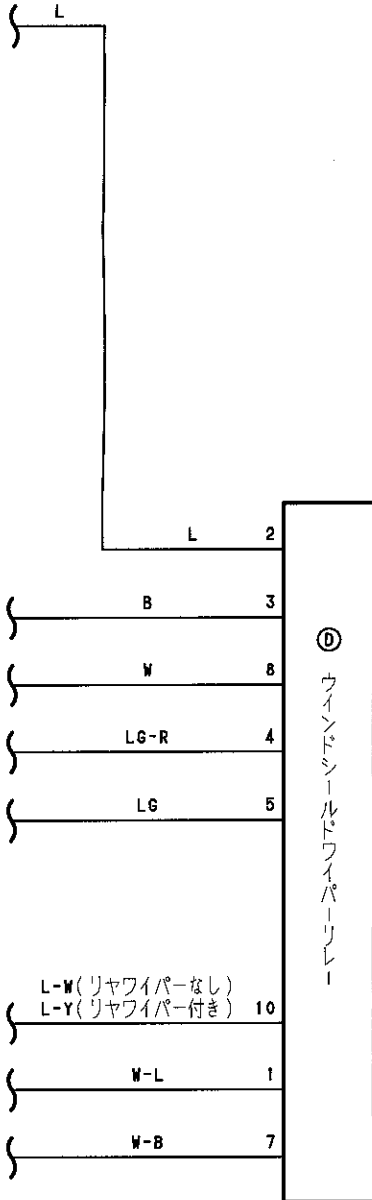
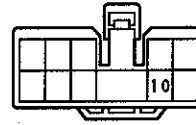



# リヤワイパー & ウォッシャー

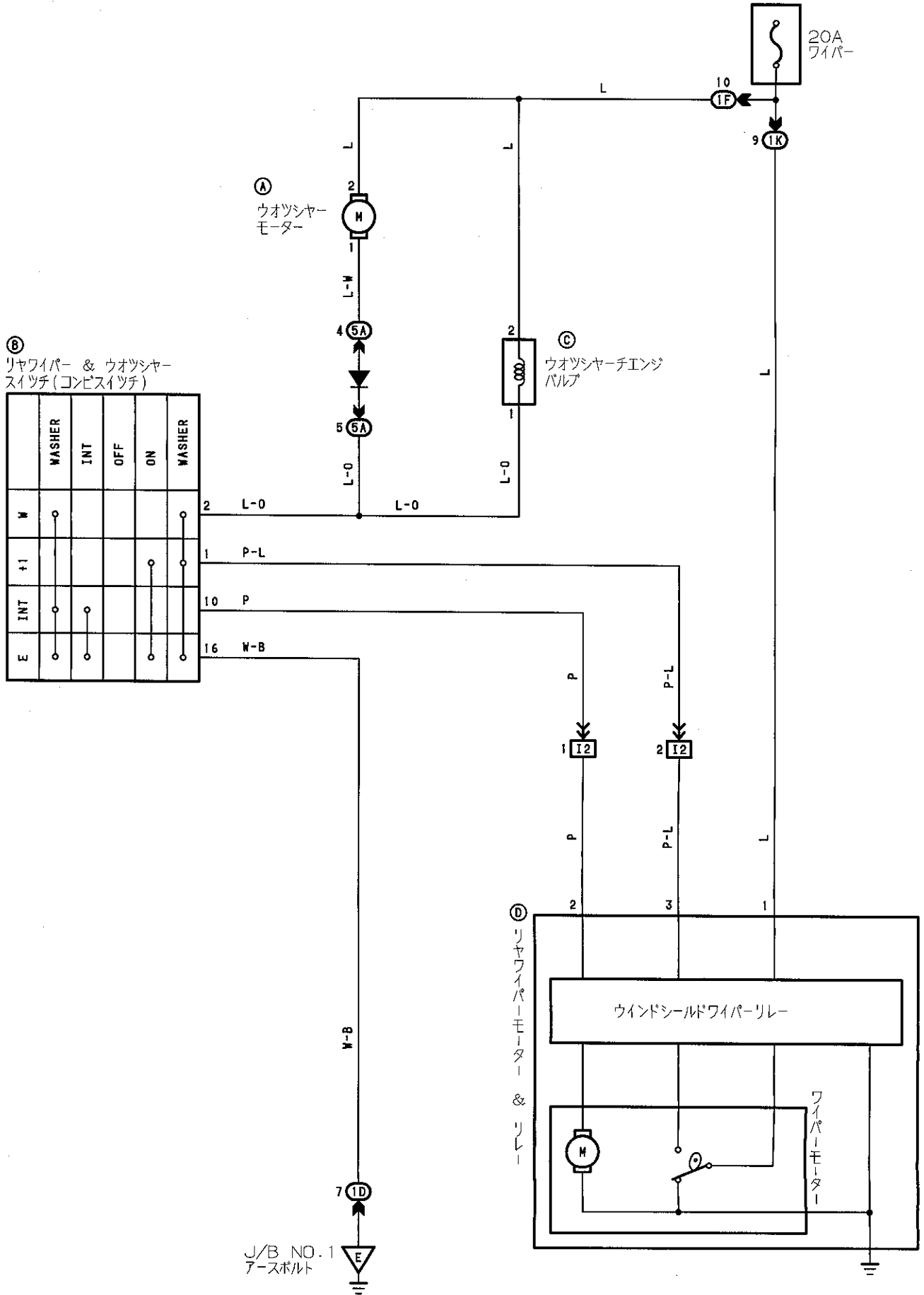

Ⓐ 青色

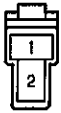

Ⓑ 黒色

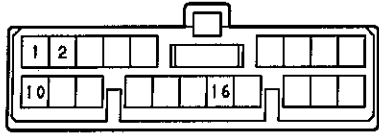

Ⓒ 灰色



Ⓓ



ⓓ ⓔ

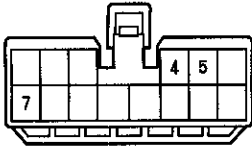

ⓕ

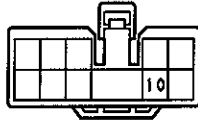

ⓖ

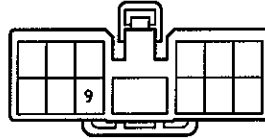

ⓗ

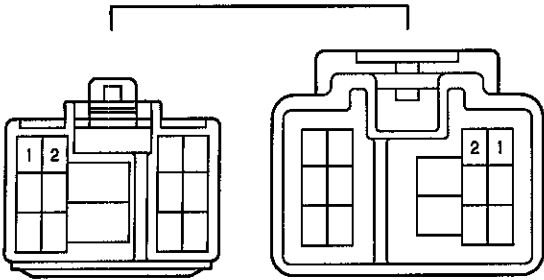



# パワーウィンドウ

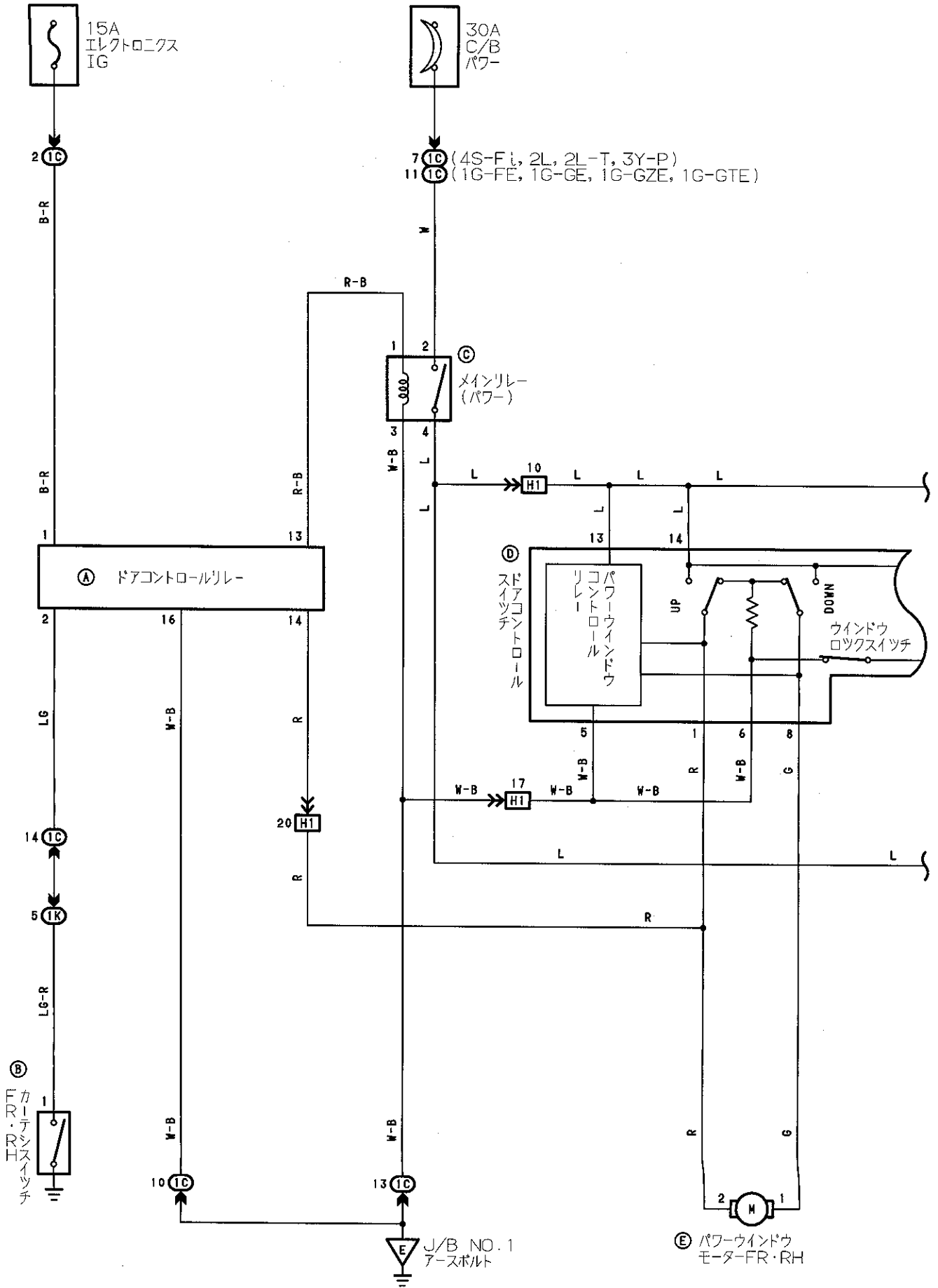

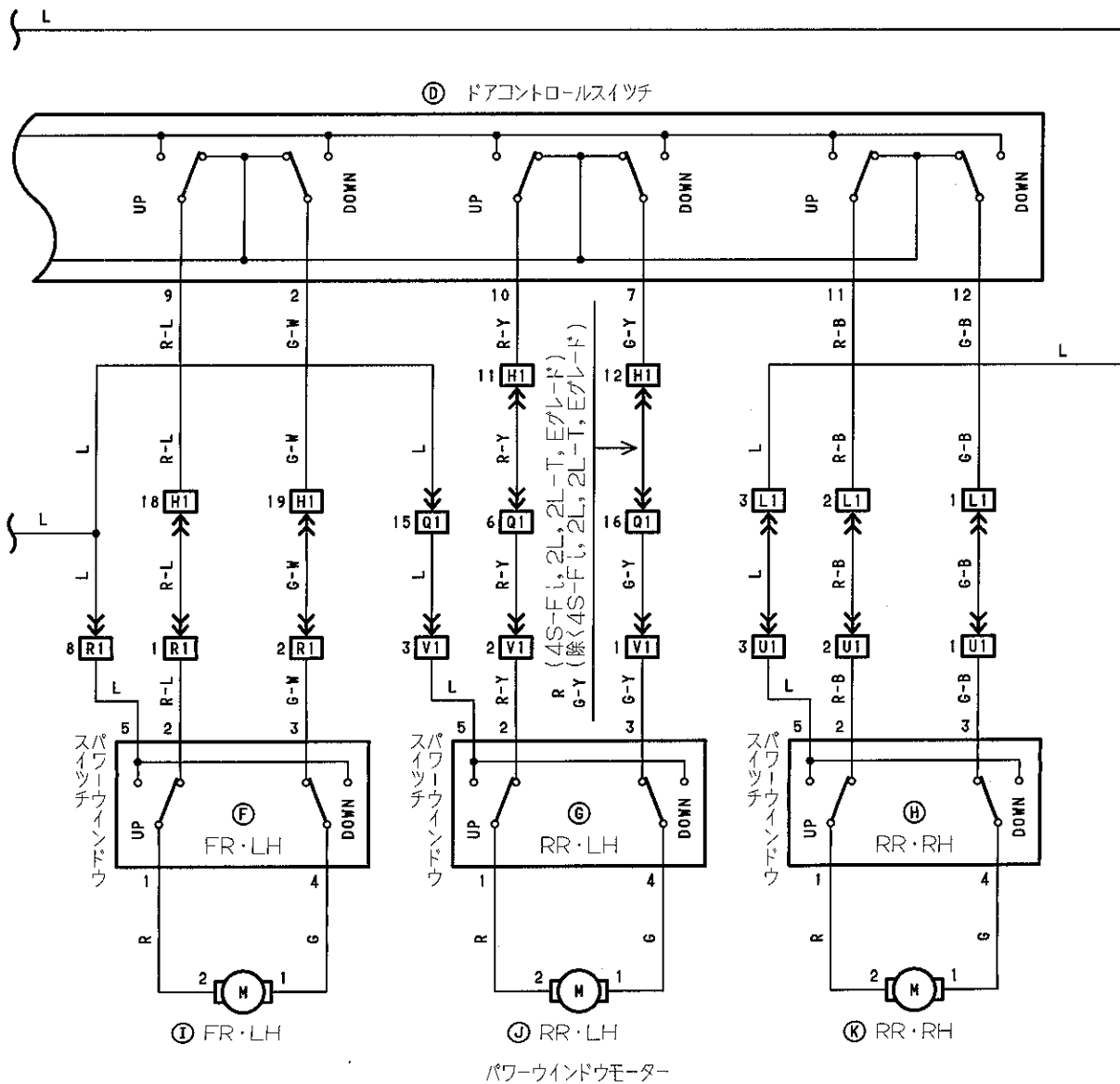



# パワーウィンドウ

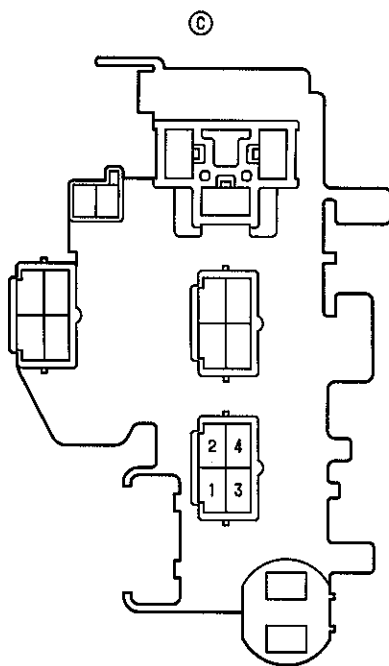
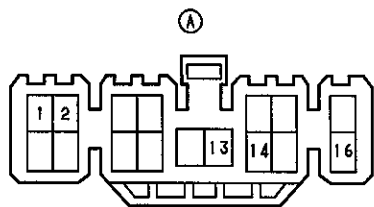

(J/B NO.1 カセット)

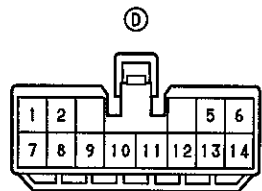

(E I J K)



(F G H)

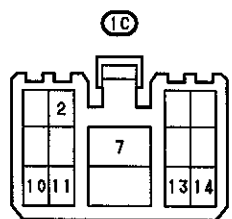
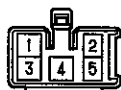

(IK)

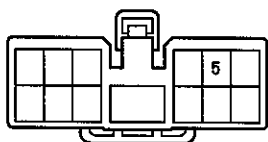

**H1** 青色

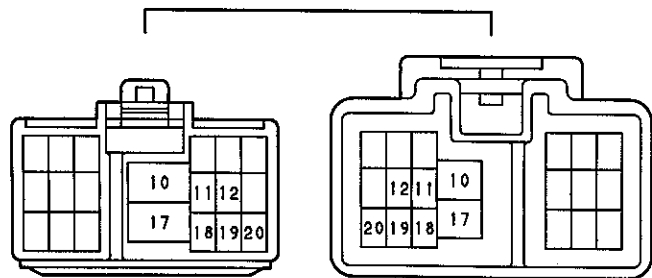

**L1** 青色

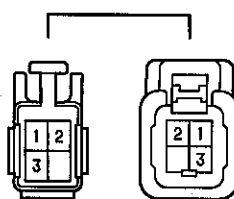

Q1

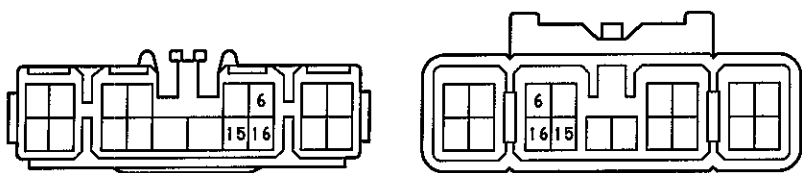

R1 青色

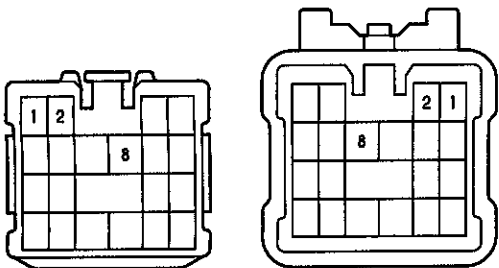

U1 V1 青色





# ドアロック

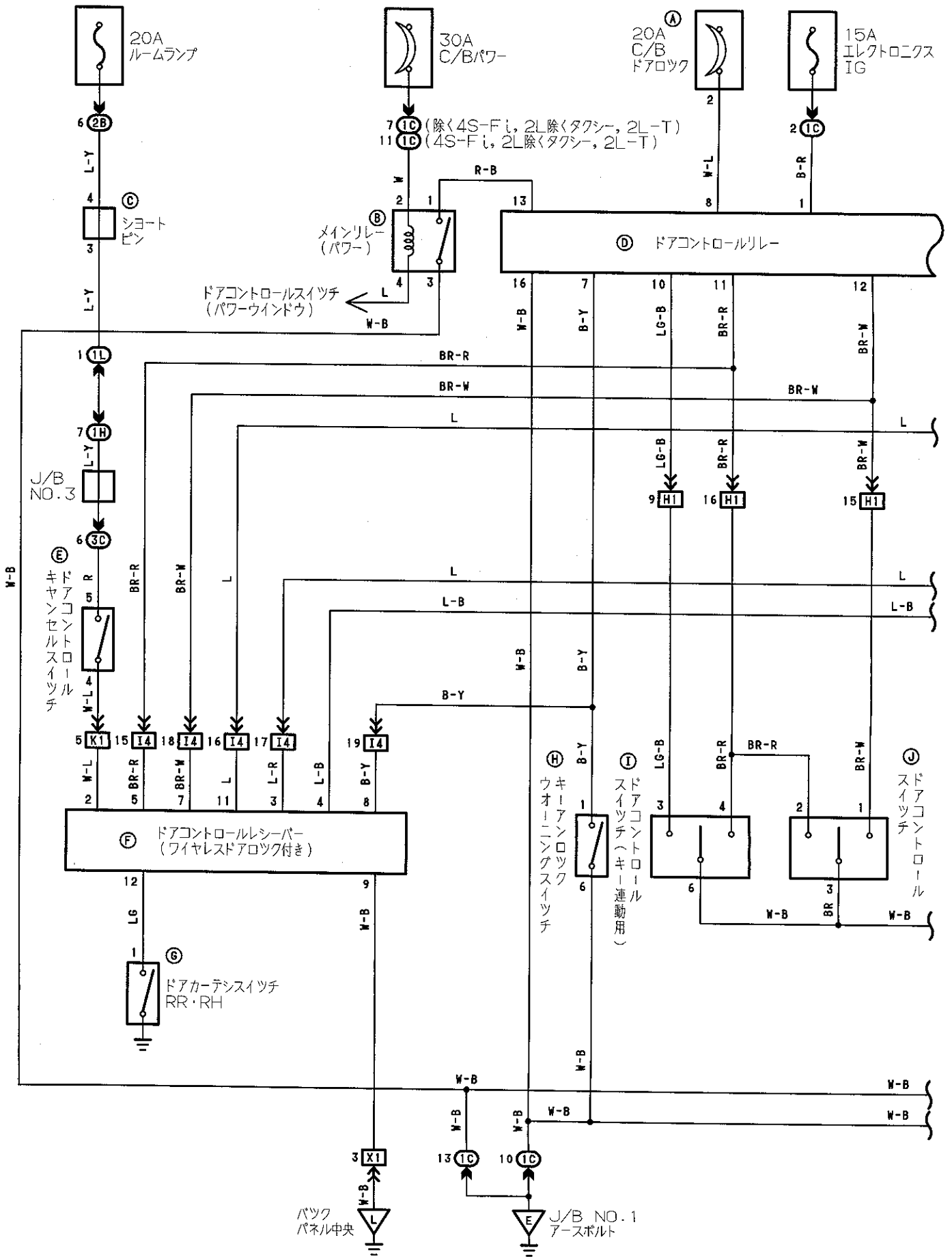

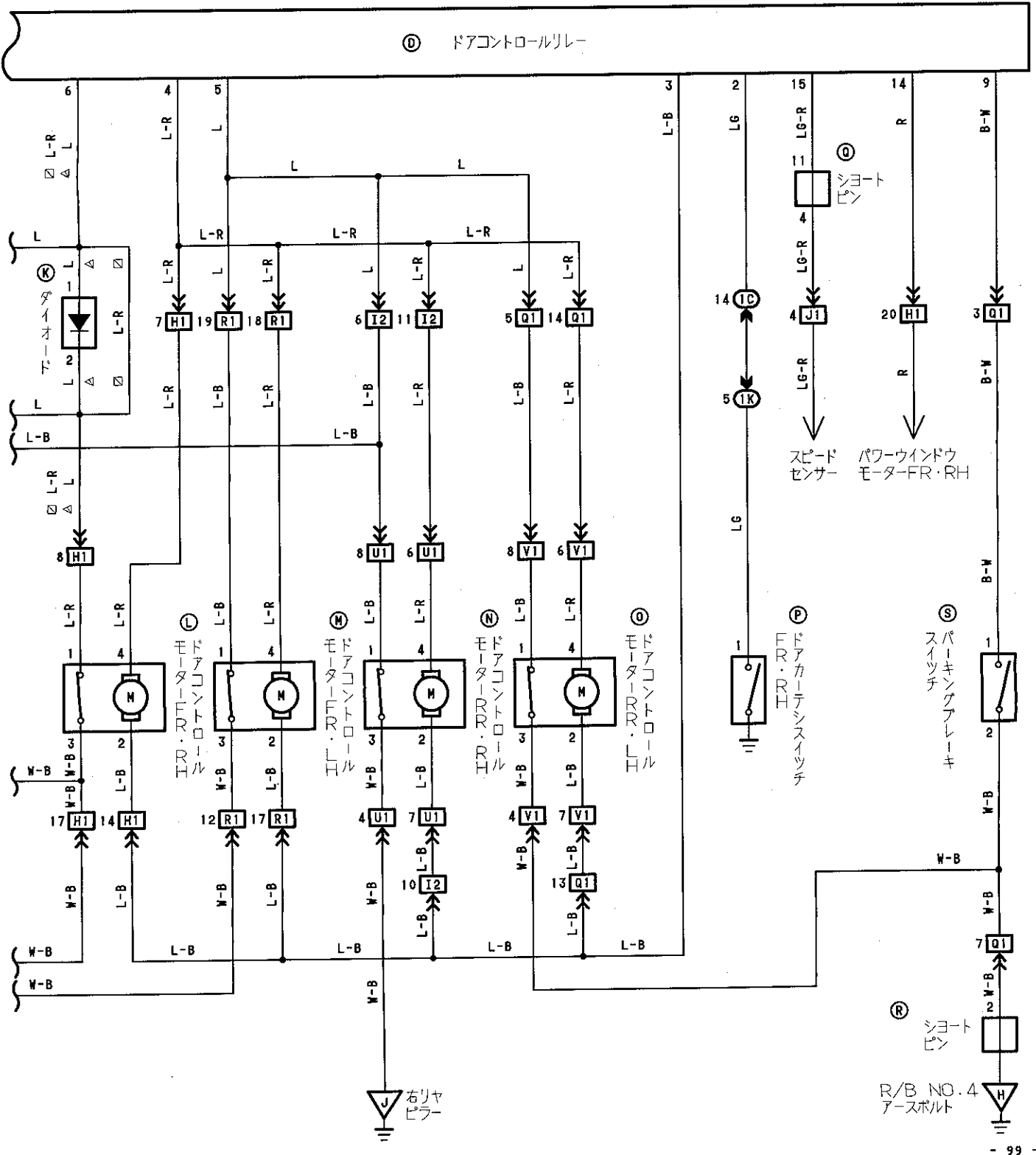



# ドアロック

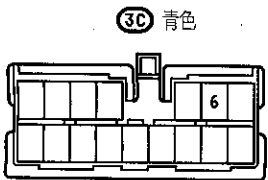
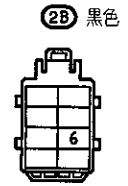
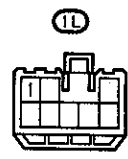
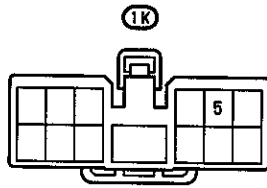
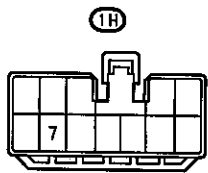
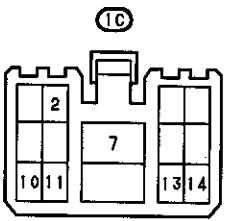
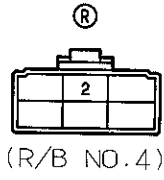
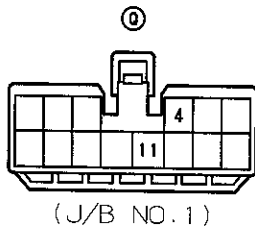
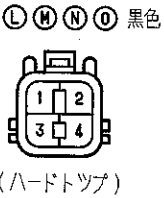
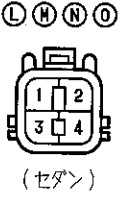
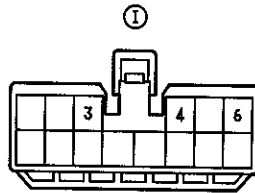
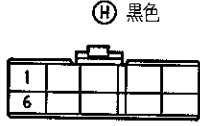
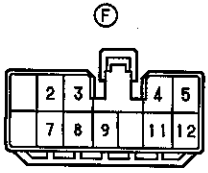
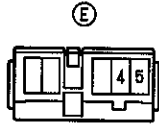
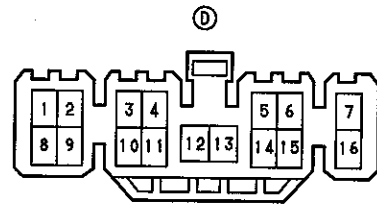
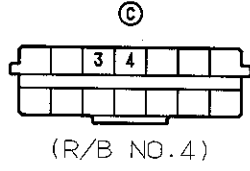
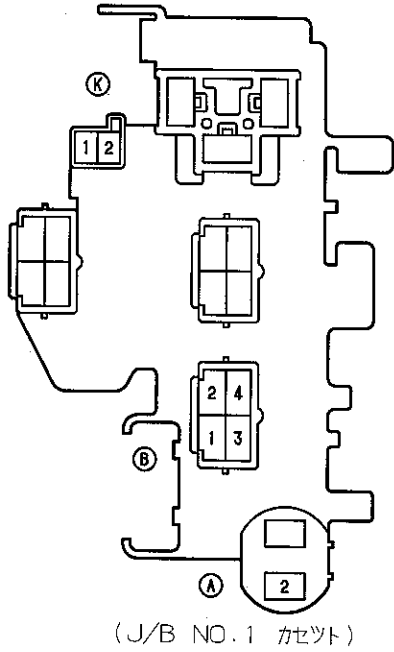

H1 青色

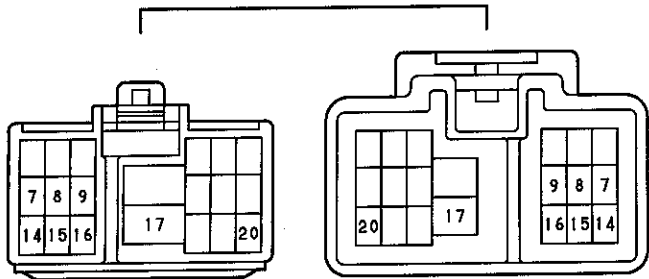

I2

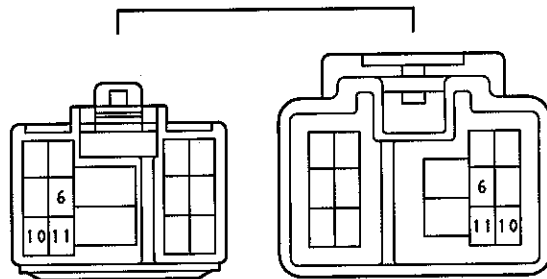

I4 濃灰色

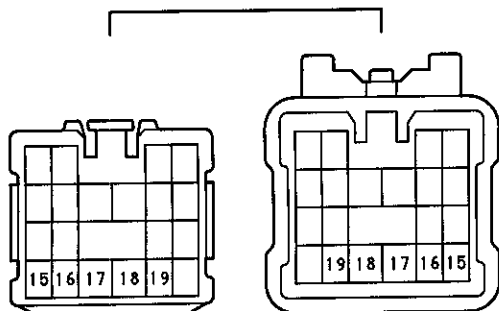

J1

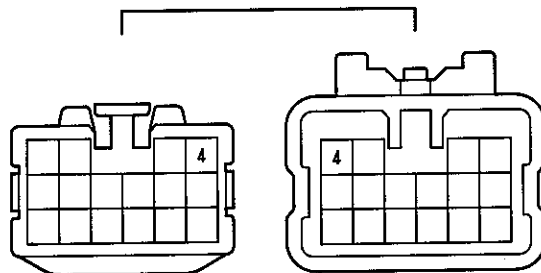

K1 だいたい色

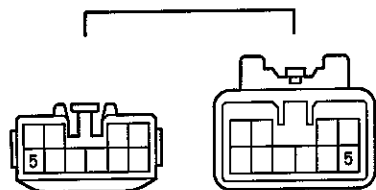

Q1

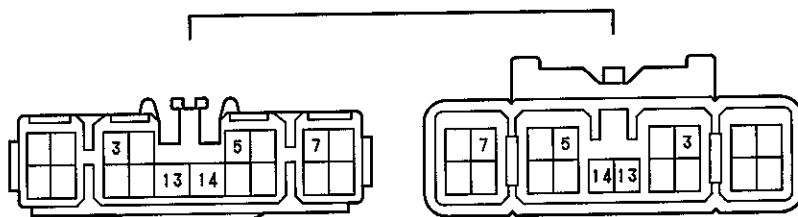

R1 青色

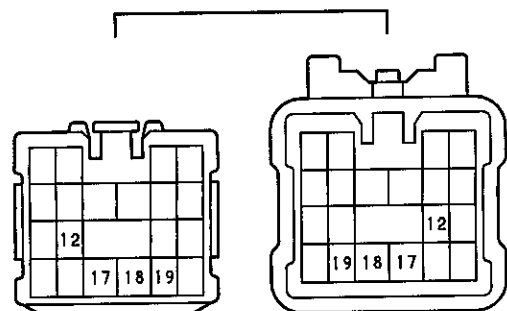

U1 V1 青色

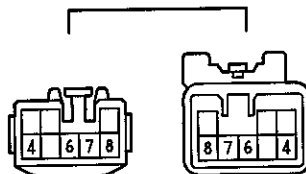

X1 黒色

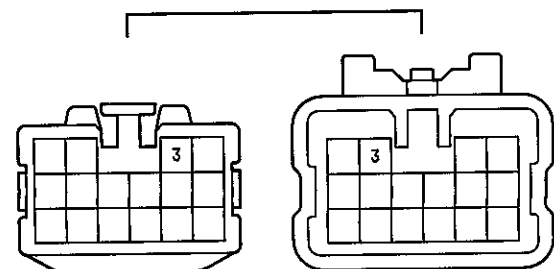

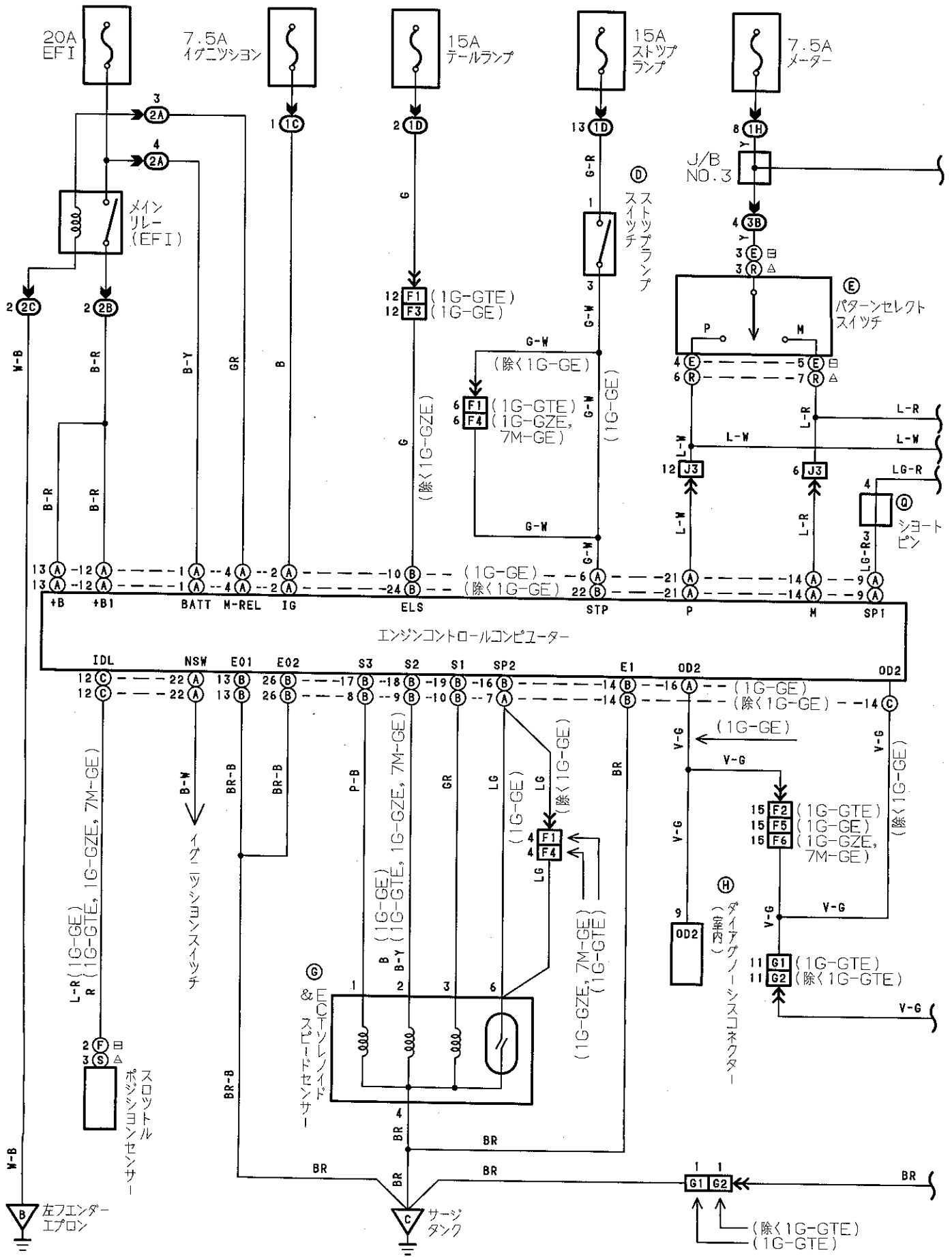

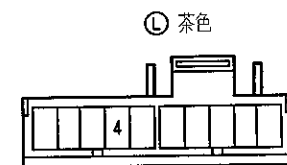
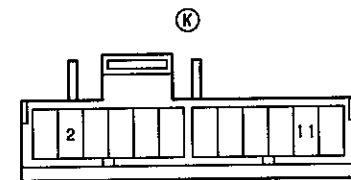
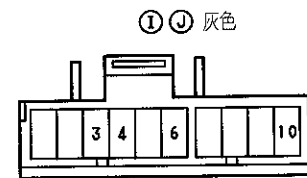
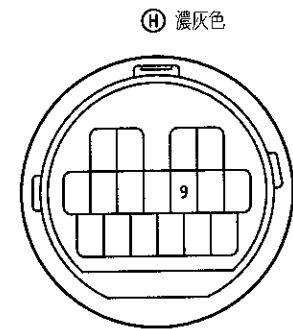
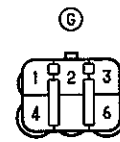
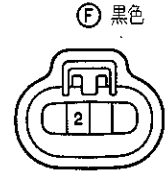
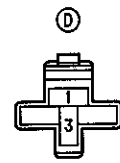
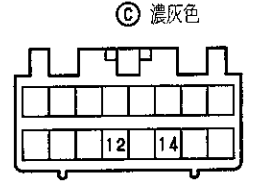
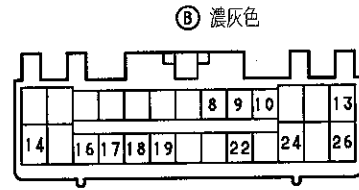
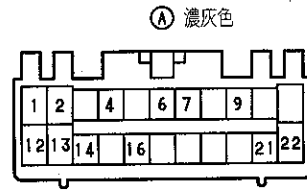
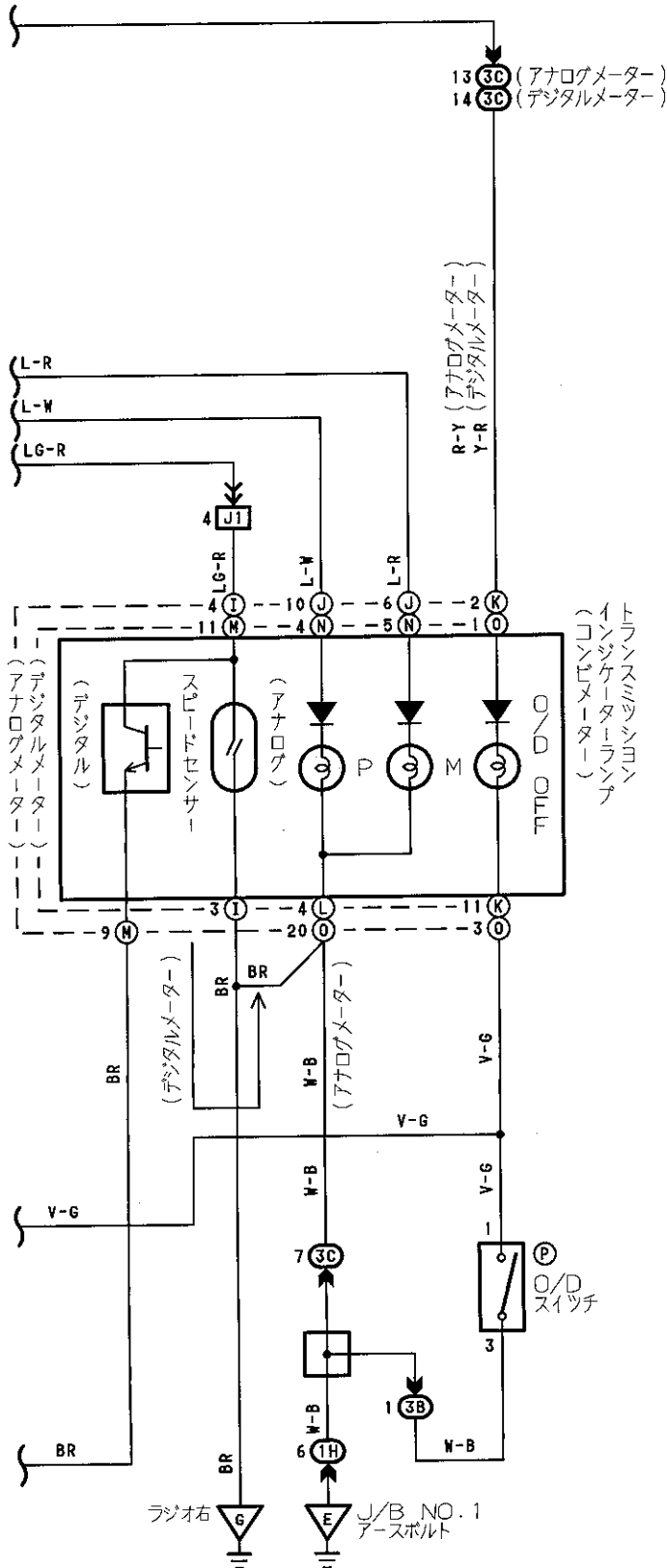

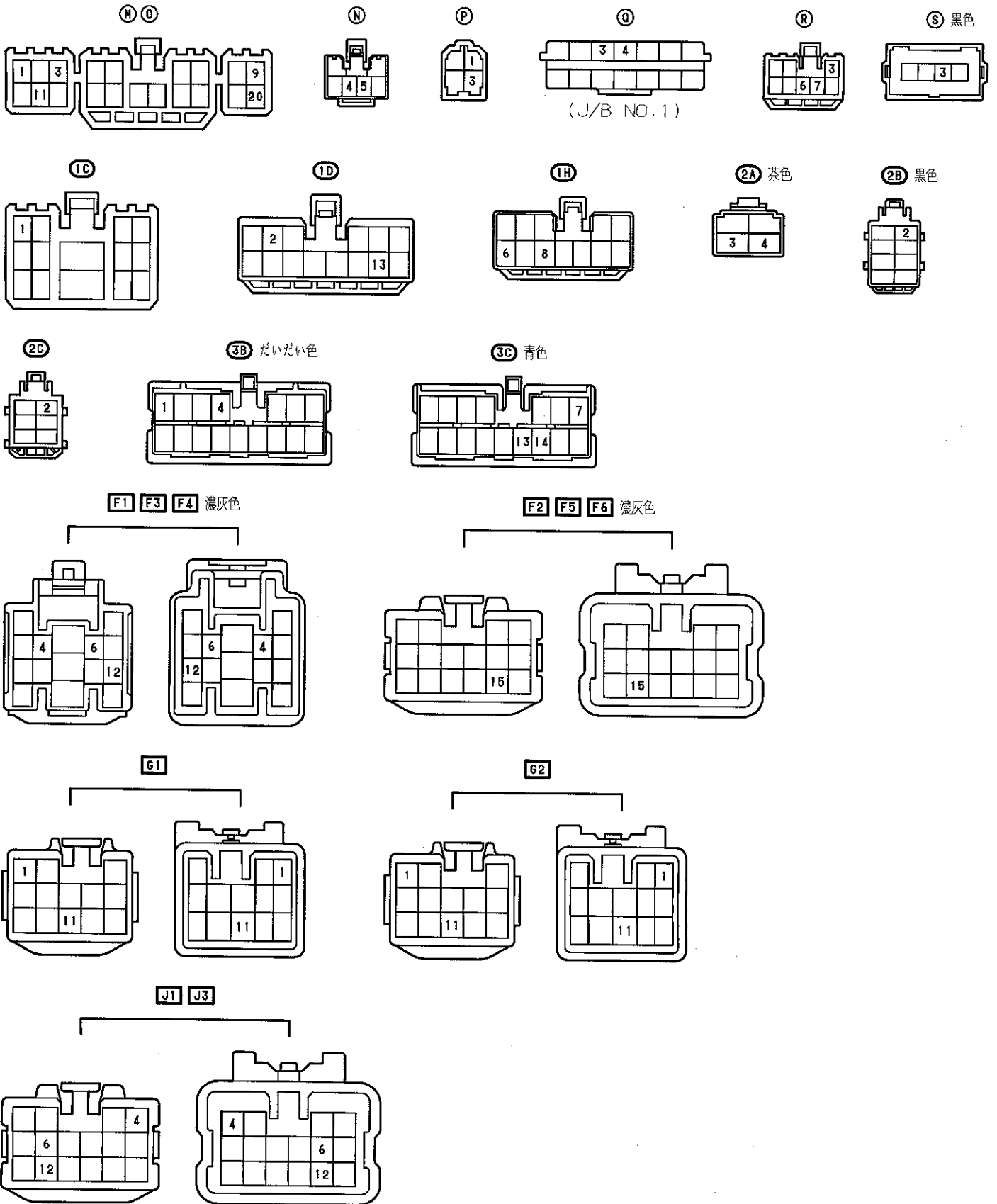

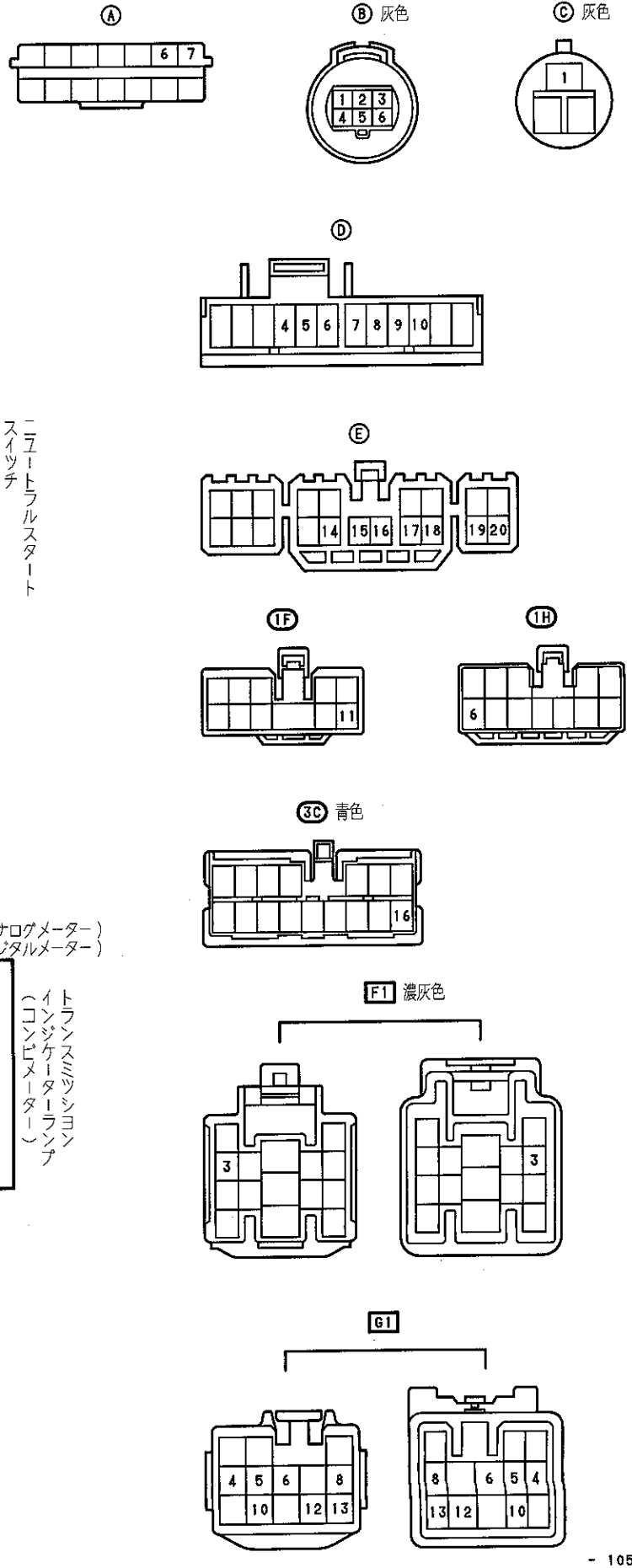
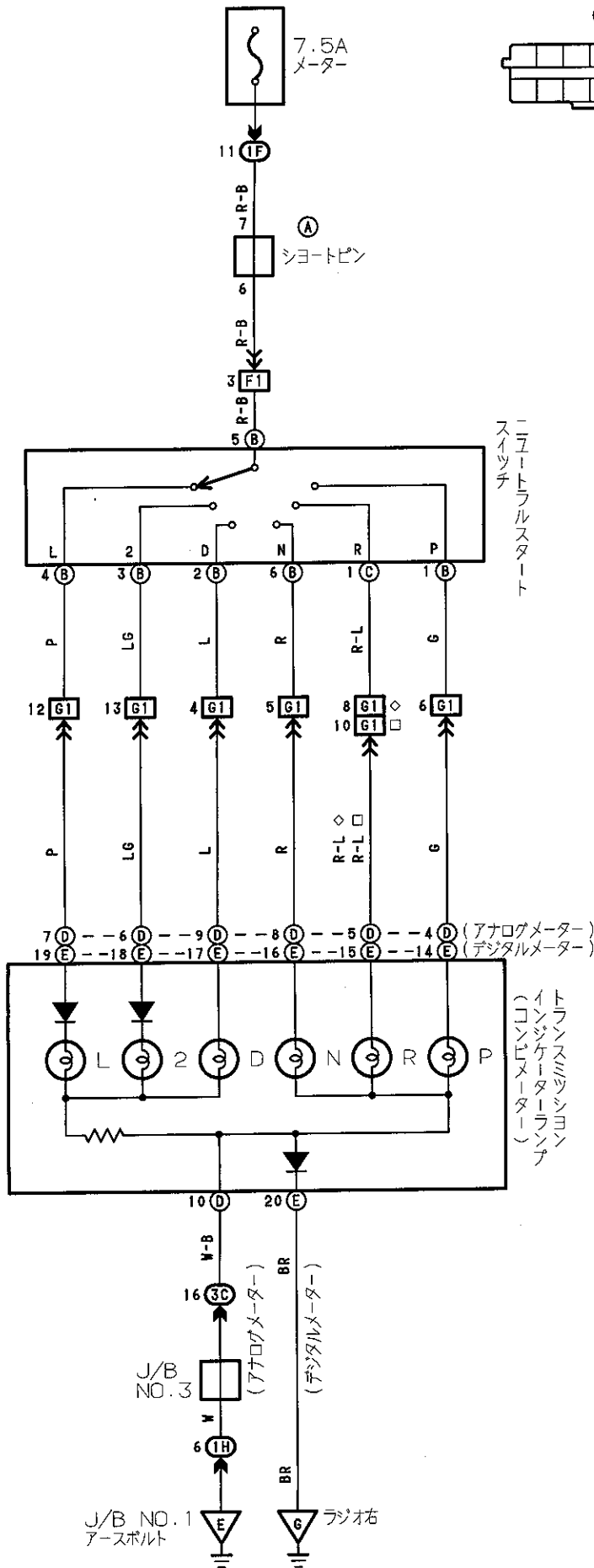



F1 濃灰色

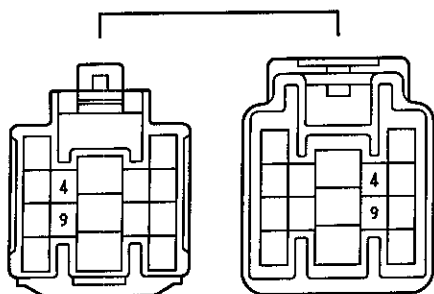

F3 濃灰色

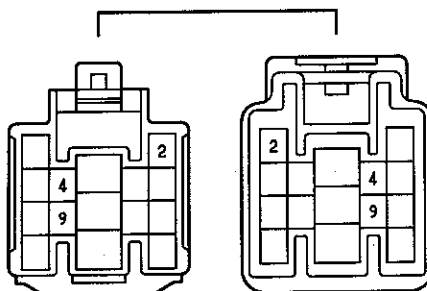

J3

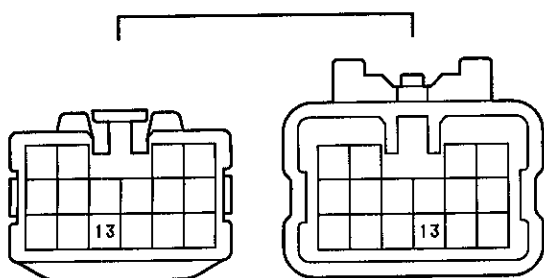



# パワーステアリング

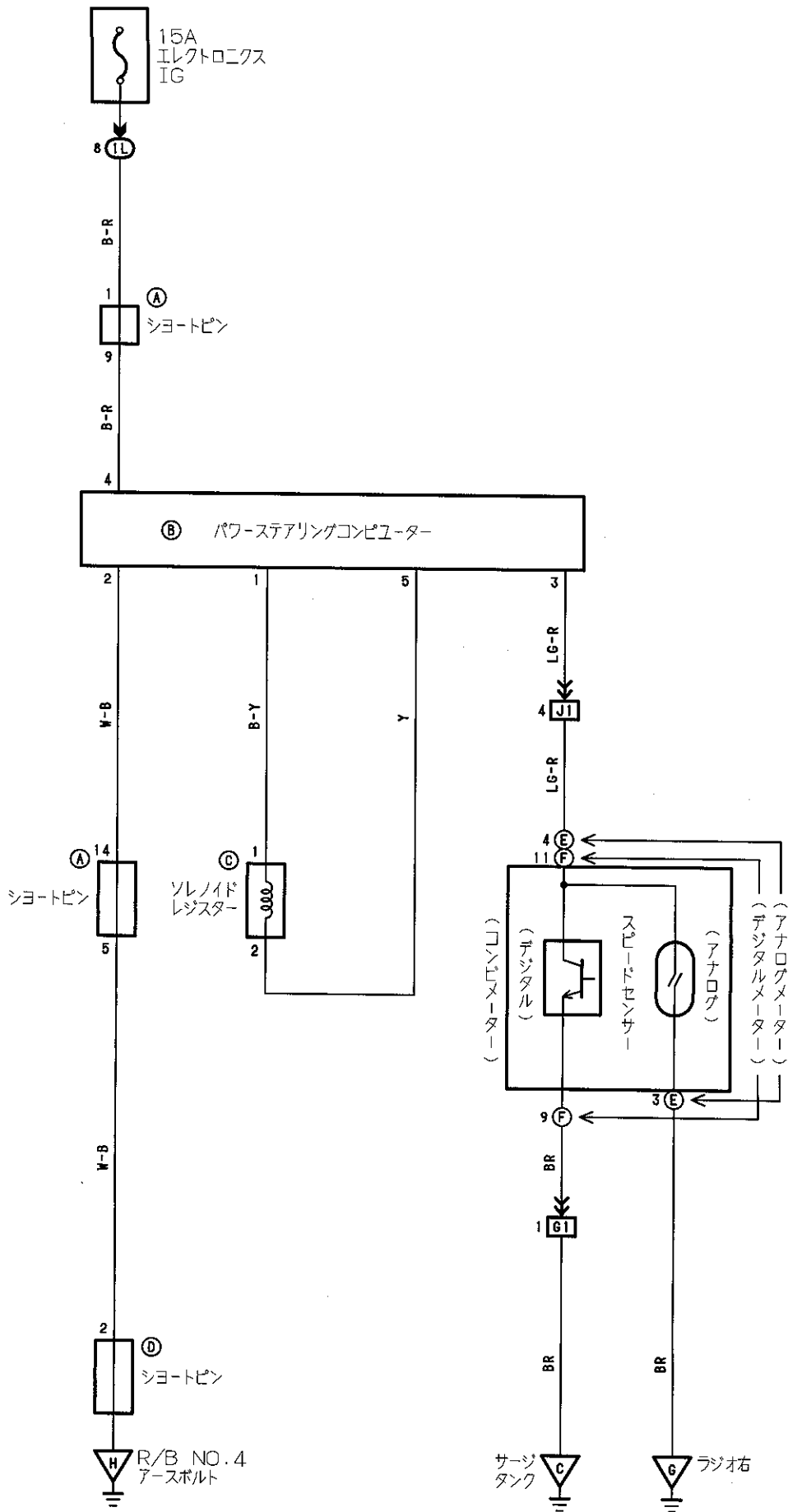

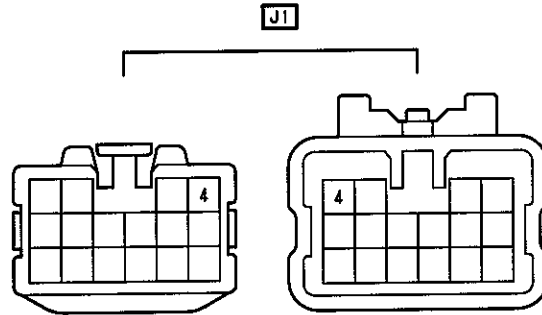
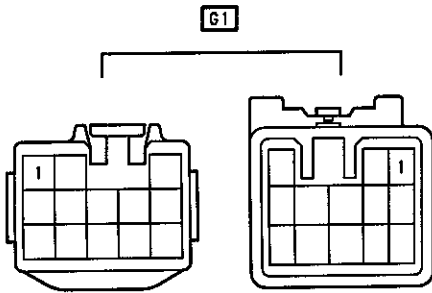
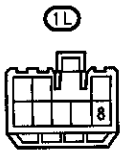
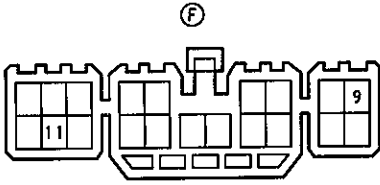
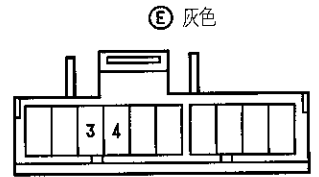
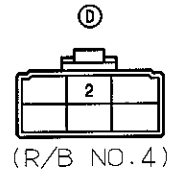
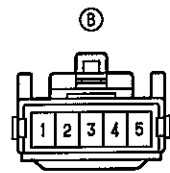
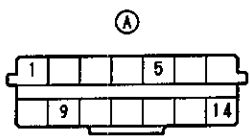

# ESC (トラクションコントロールなし)

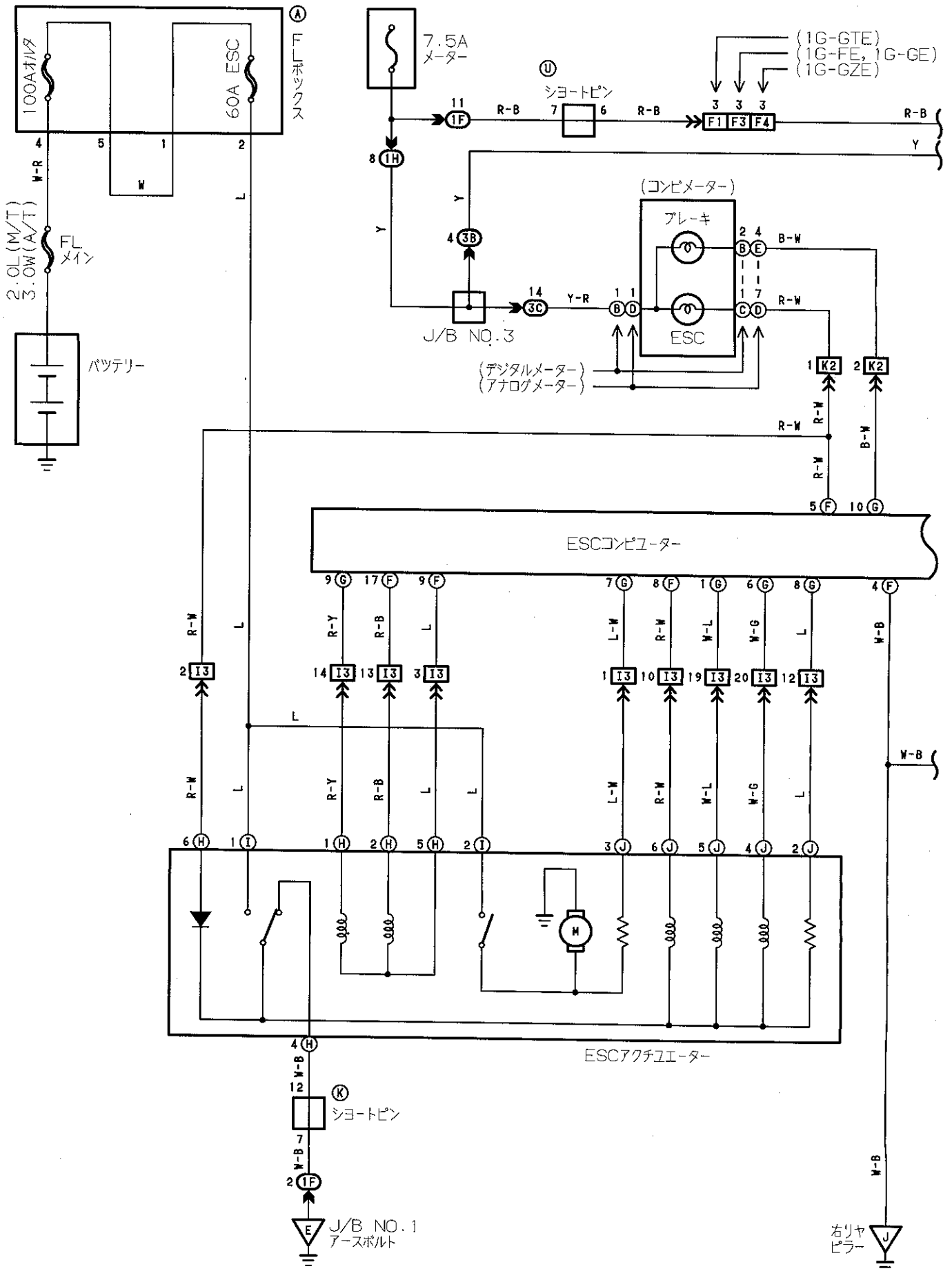

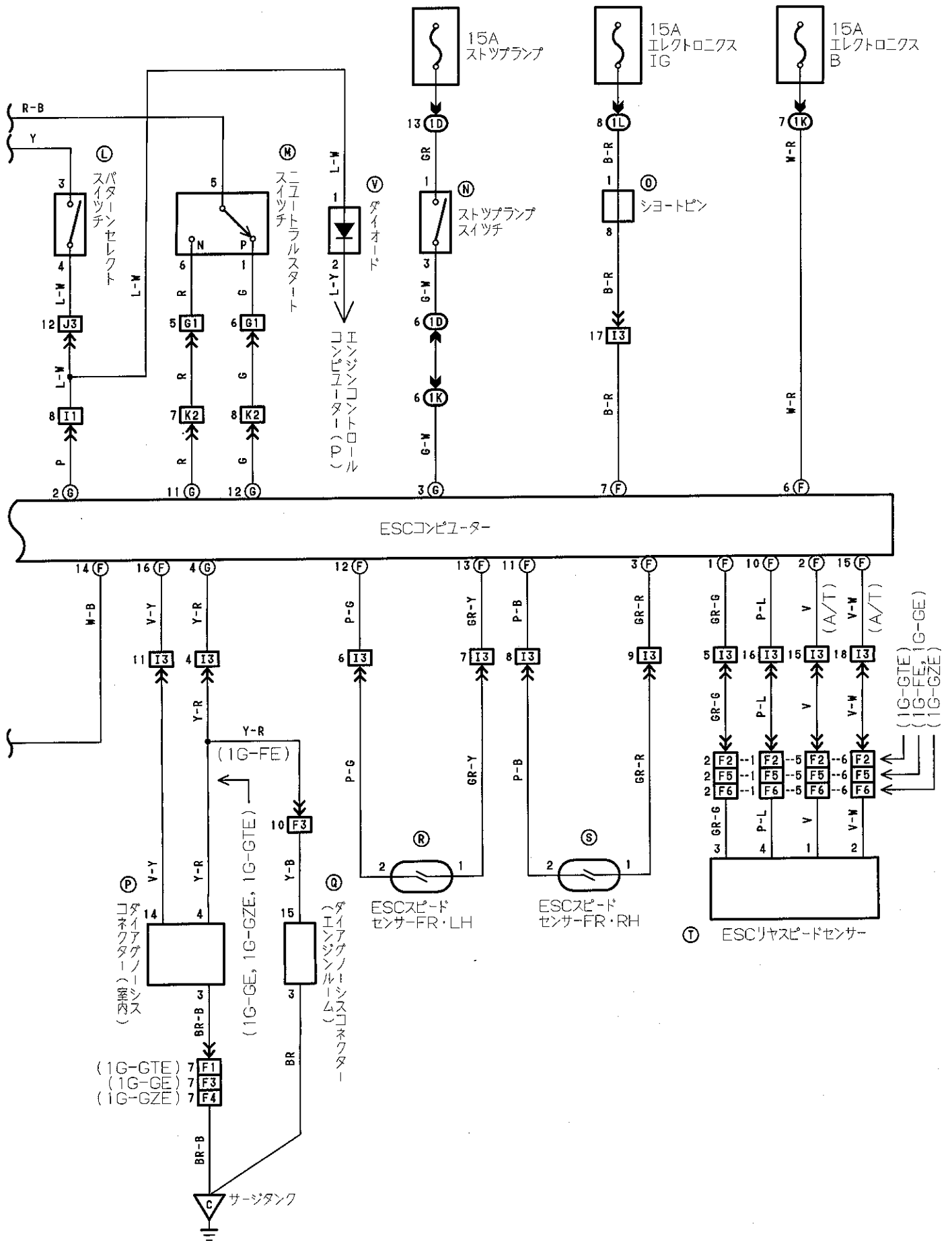

ESC (トラクションコントロールなし)

Ⓐ 黒色

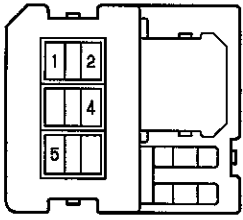

Ⓑ 茶色

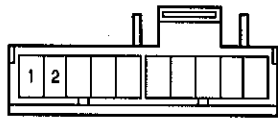

Ⓒ

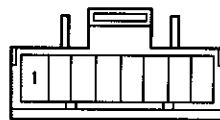

Ⓓ 灰色

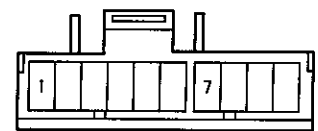

Ⓔ 青色

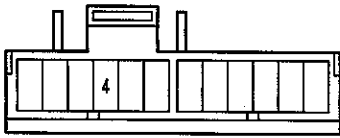

Ⓕ

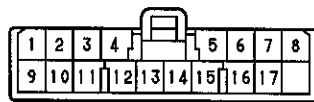

Ⓖ

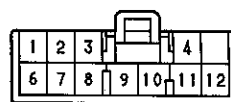

Ⓗ 黒色

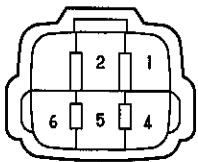

Ⓘ



Ⓙ 灰色

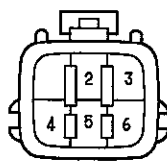

Ⓚ

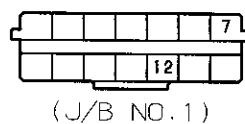

(J/B NO.1)

Ⓛ



Ⓜ 灰色



Ⓝ



Ⓞ

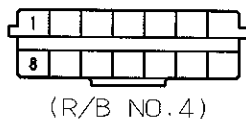

(R/B NO.4)

Ⓟ 濃灰色

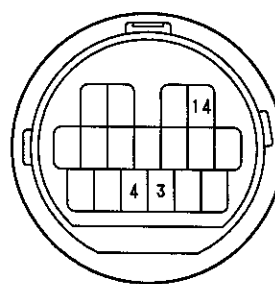

Ⓠ 濃灰色

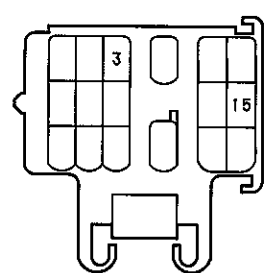

Ⓡ Ⓢ 灰色



Ⓣ 灰色



Ⓤ

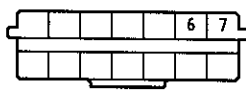

Ⓡ 黒色



ⓉⓁ

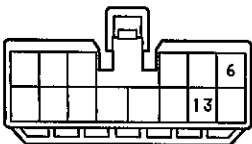

ⓉⓍ

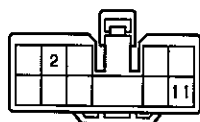

ⓉⓎ

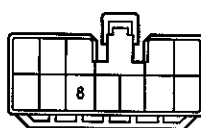

ⓉⓀ

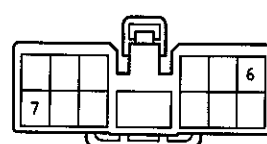

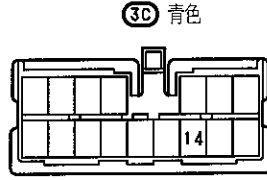
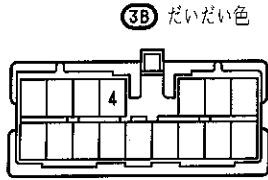
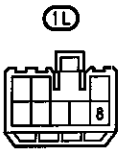

F1 F3 F4 濃灰色

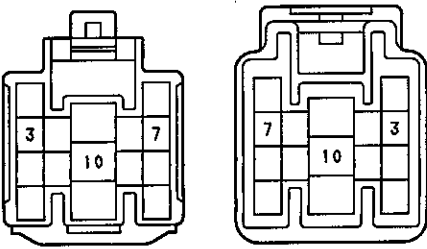

F2 F5 F6 濃灰色

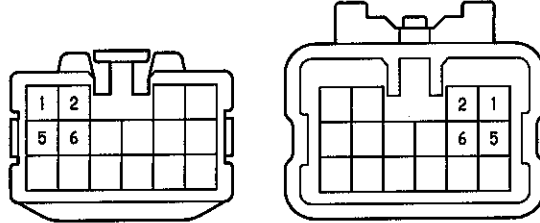

G1

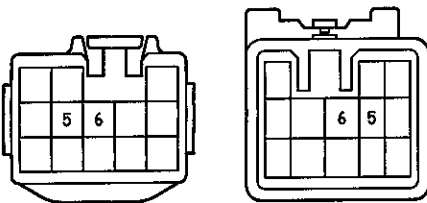

I1 濃灰色

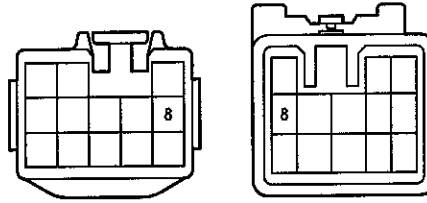

I3

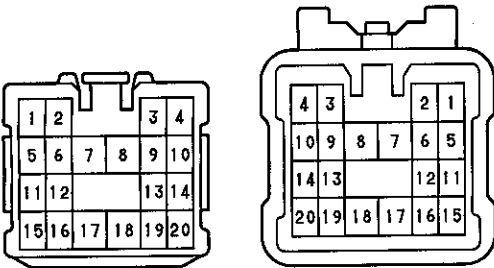

J3

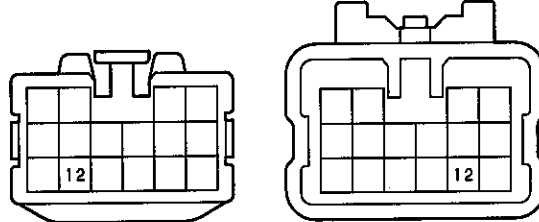

K2

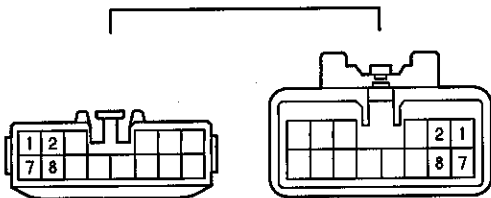

# ESC (トラクションコントロール付き)

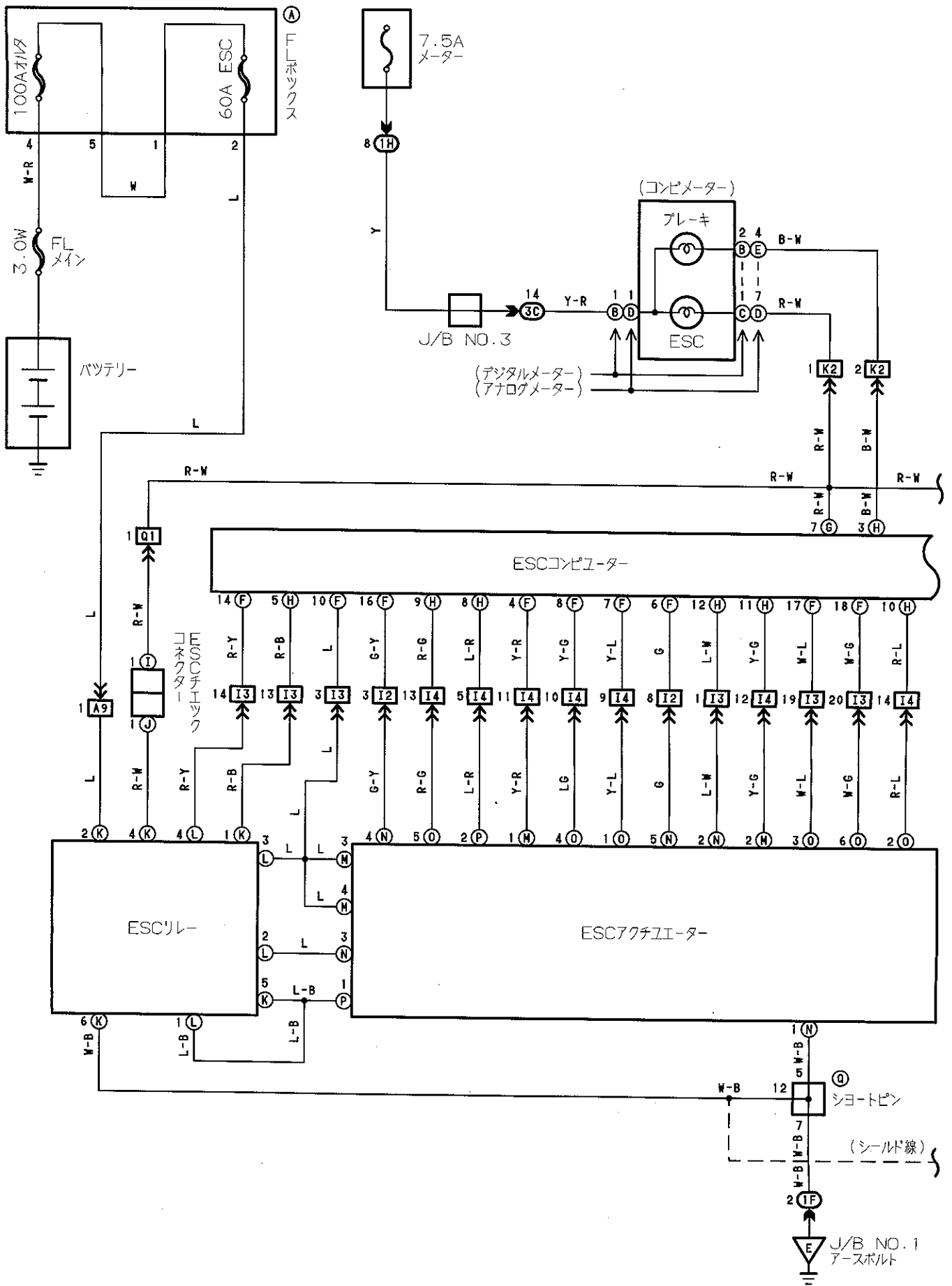

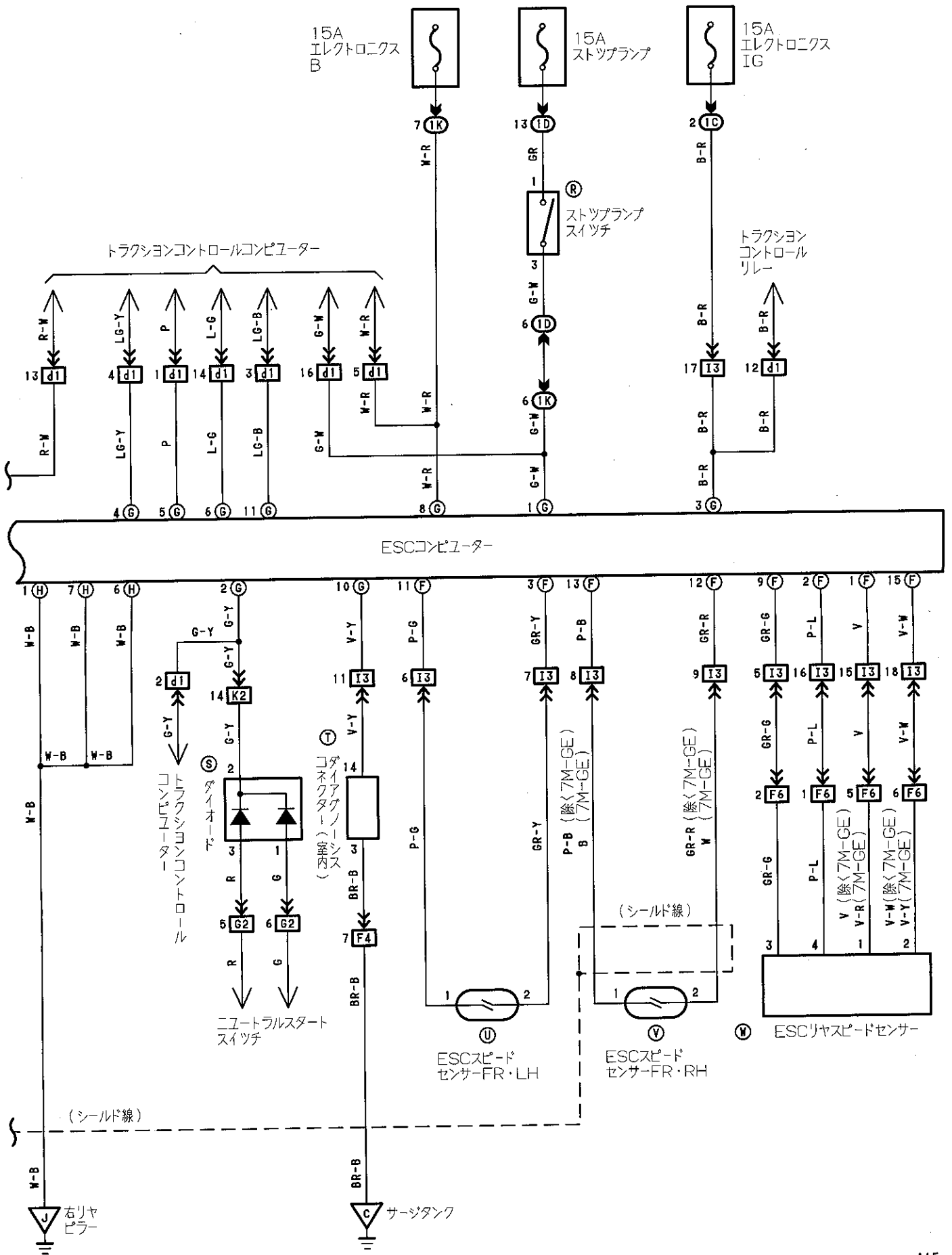

# ESC (トラクションコントロール付き)

Ⓐ 黒色

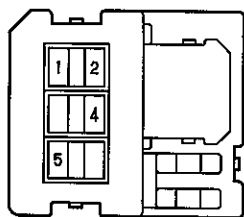

Ⓑ 茶色

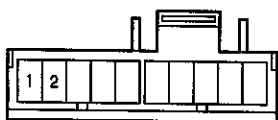

Ⓒ

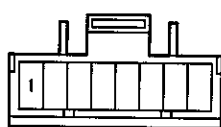

Ⓓ 灰色

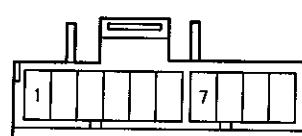

Ⓔ 青色

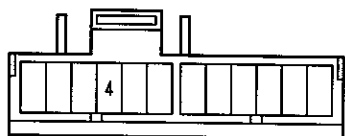

Ⓕ

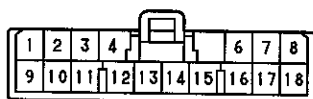

Ⓖ

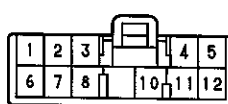

Ⓖ

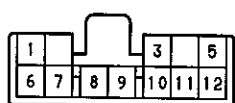

Ⓘ 灰色



Ⓙ 灰色



Ⓚ 灰色

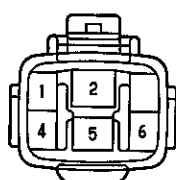

Ⓛ 灰色



Ⓜ 黒色



Ⓝ 黒色

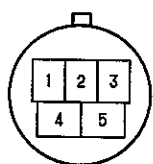

Ⓞ 黒色

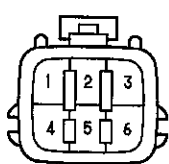

Ⓟ 黒色



Ⓠ

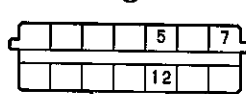

Ⓡ

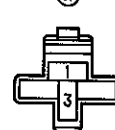

Ⓢ だいたい色

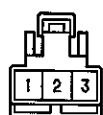

Ⓣ 濃灰色

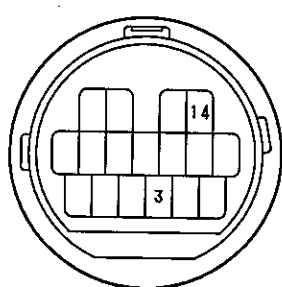

Ⓤ Ⓥ 灰色



Ⓦ 灰色



ⓉC

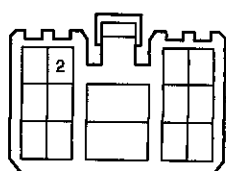

ⓉD

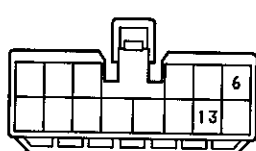

ⓉF

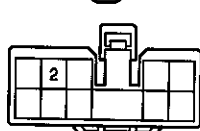

ⓉH

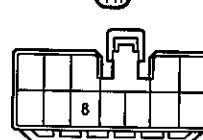

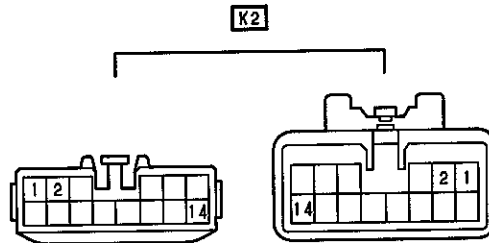
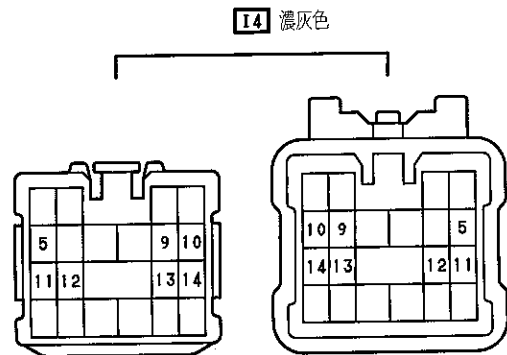
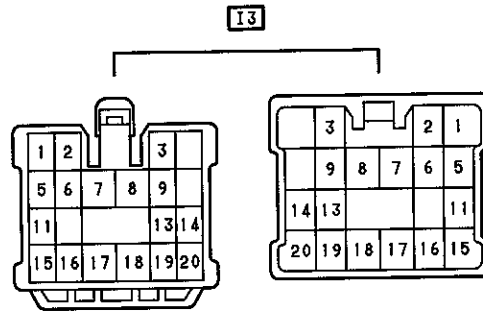
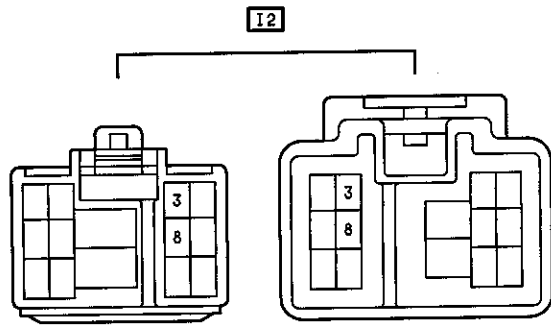
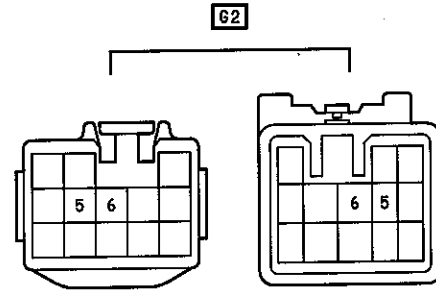
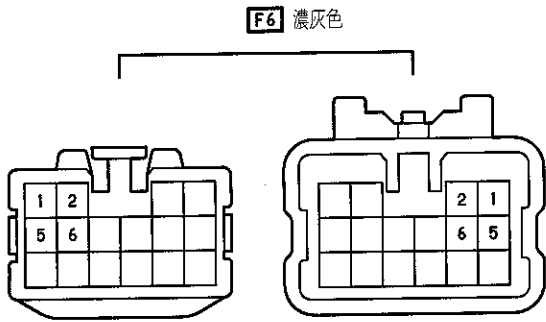
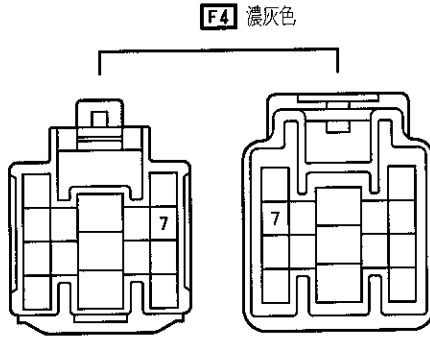
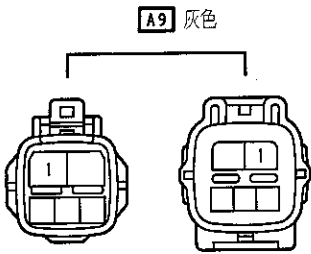
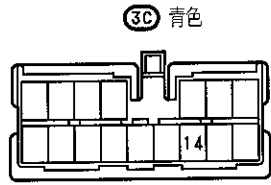
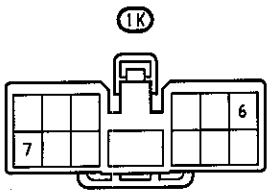

Q1

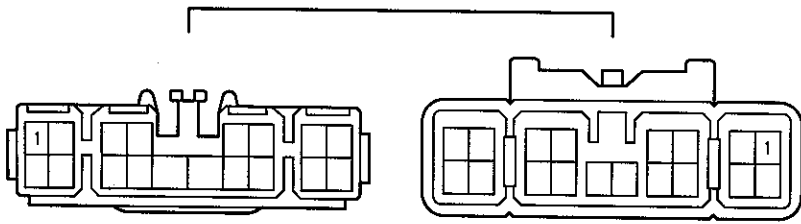

d1 黒色

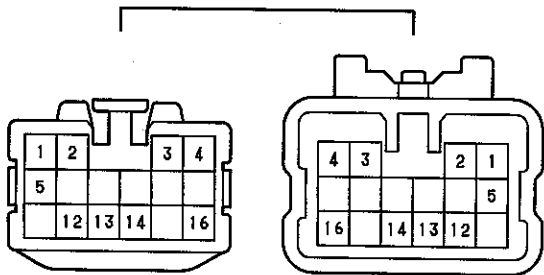

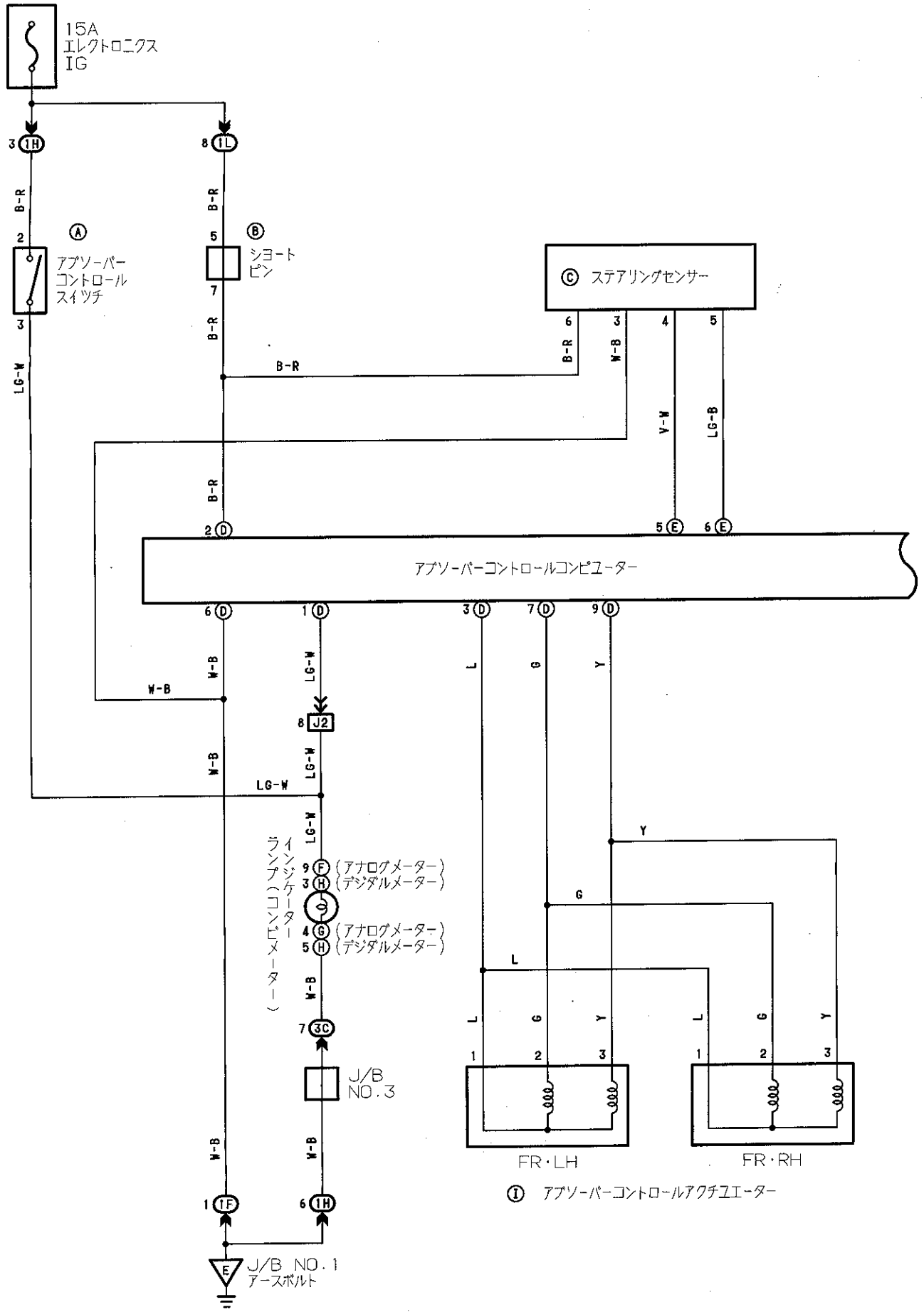

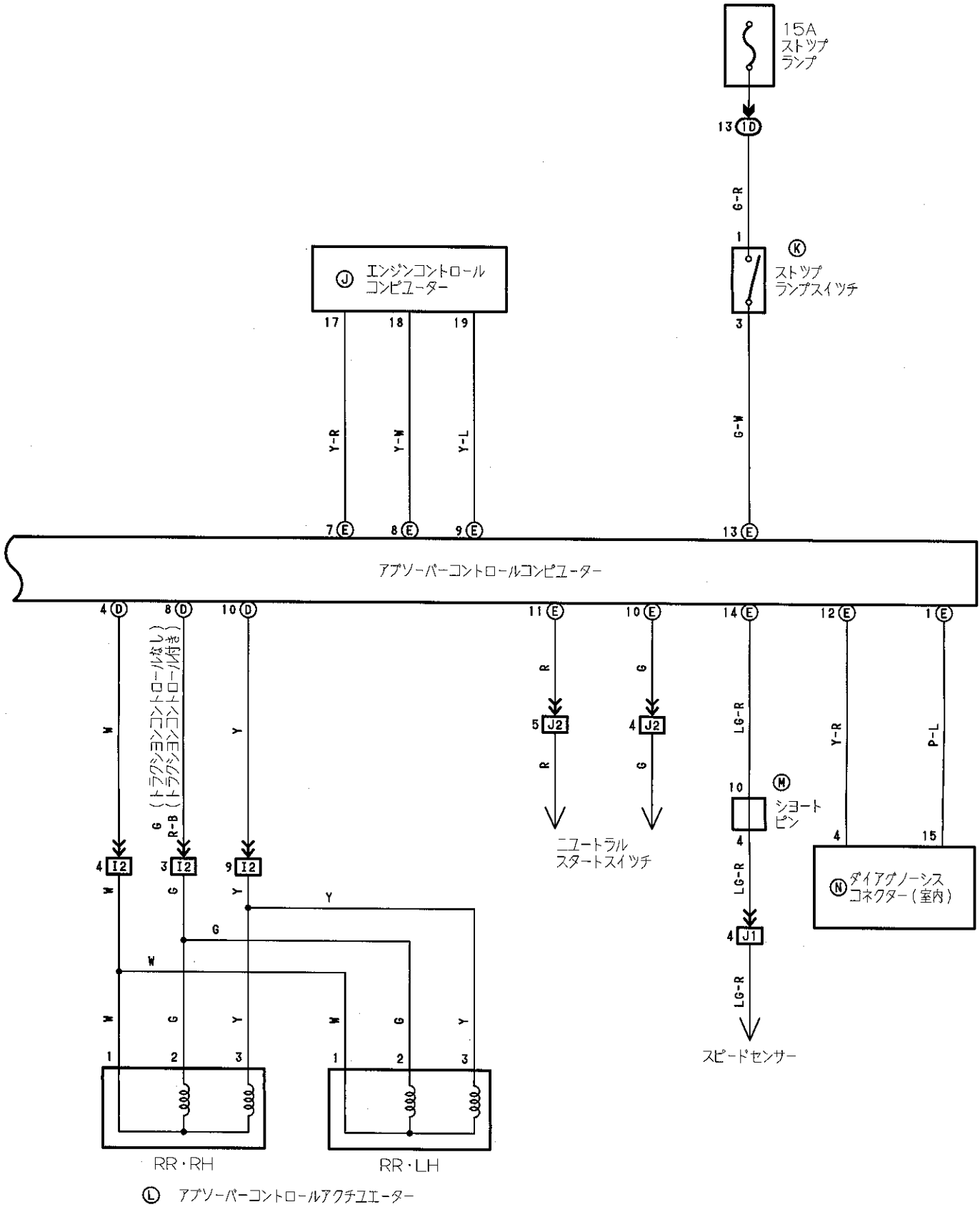

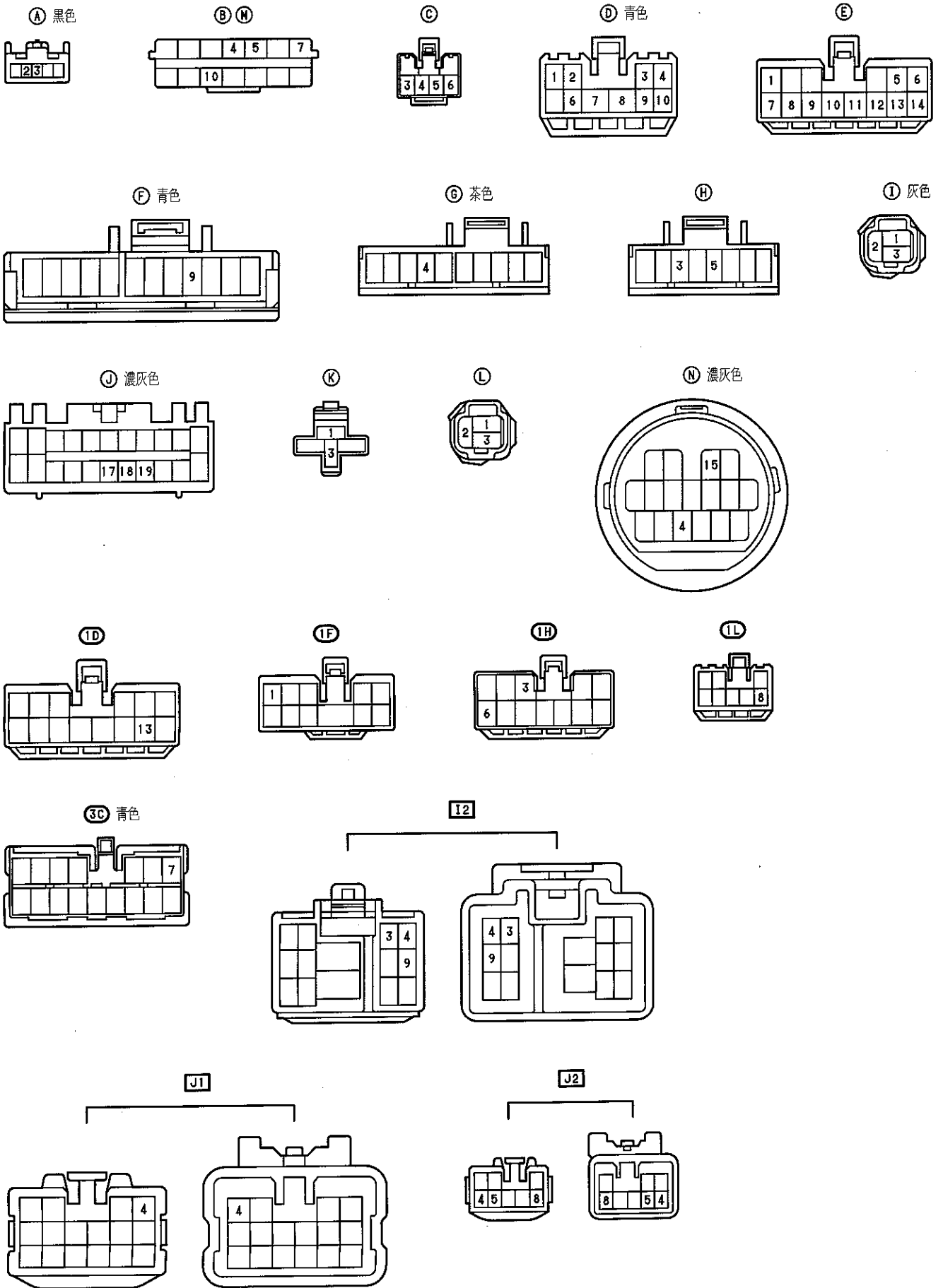

# TRC トラクションコントロール

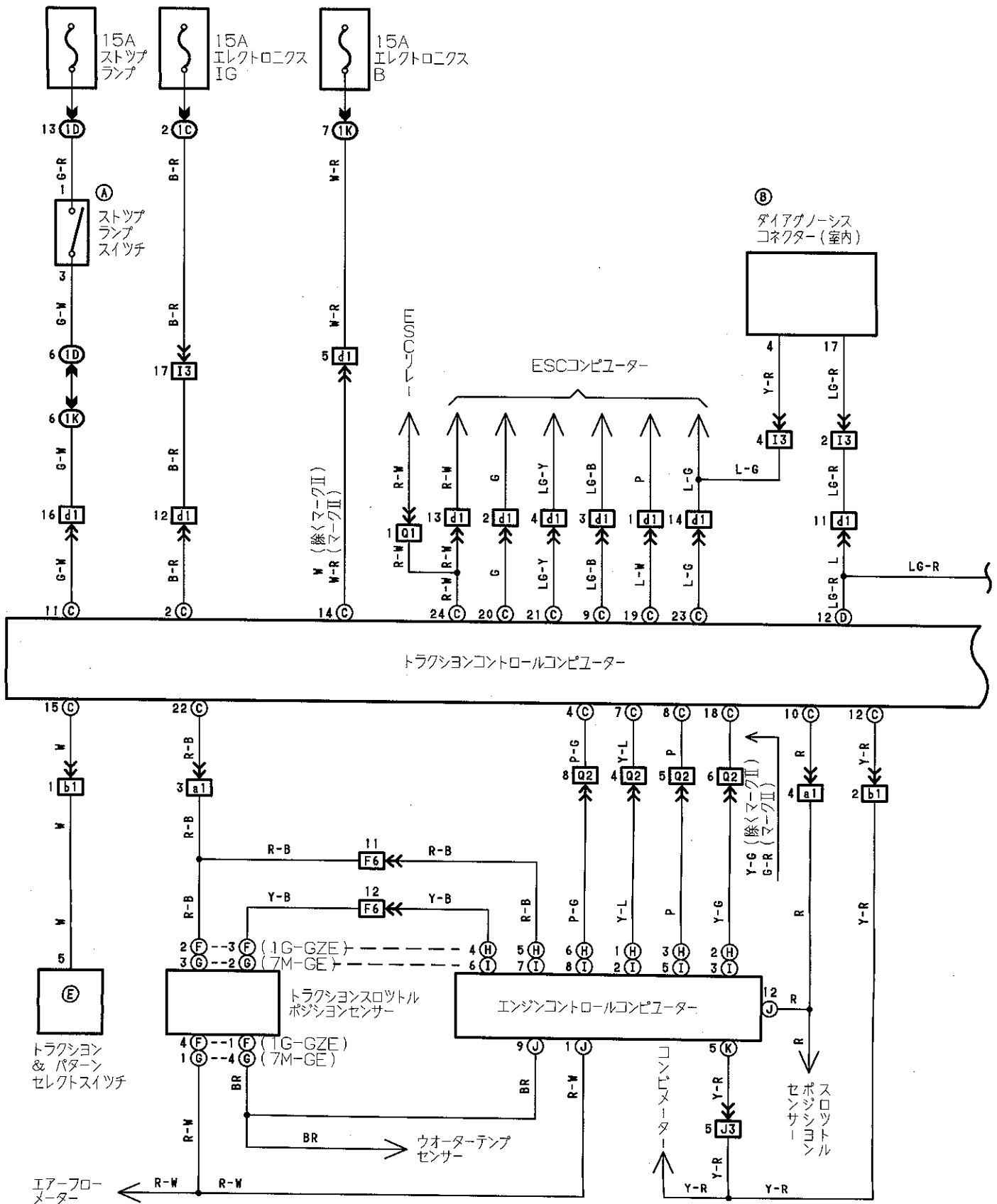

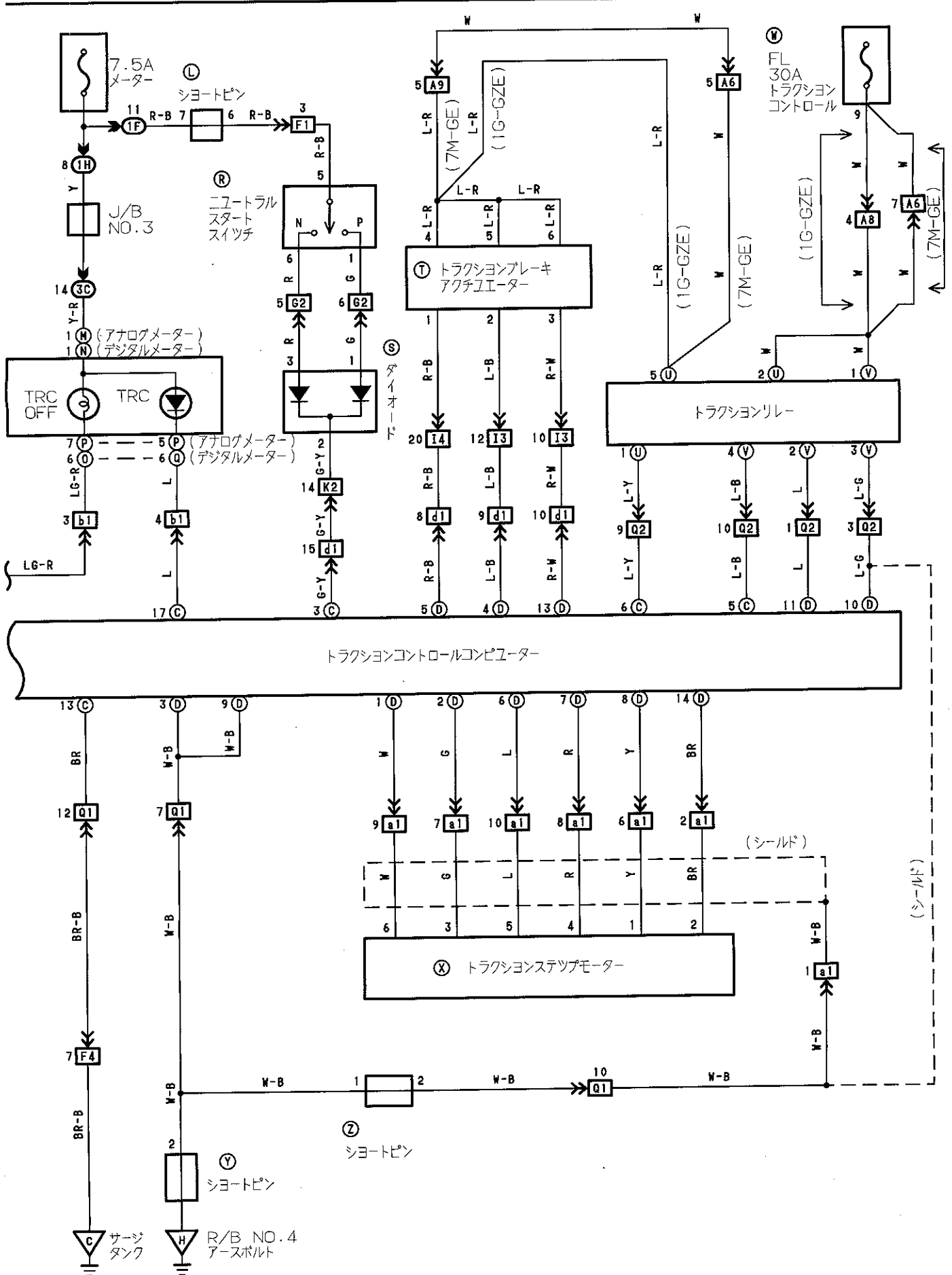

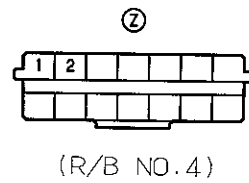
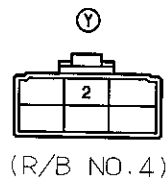
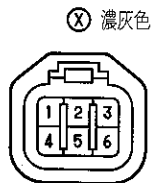
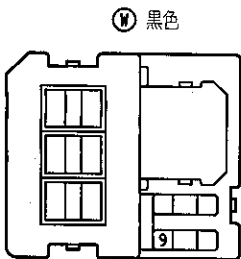
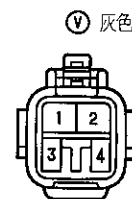
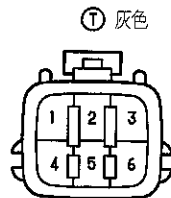
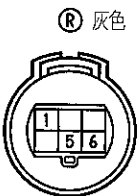
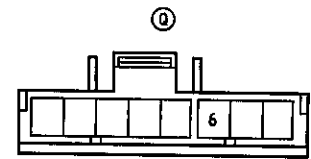
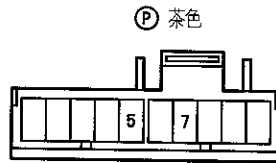
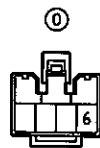
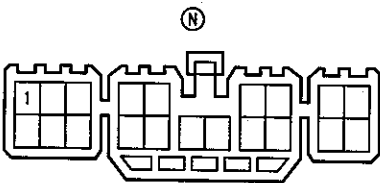
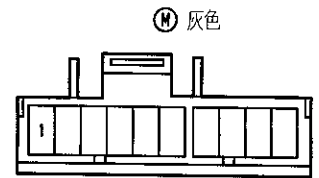
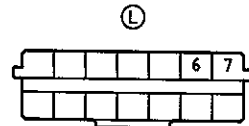
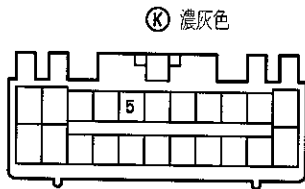
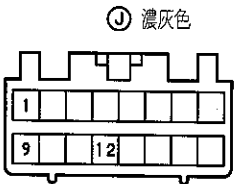
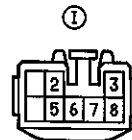
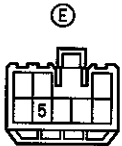
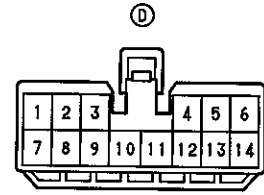
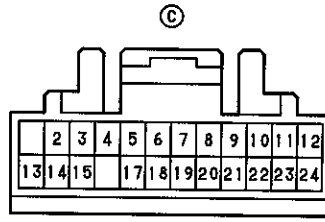
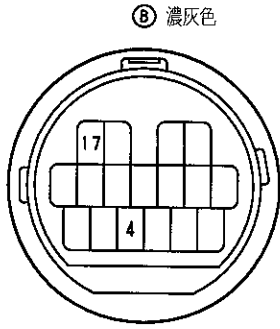

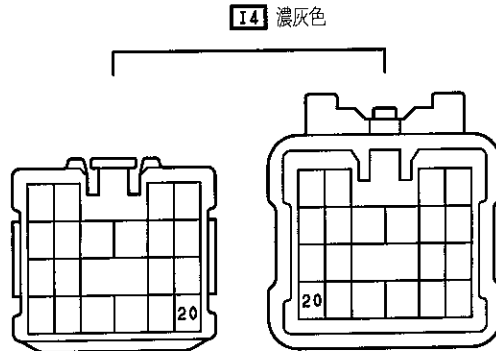
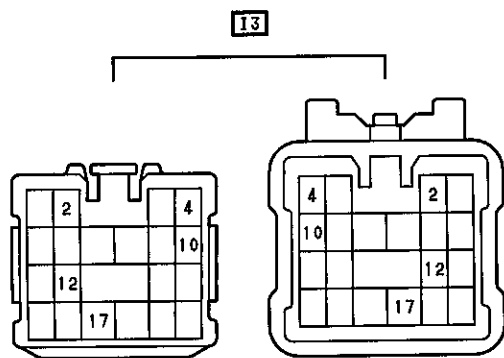
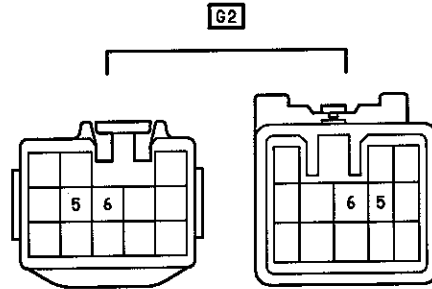
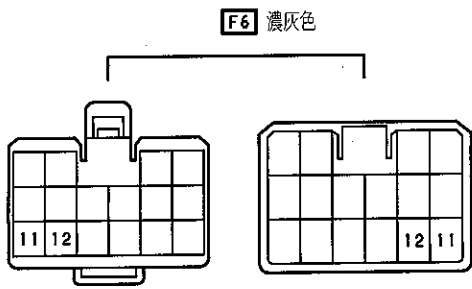
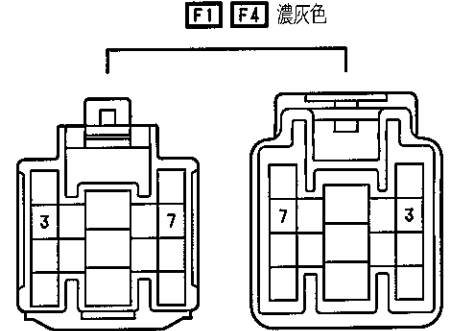
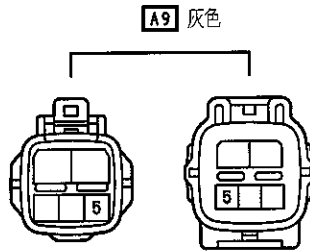
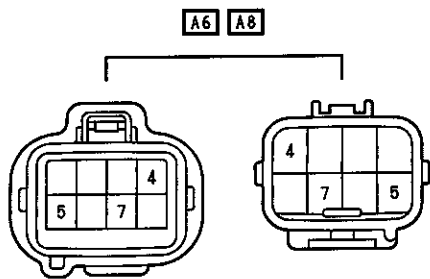
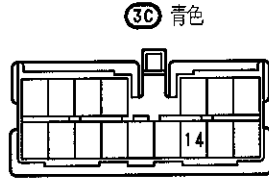
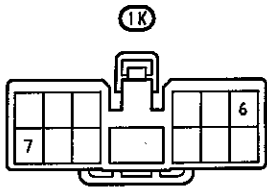
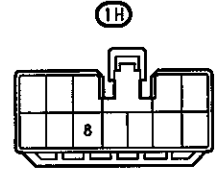
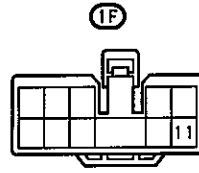
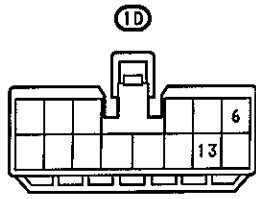
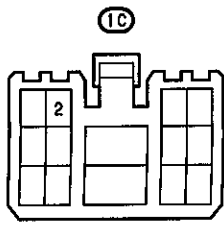

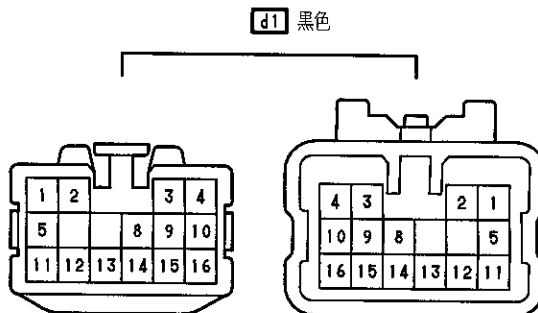
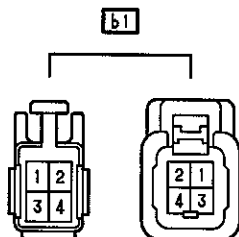
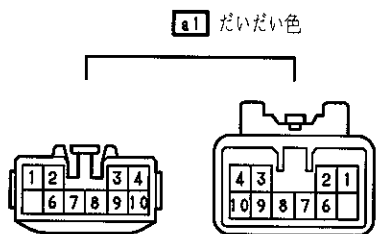
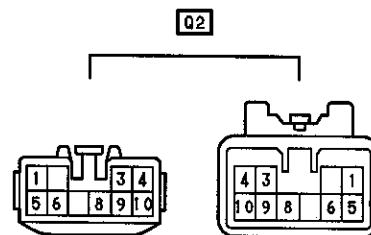
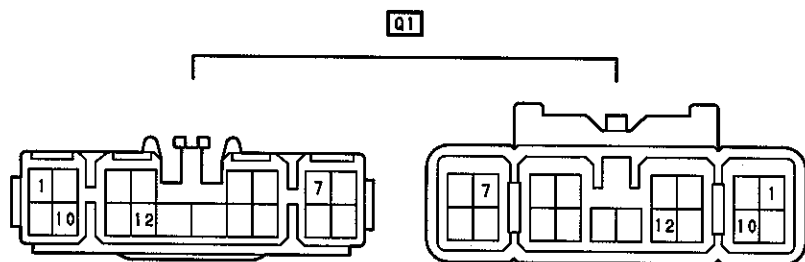
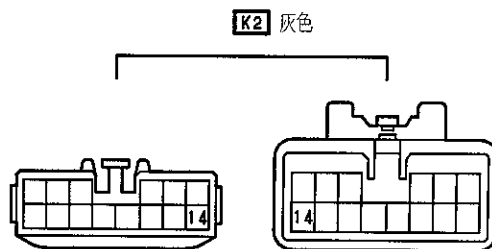
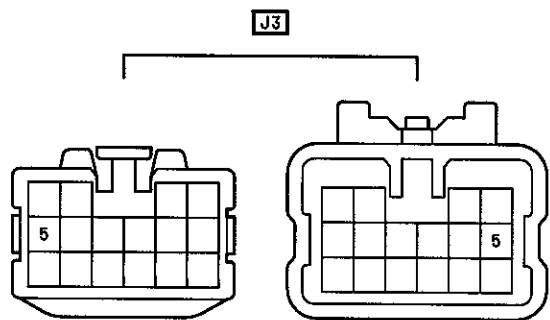

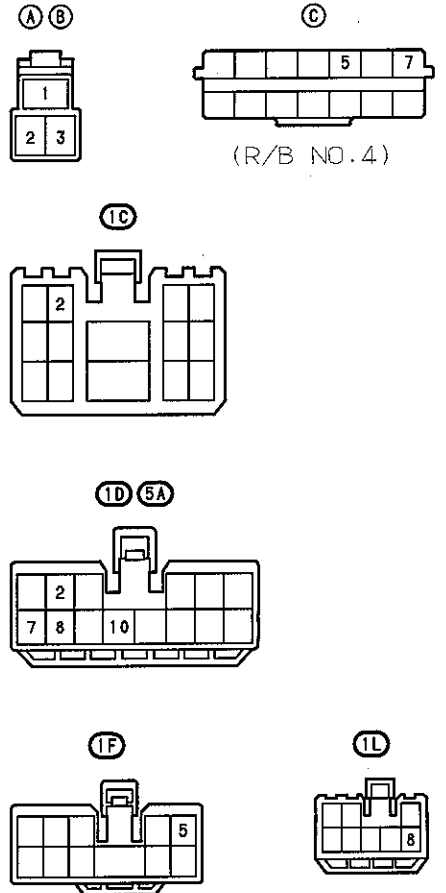
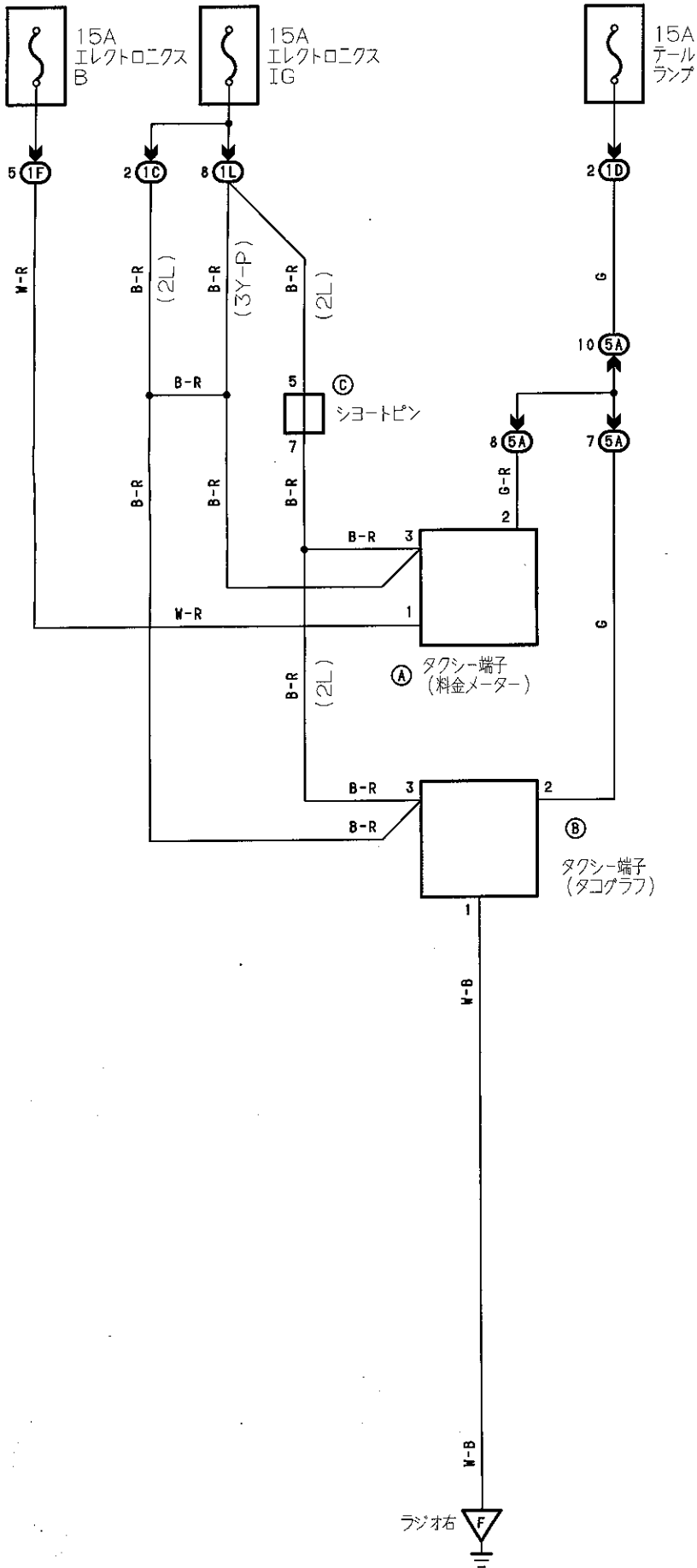



# オートドライブ

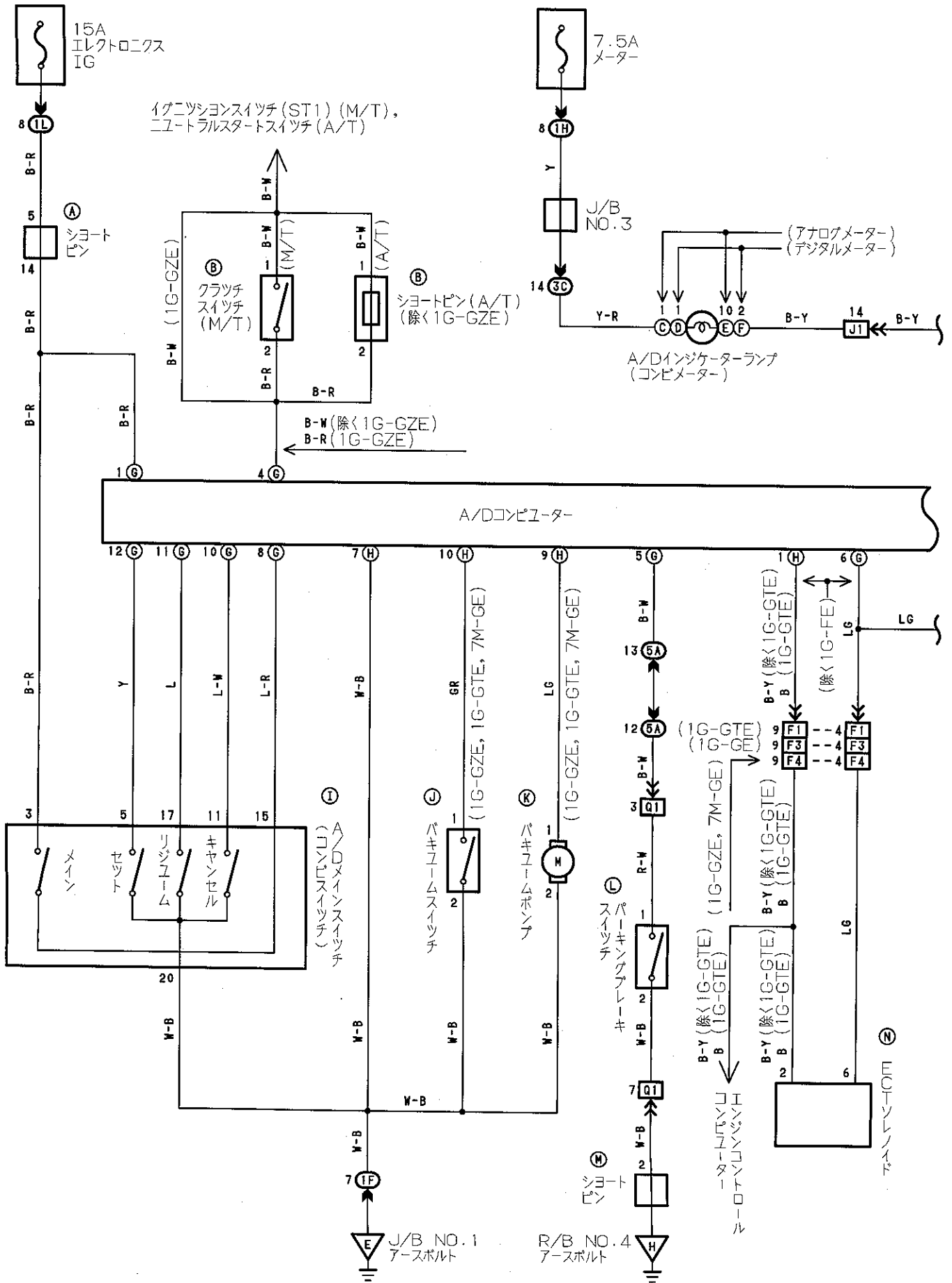



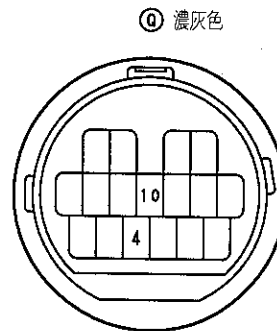
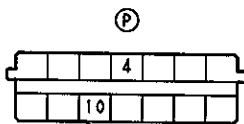
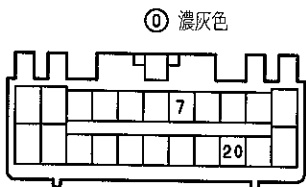
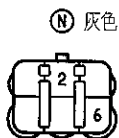
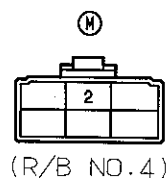
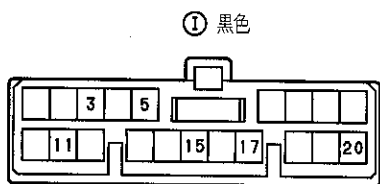
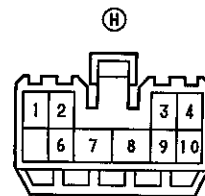
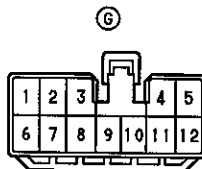
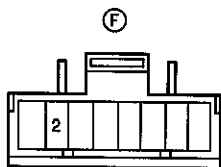
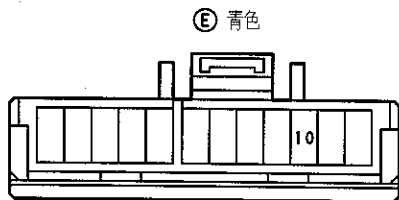
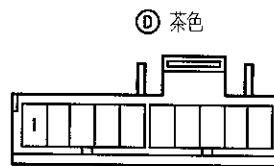
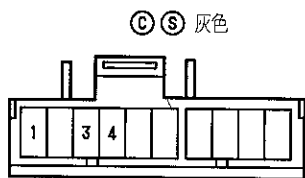
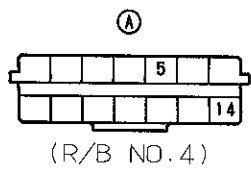

(J/B NO.1)

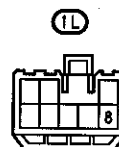
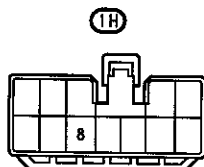
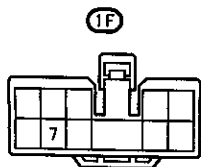
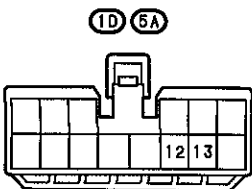
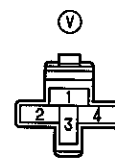
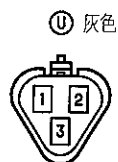
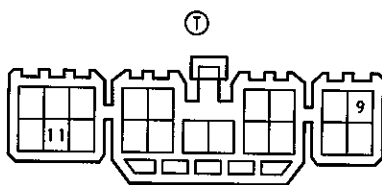
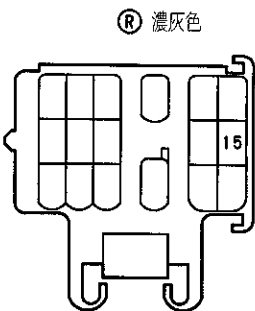

3C 青色

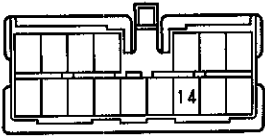

F1 濃灰色

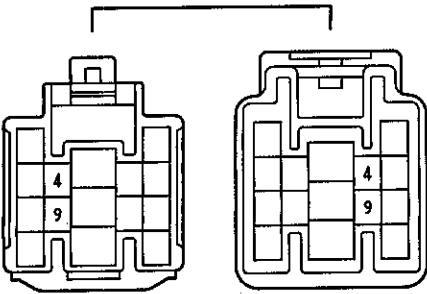

F3 濃灰色

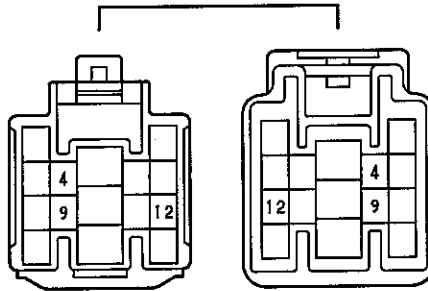

F4 濃灰色

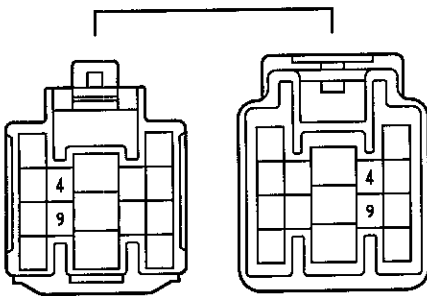

G1

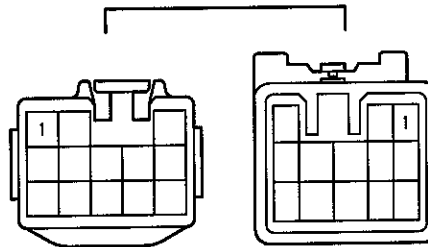

J1

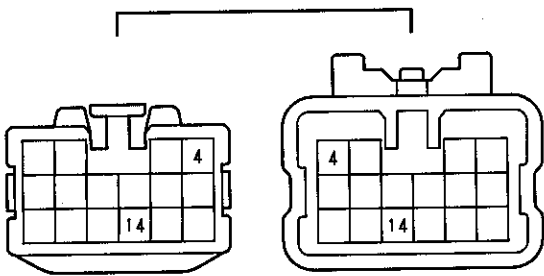

Q1

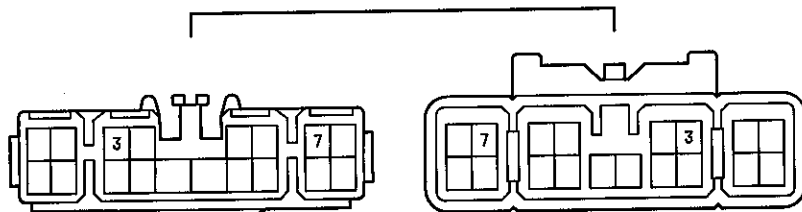

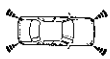

# クリアランスソナー

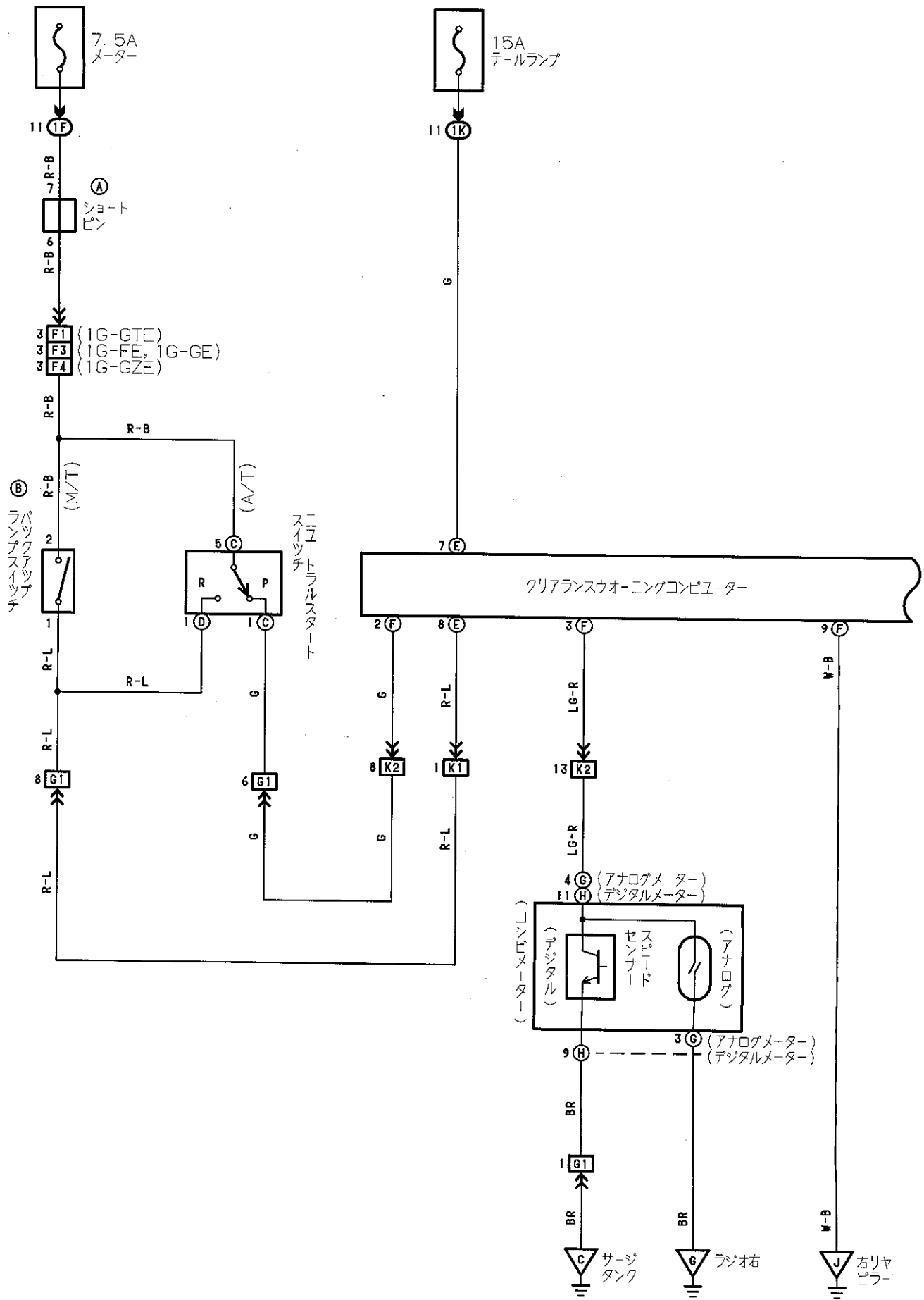

15A  
 イレトロクス  
 IG

11 (IK)

B-R

① クリアランスウォーニング  
 ディスプレイ

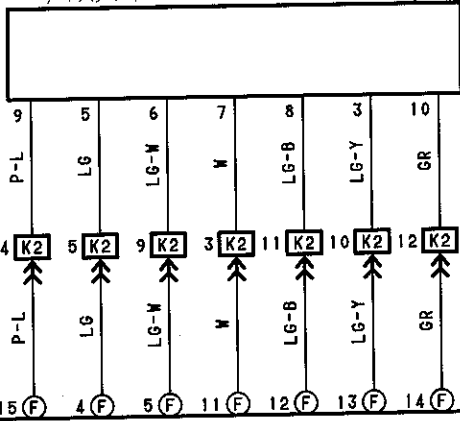

クリアランスウォーニングコンピューター

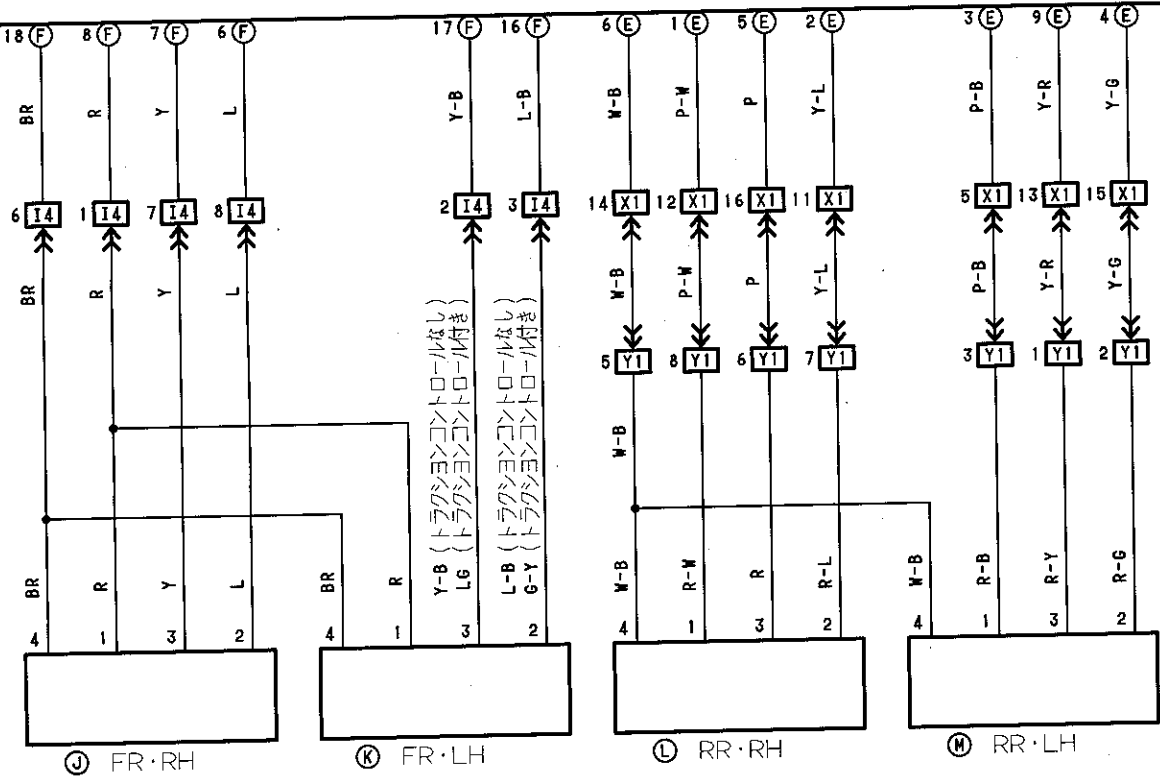

Y-B (トラクションコントロールなし)  
 LG (トラクションコントロール付き)  
 L-B (トラクションコントロールなし)  
 G-Y (トラクションコントロール付き)

クリアランスセンサー

クリアランスソナー

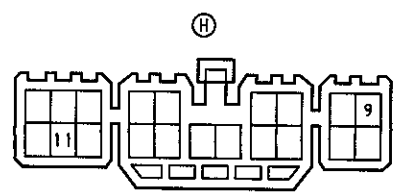
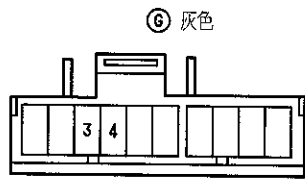
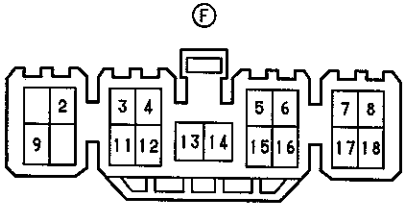
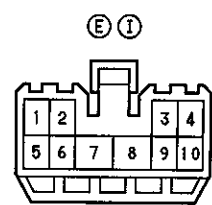
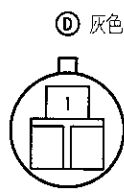
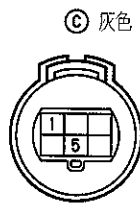
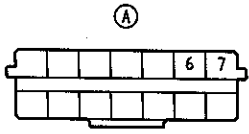

Ⓙ Ⓚ Ⓛ Ⓝ

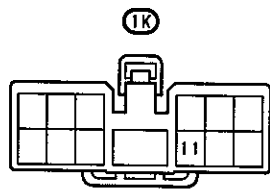
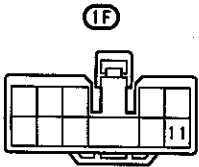
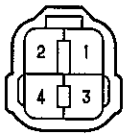

Ⓛ 濃灰色

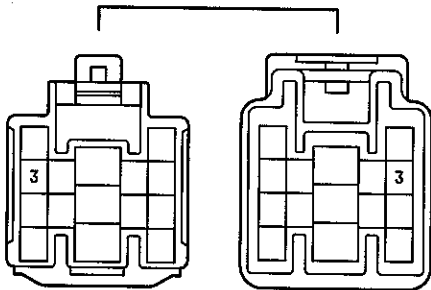

Ⓜ 濃灰色

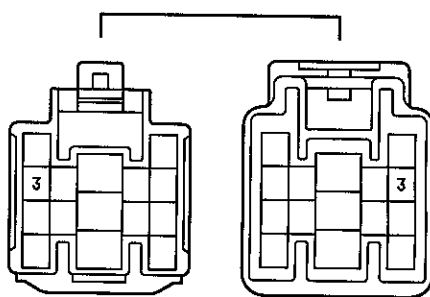

Ⓨ 濃灰色

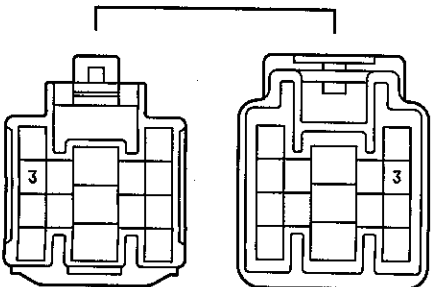

Ⓩ

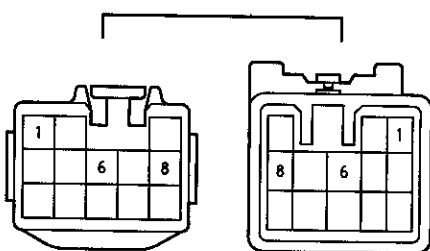

I4 濃灰色

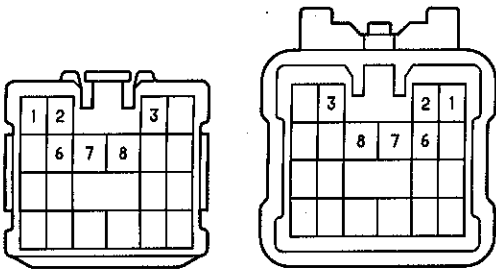

K1 だいだい色

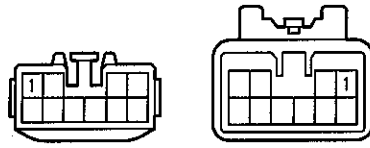

K2 灰色

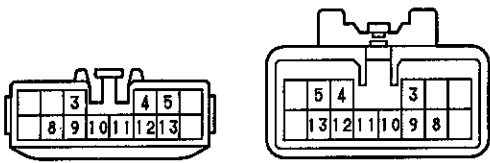

X1 黒色

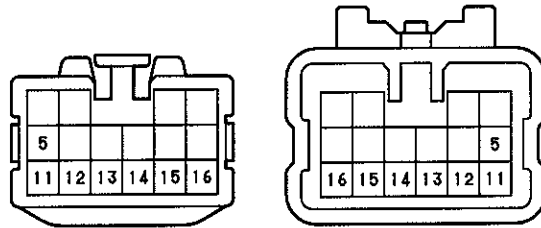

Y1

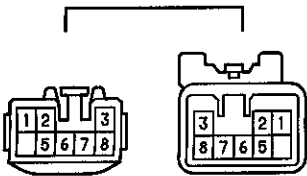



# ラジオ & ステレオ(6スピーカー)

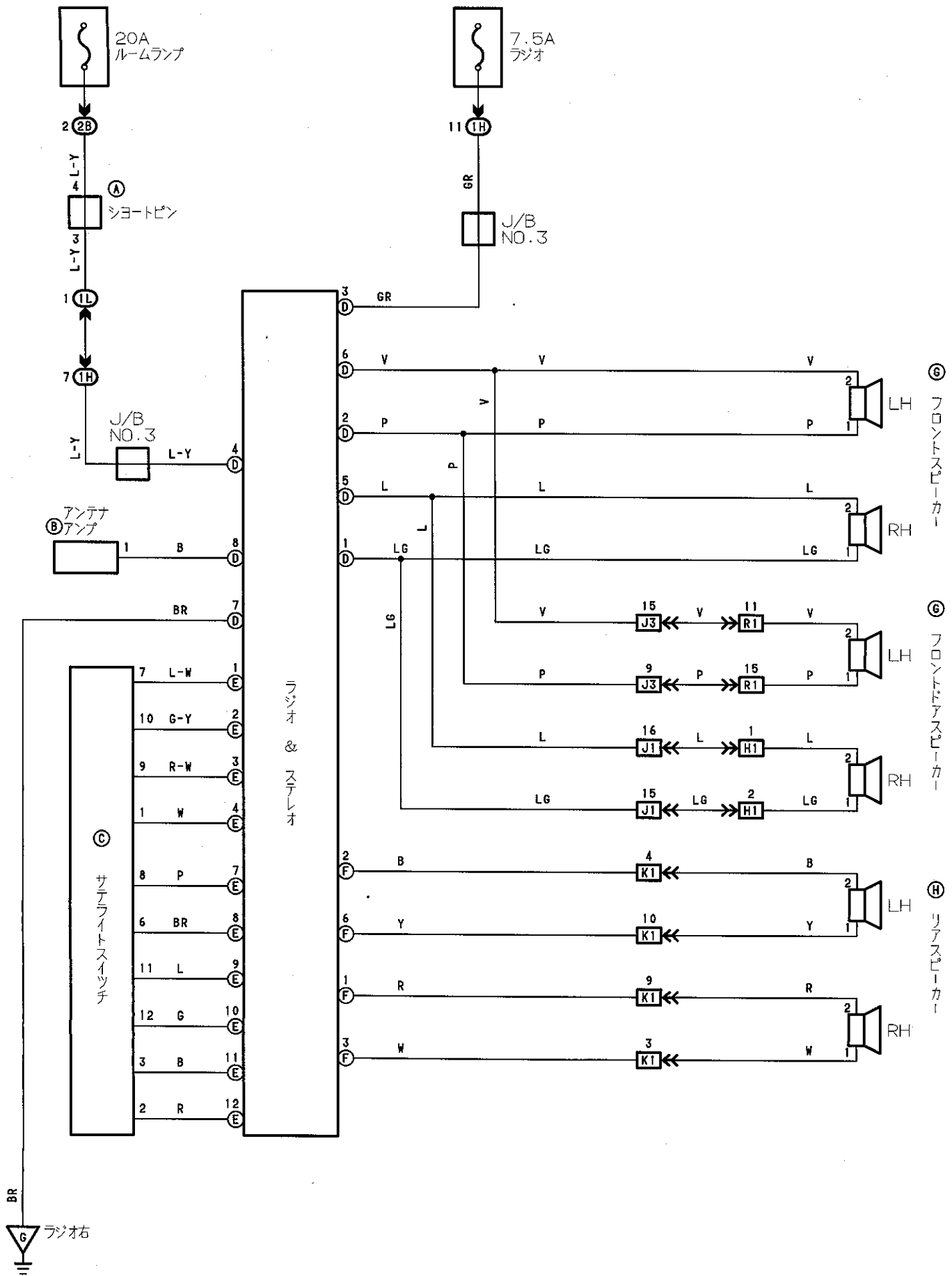

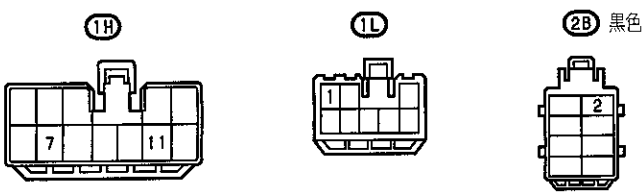
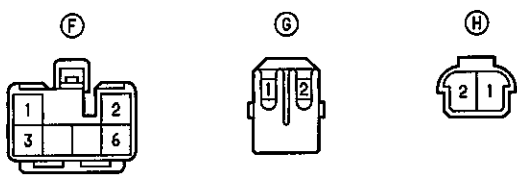
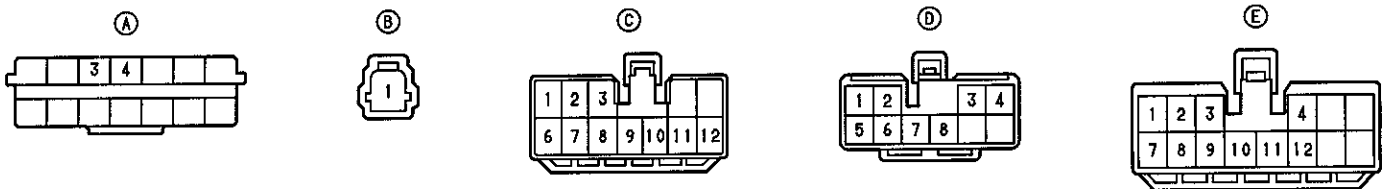

**H1** 青色

**J1 J3**

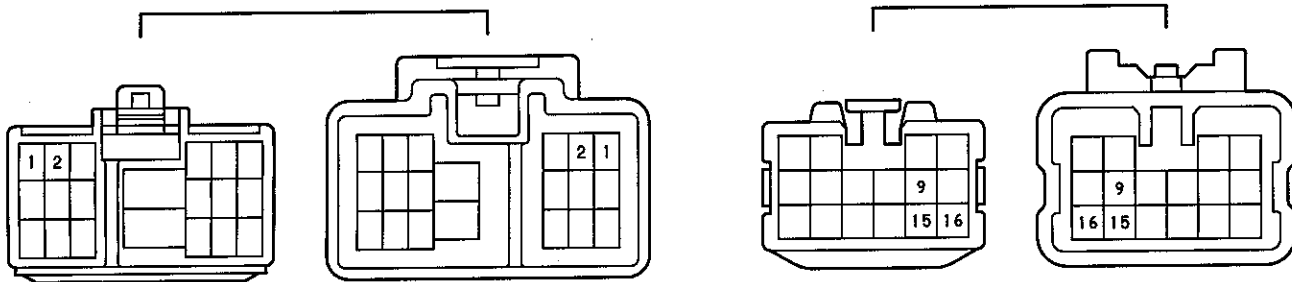

**K1** だいたい色

**R1** 青色

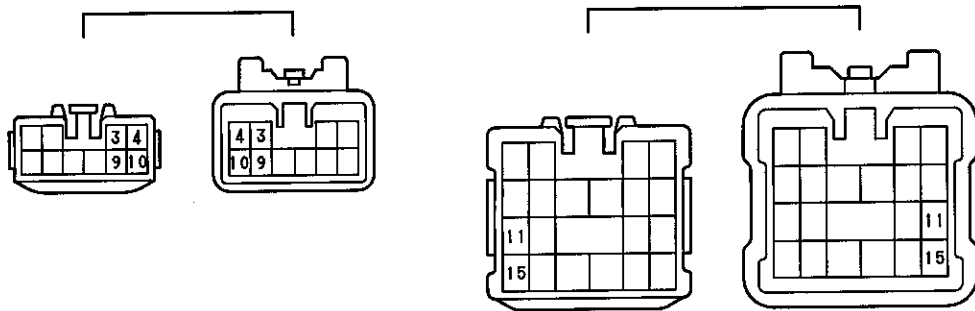



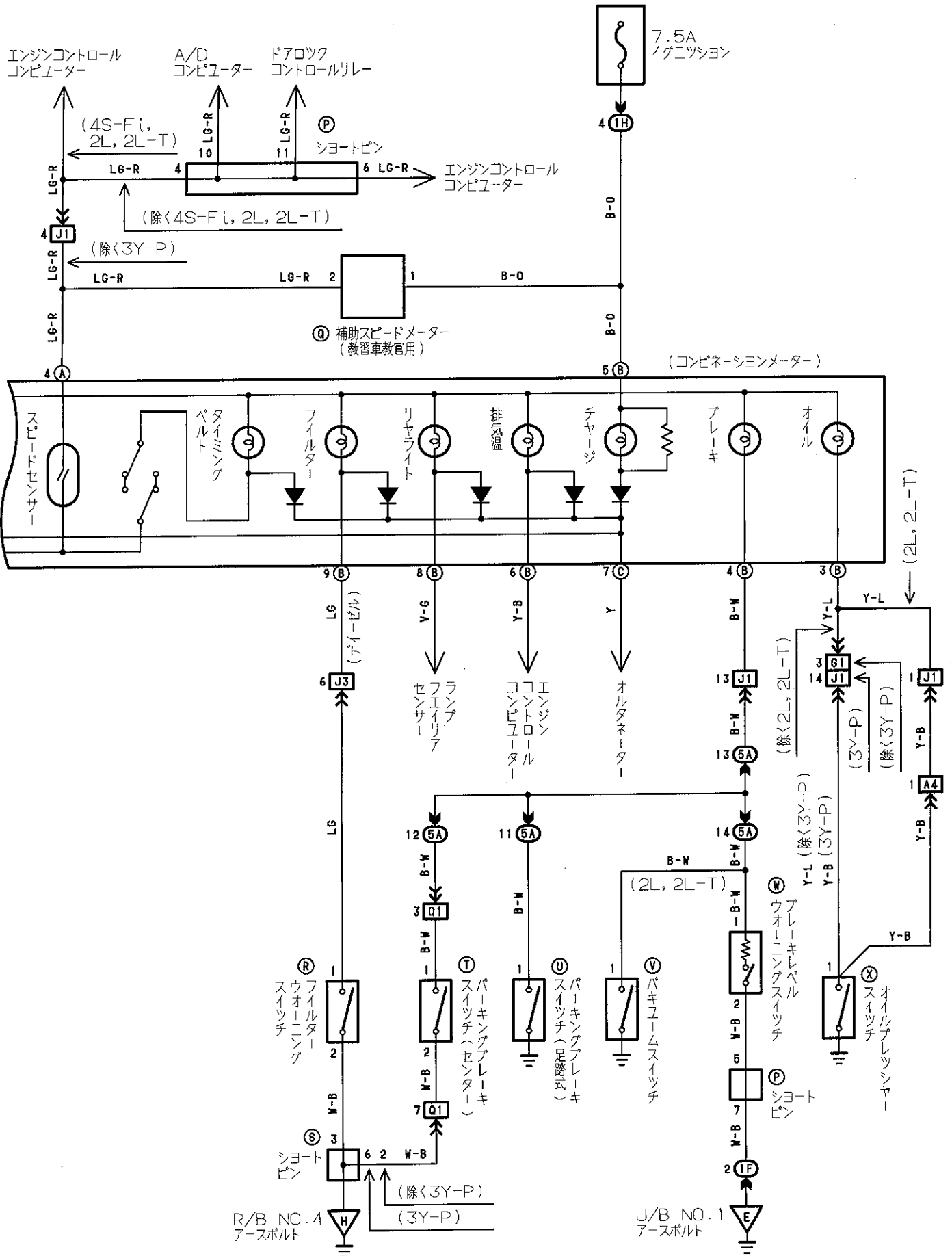



# コンビネーションメーター (アナログ)

Ⓐ 灰色

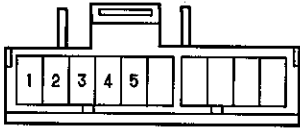

Ⓑ 青色

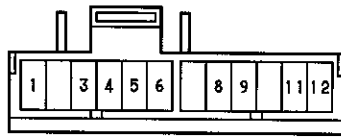

Ⓒ 茶色

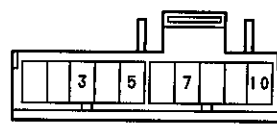

Ⓓ 灰色



Ⓔ 灰色



Ⓕ



Ⓖ 灰色

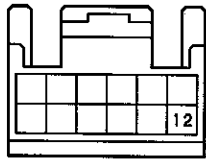

Ⓗ 濃緑色



Ⓘ 黒色



Ⓙ 濃灰色



Ⓚ Ⓛ 濃灰色

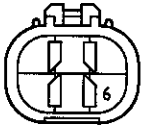

Ⓜ

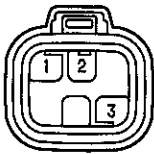

Ⓝ



Ⓞ Ⓟ



Ⓟ

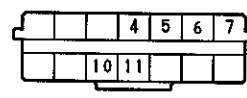

(J/B NO. 1)

Ⓠ

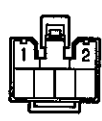

Ⓡ



Ⓢ

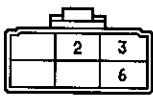

(R/B NO. 4)

Ⓣ



(J/B NO. 5)

Ⓡ



Ⓜ 灰色



Ⓧ 黒色



Ⓛⓕ

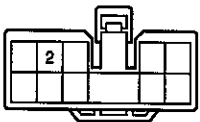

Ⓛⓓ

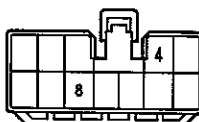

ⓈⒸ 青色

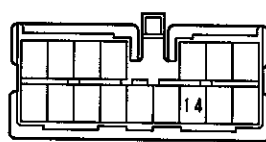

ⓈⒶ

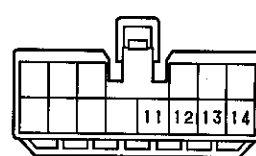

ⒶⒶ 灰色

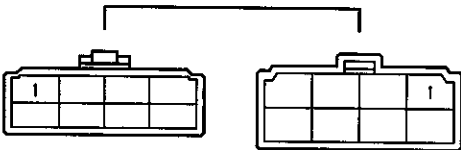

ⒶⒻ

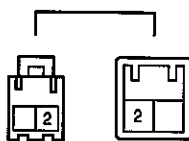

ⒶⓁ

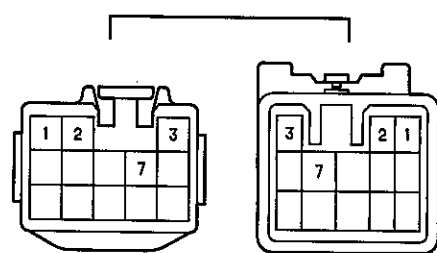

J1 J3

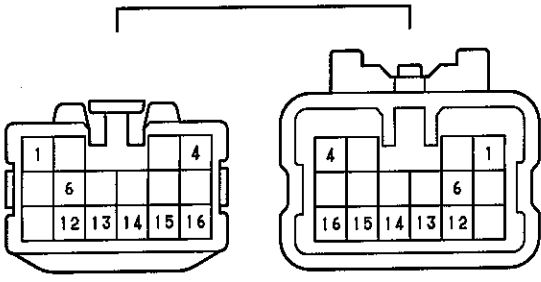

K1 だいたい色

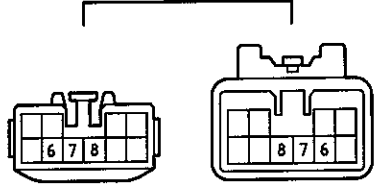

Q1

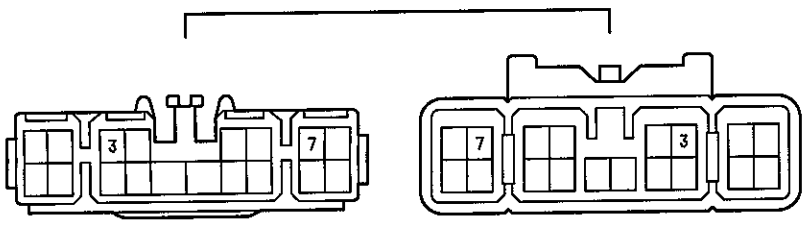



J1 J3

K1 だいたい色

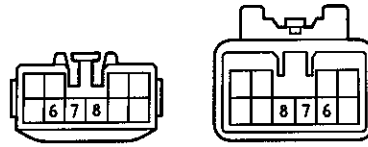
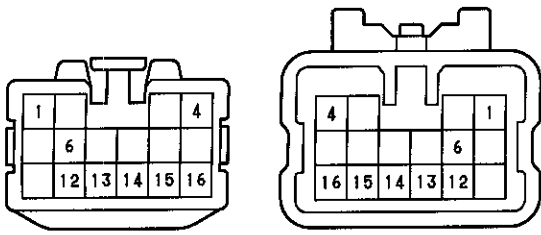

Q1

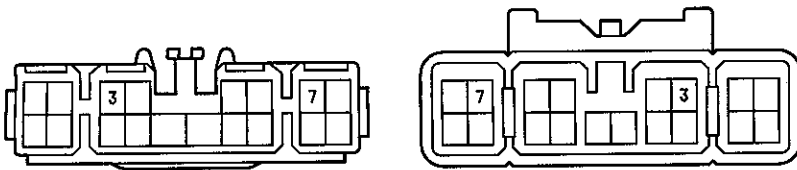



# コンビネーションメーター (デジタル)

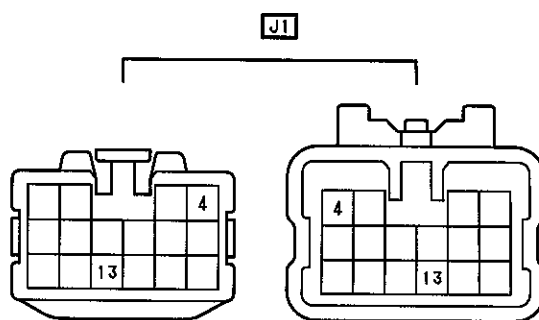
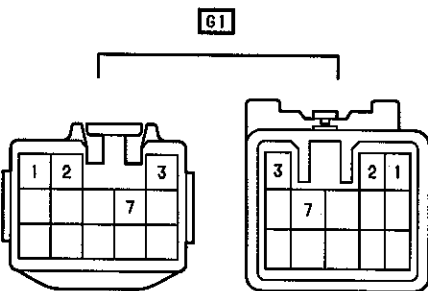
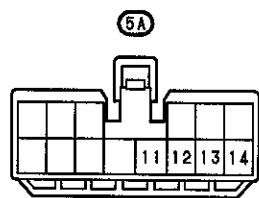
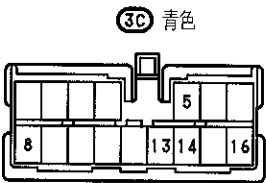
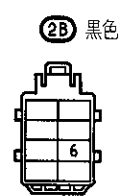
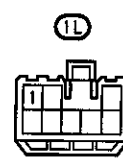
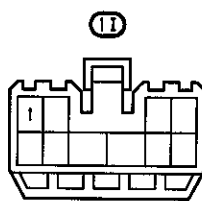
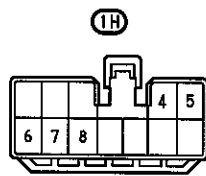
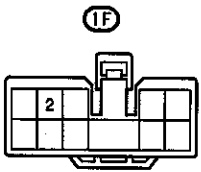
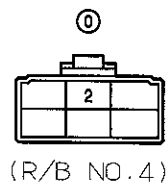
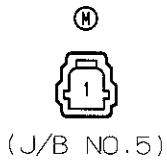
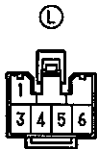
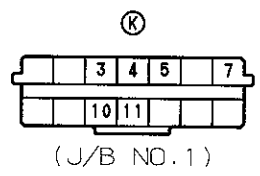
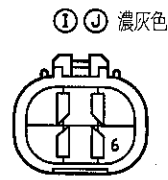
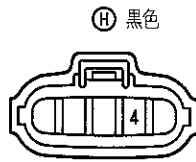
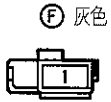
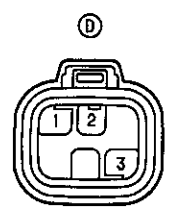
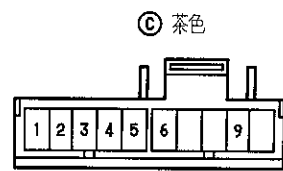
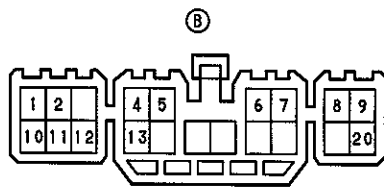
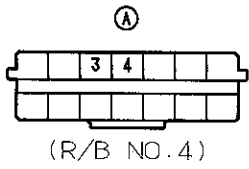

K1 だいだい色

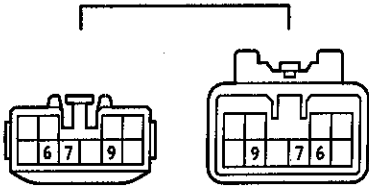

Q1

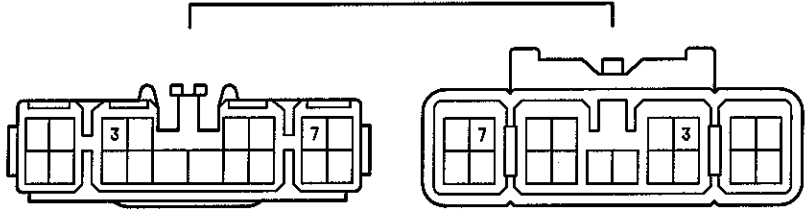



# ラジエーターファン & マニュアルエアコンディショナー

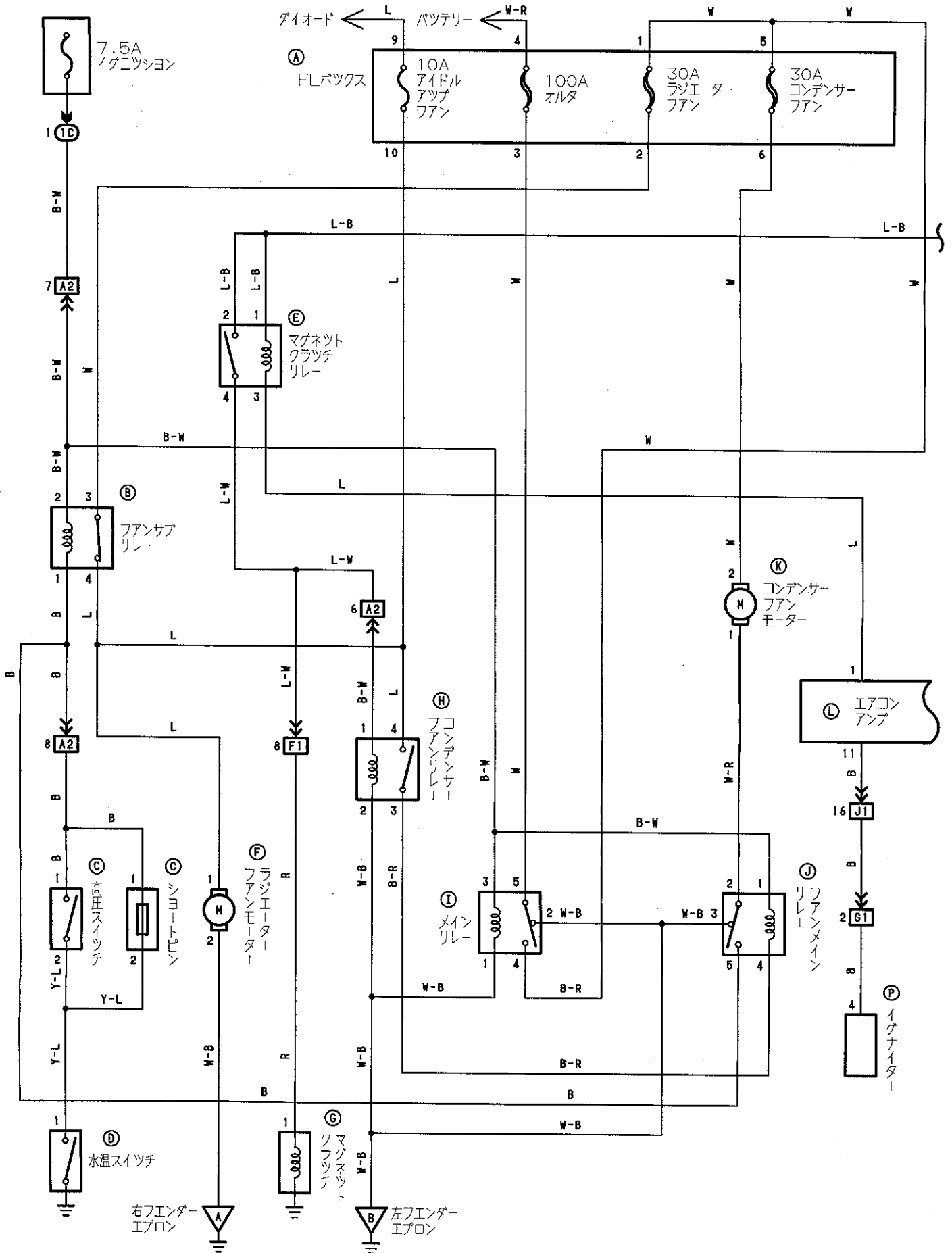

# (レバー式4S-F)

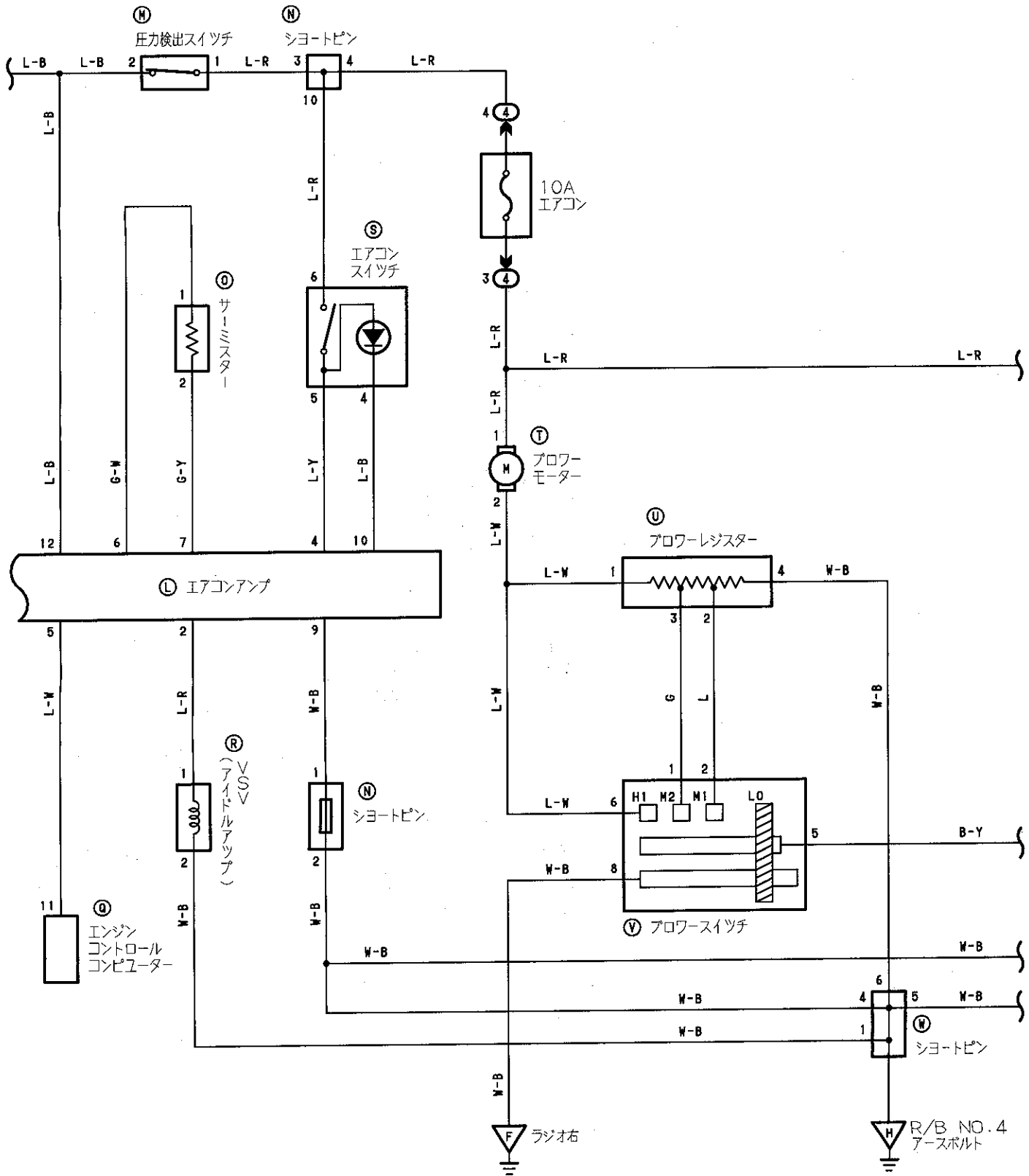

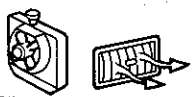

# ラジエーターファン & マニュアルエアコン

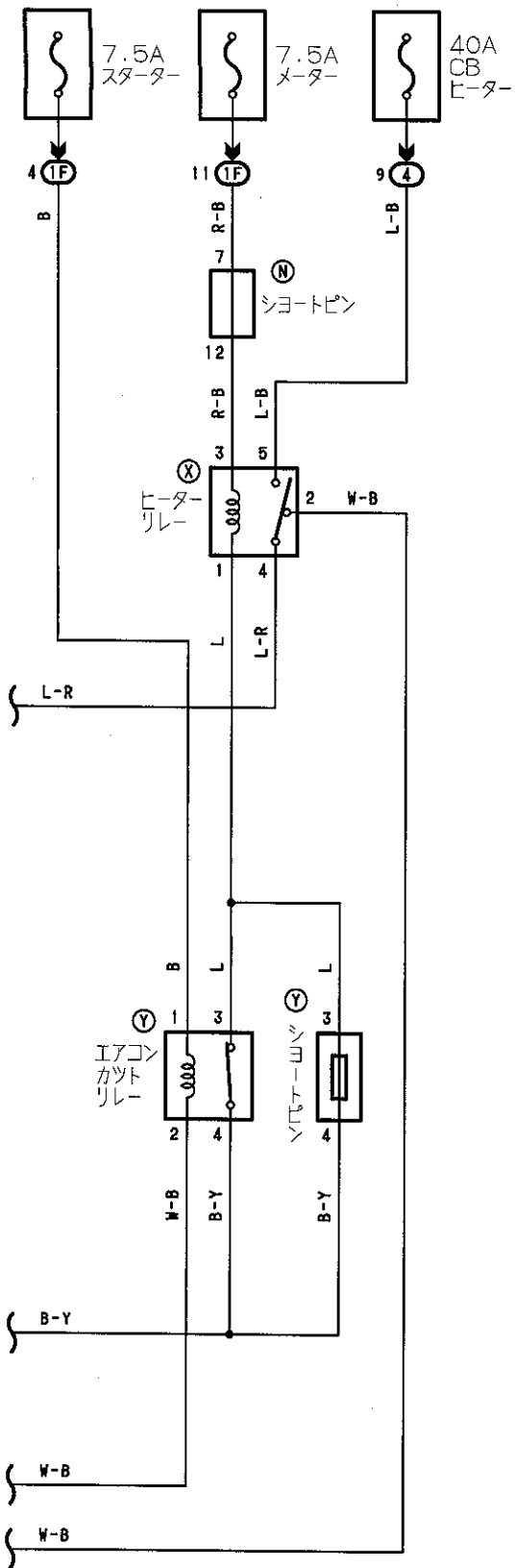

- (A) 黒色
- (B) (R/B NO.6)
- (C) 黒色
- (D)
- (E)
- (F)
- (G) 灰色
- (H) 灰色
- (I) (R/B NO.6)
- (J) (R/B NO.6)
- (K) 黒色
- (L)
- (M) 灰色
- (N)
- (O) 青色
- (P) 黒色
- (Q) 濃灰色
- (R)
- (S)
- (T)
- (U)
- (V) 青色
- (W) (R/B NO.4)
- (X) (R/B NO.4)
- (Y)

(レバー式4S-Fi)

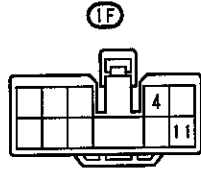
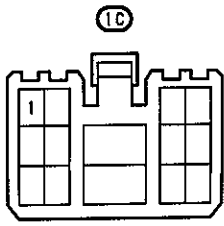

A2 灰色

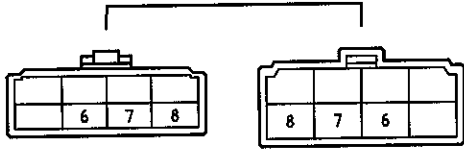

F1 濃灰色

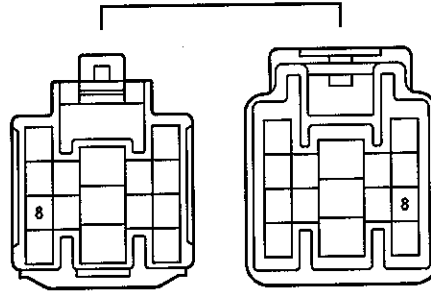

G1 黄色

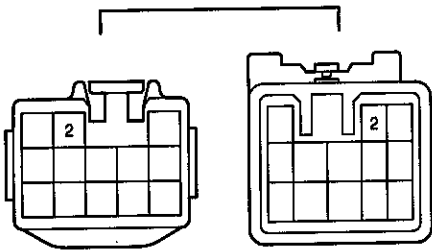

J1

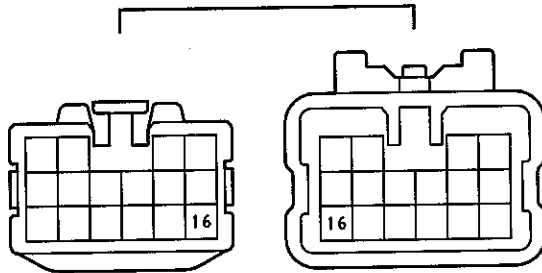



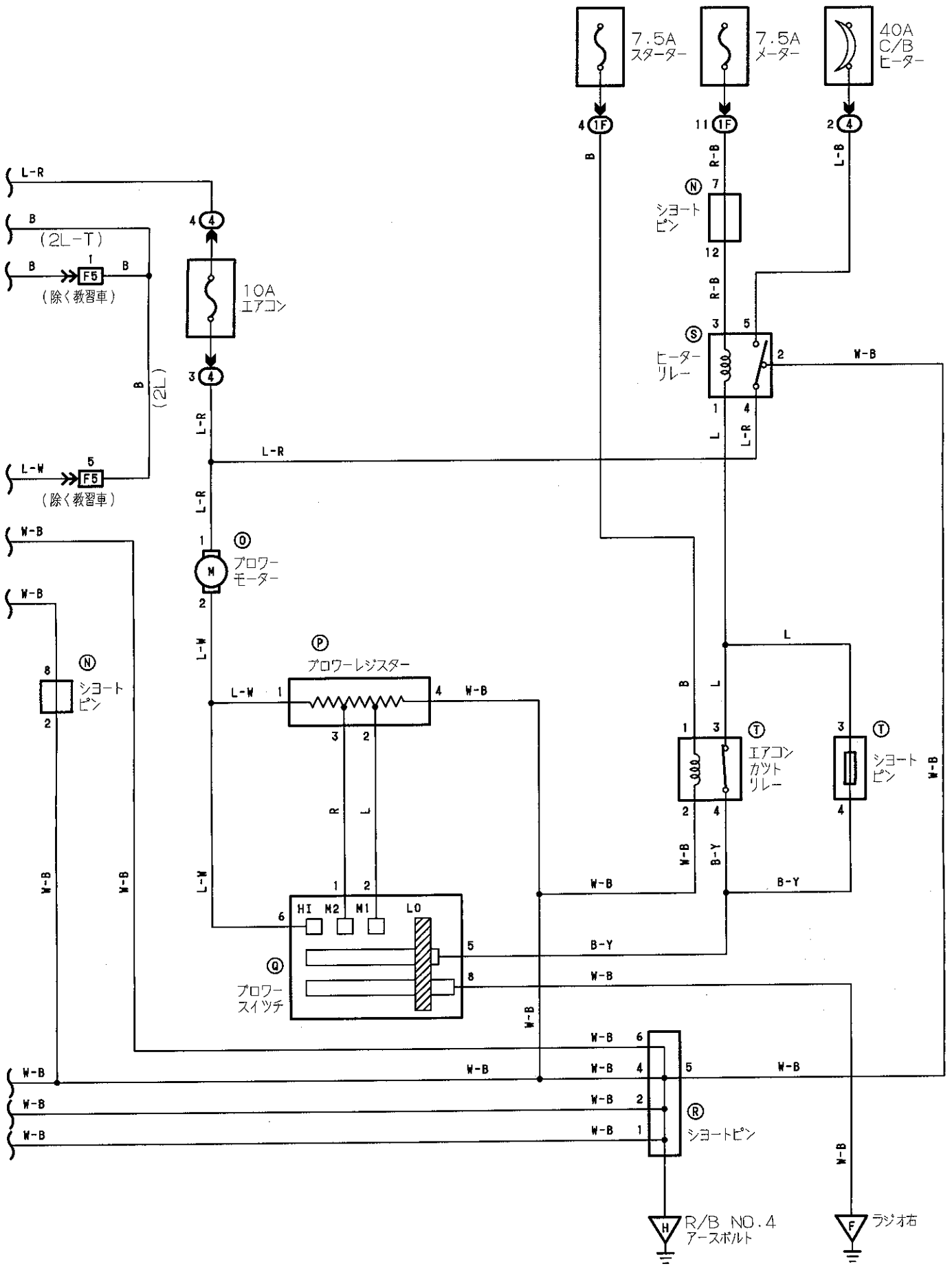



# マニュアルエアコンデショナー (レバー式2L, 2L-T)

**A** 黒色

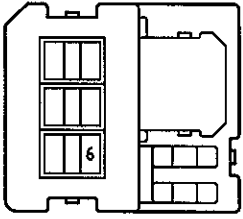

**B**

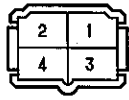

**C** 灰色

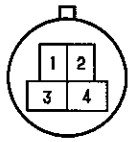

**D** 黒色



**E** 黒色



**F** 灰色



**G** 灰色

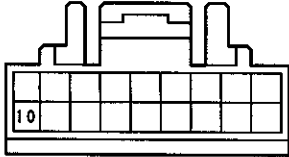

**H** 0

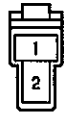

**I**

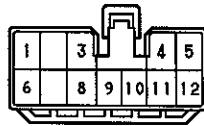

**J**



**K** 濃灰色

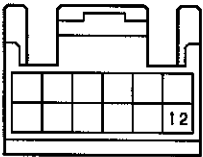

**L** 青色



**M** 灰色



**N**

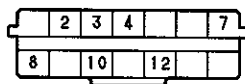

**P**



**Q** 青色

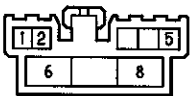

**R**

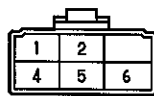

(R/B NO.4)

**S**



(R/B NO.4)

**T**

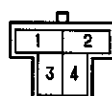

**U**

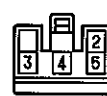

**1F**

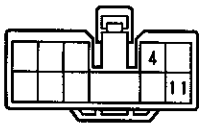

**A2** 灰色

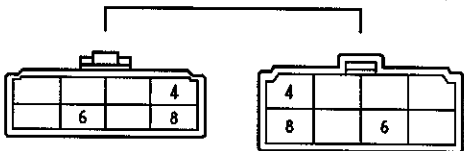

**F3** 濃灰色

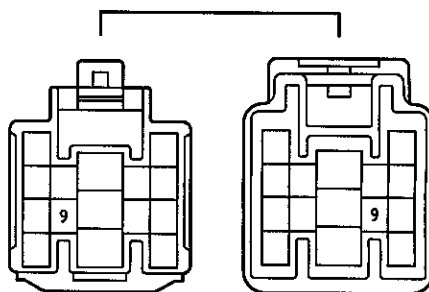

F5 濃灰色

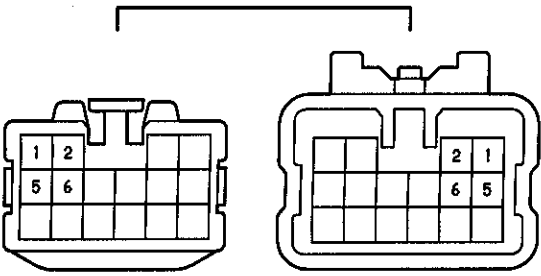

M1

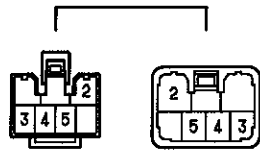

H2

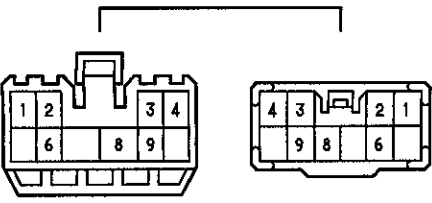



# マニュアルエアコンデিশヨナー (3Y-P)

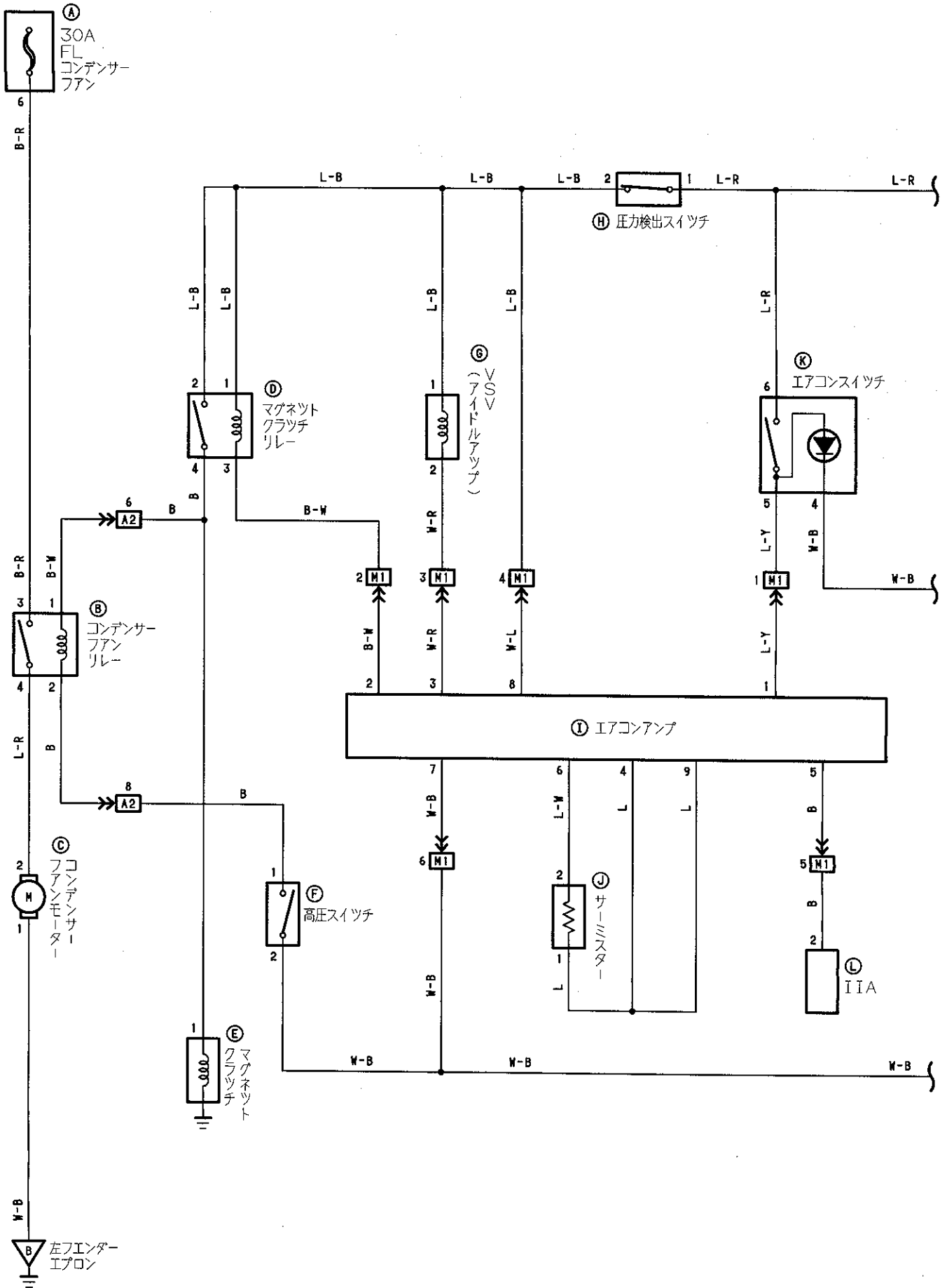

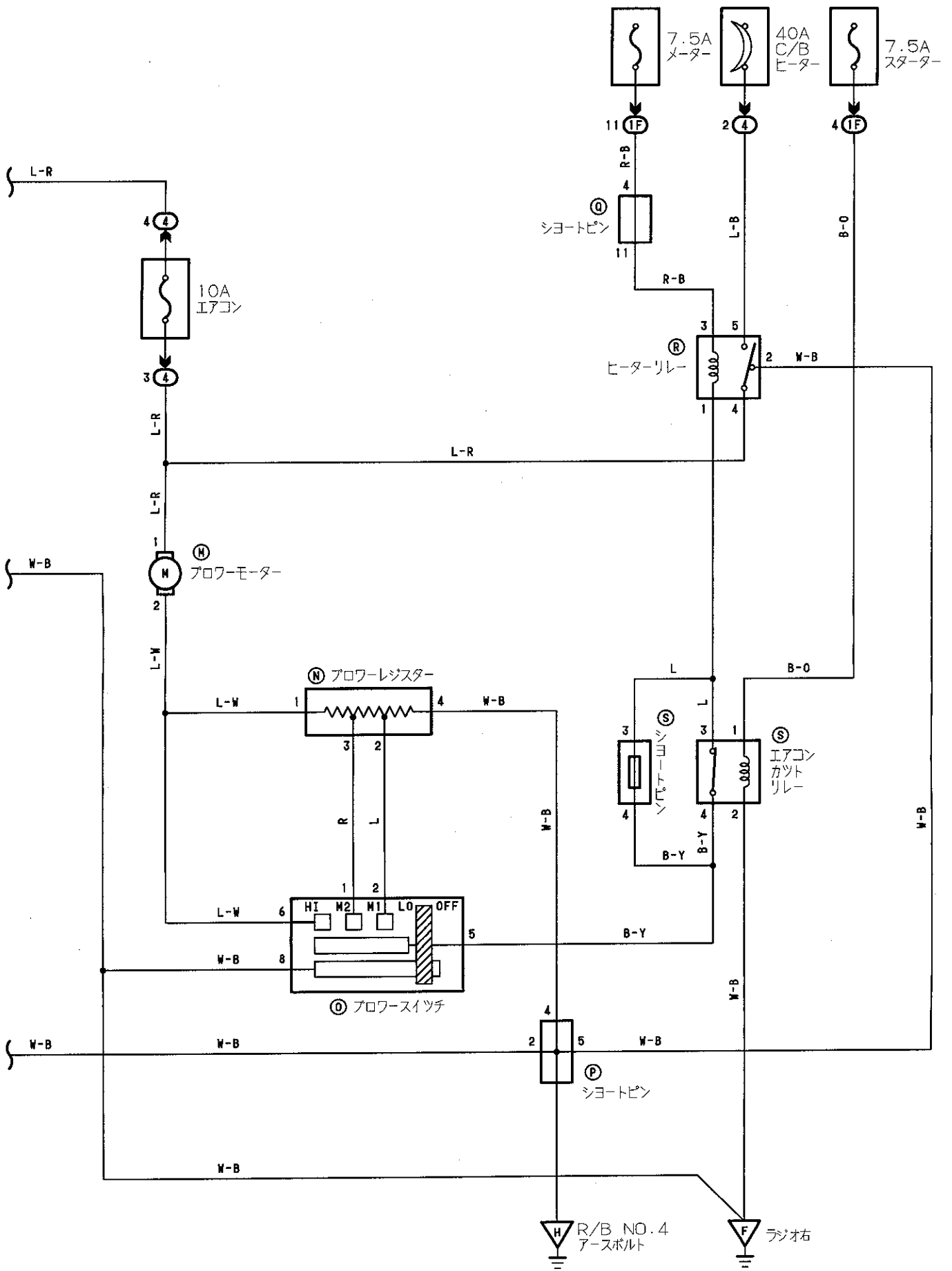

# マニュアルエアコンデショナー (3Y-P)

Ⓐ 黒色

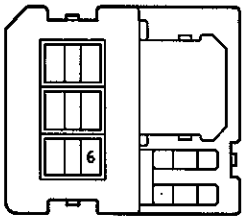

Ⓑ 灰色



Ⓒ 黒色



Ⓓ

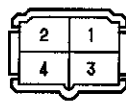

Ⓔ 灰色



Ⓕ 黒色



Ⓖ Ⓜ

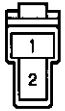

Ⓗ 灰色



Ⓘ

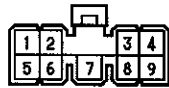

Ⓙ



Ⓚ 青色



Ⓛ 濃緑色



Ⓝ



Ⓩ 青色

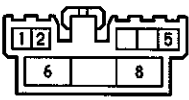

Ⓟ

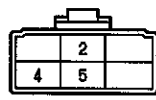

(R/B NO.4)

Ⓠ

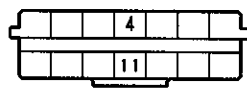

Ⓡ



(R/B NO.4)

Ⓢ

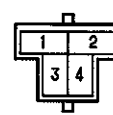

Ⓣ

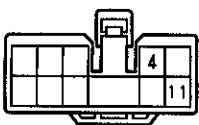

Ⓐ2 灰色

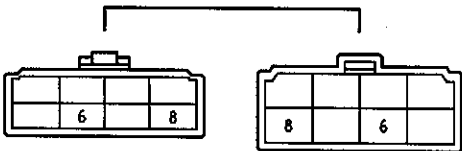

Ⓜ1

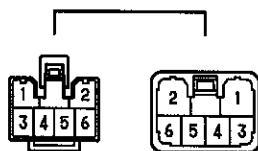

# ラジエーターファン & エアコンディショナー(4S-FI Eグレード)

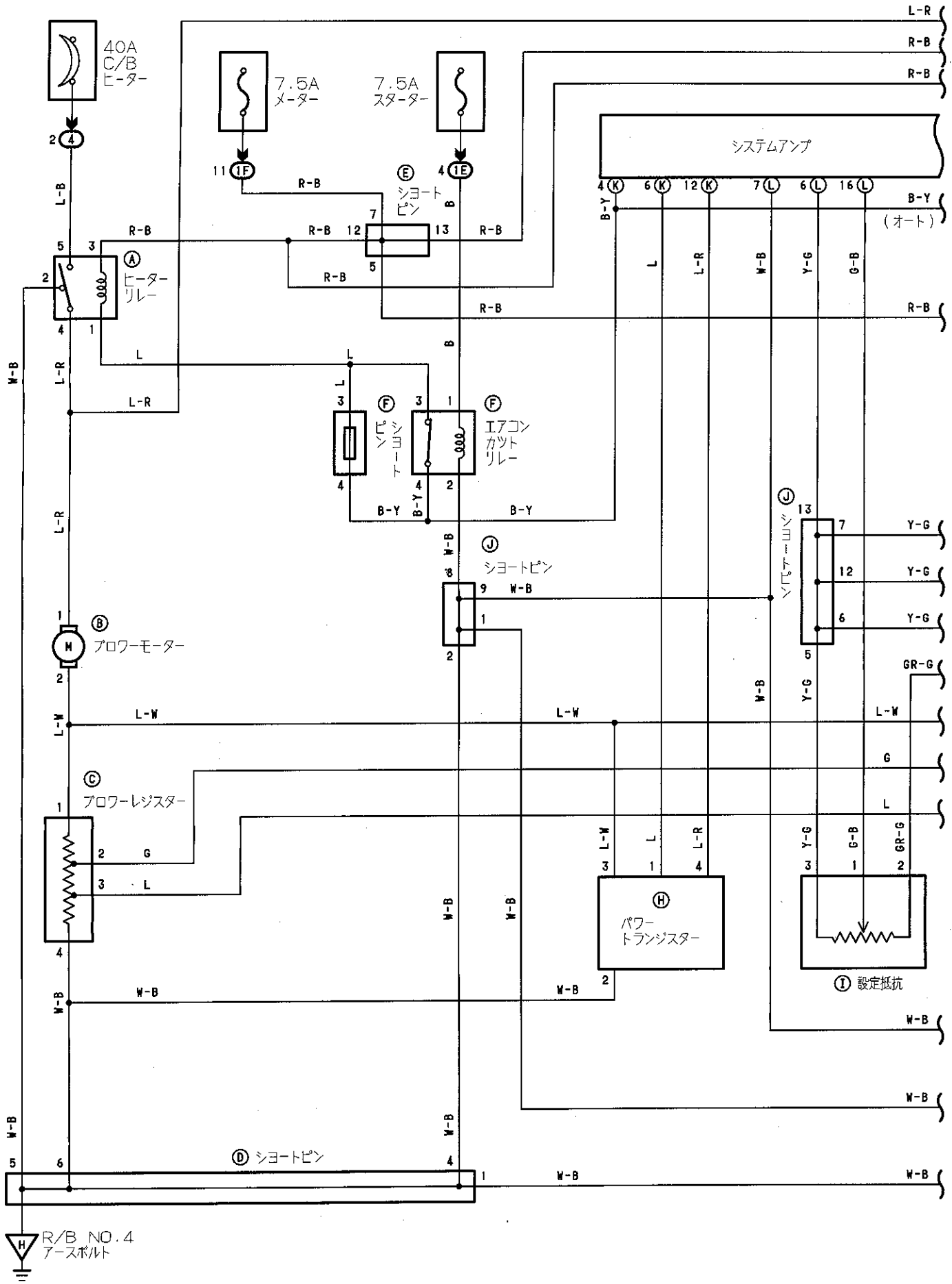



# ラジエーターファン & エアコンディショナー

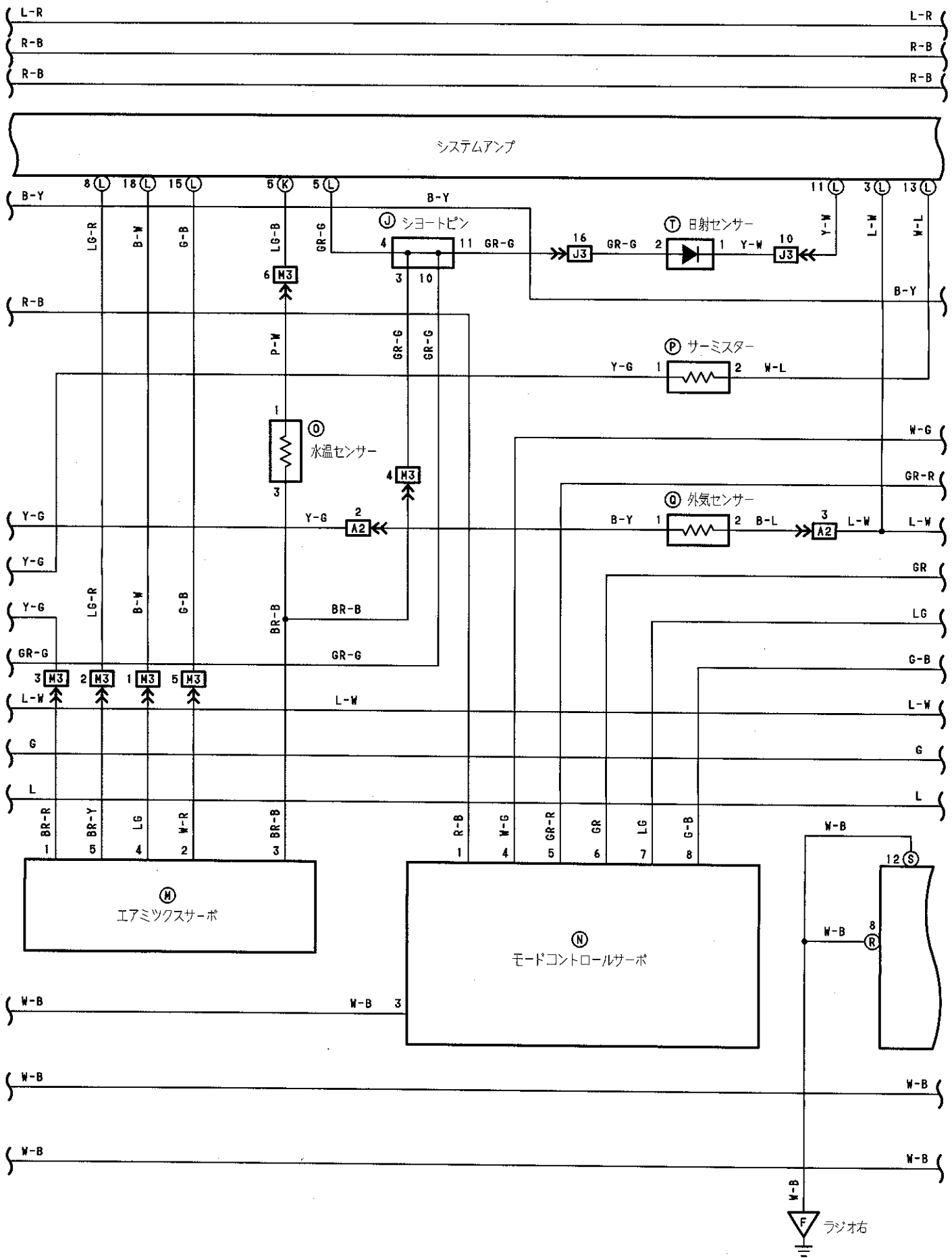

# (4S-FI Eグレード)

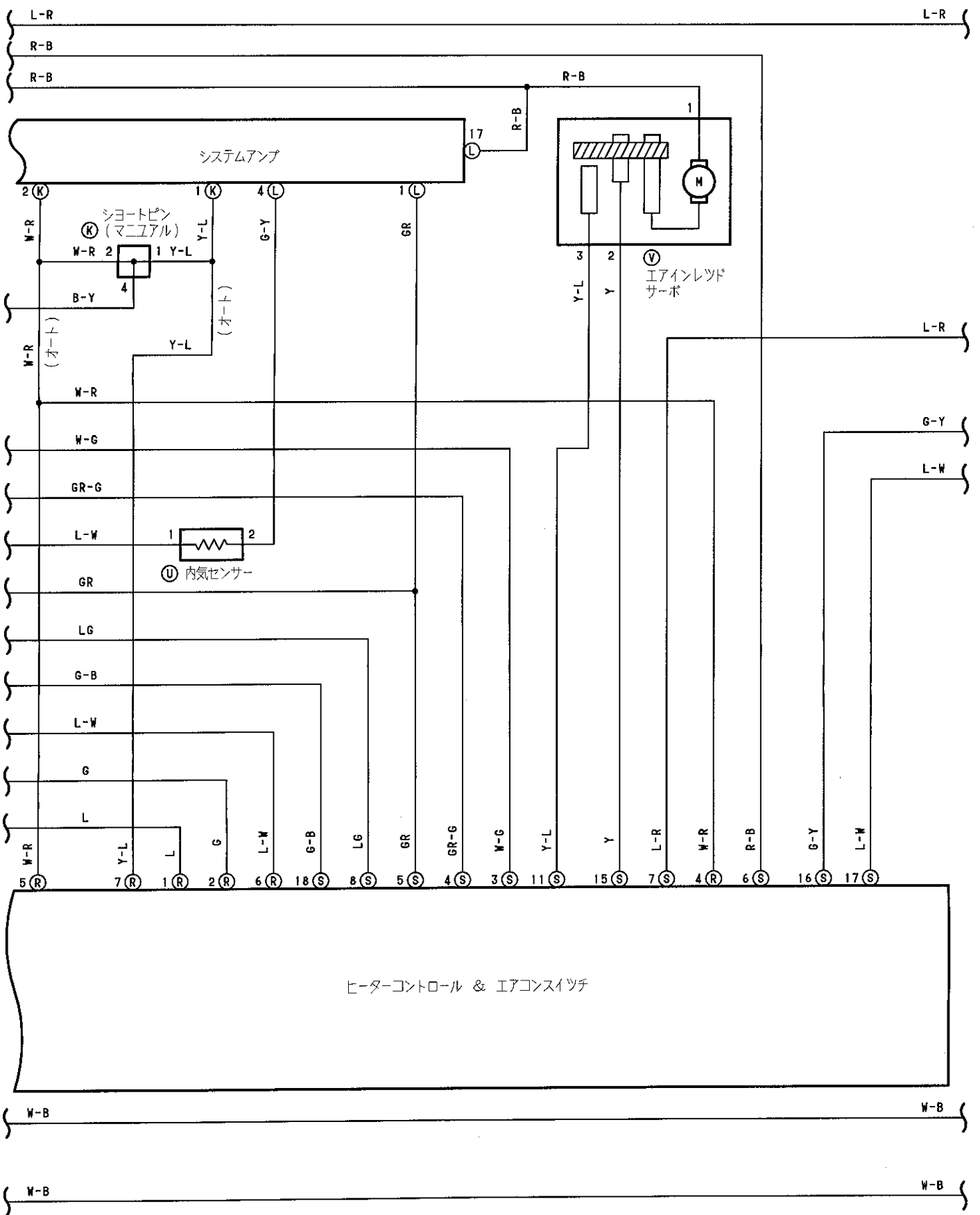



# ラジエーターファン & エアコンデিশヨナー

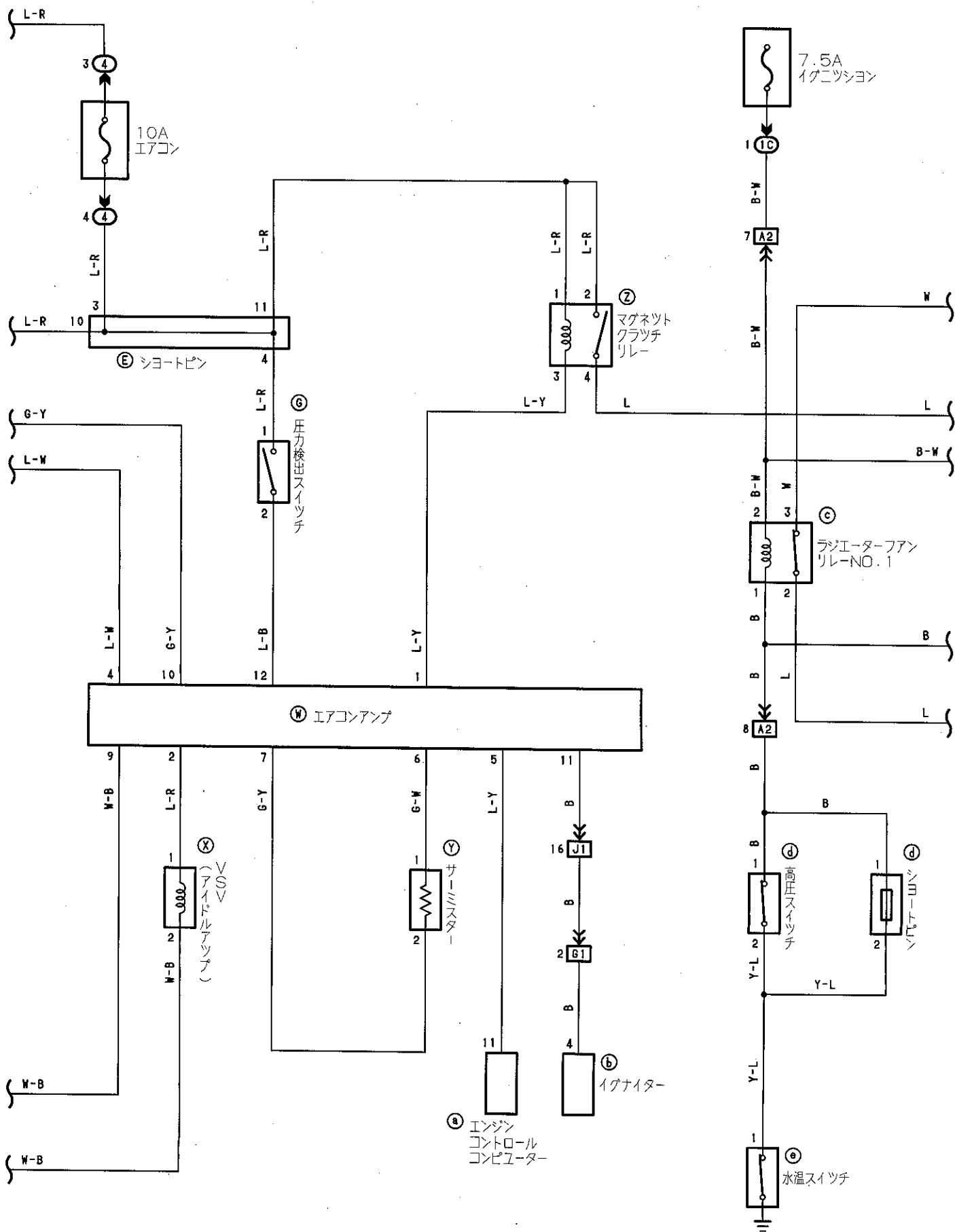

# (4S-FI Eグレード)

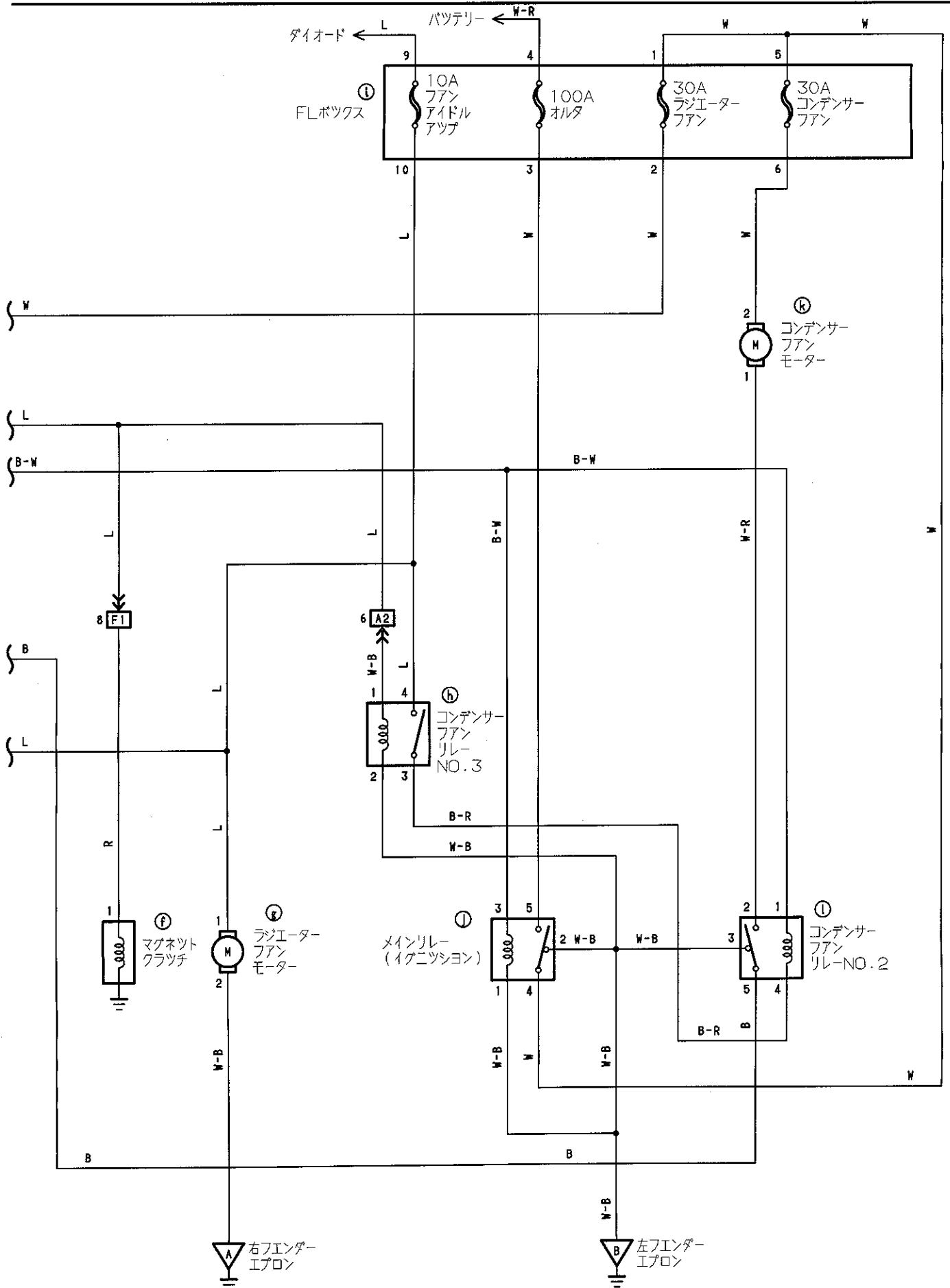



# ラジエーターファン & エアコンディショナー

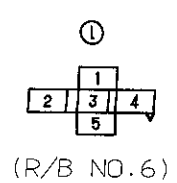
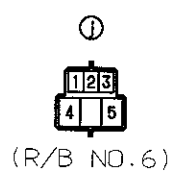
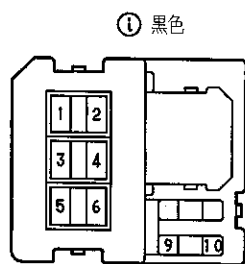
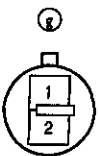
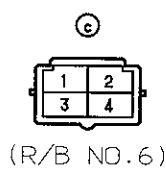
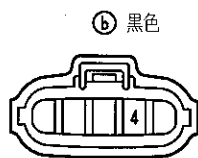
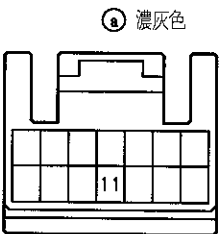
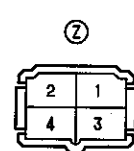
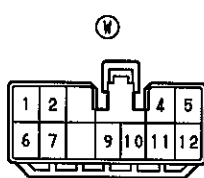
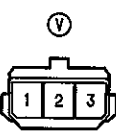
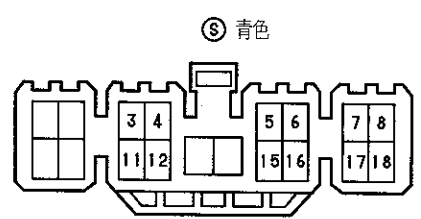
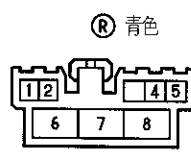
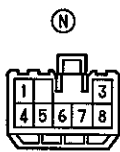
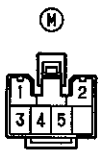
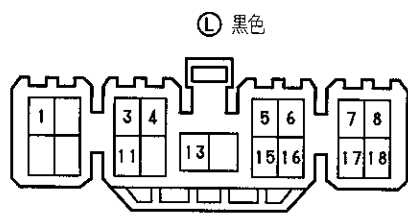
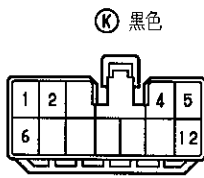
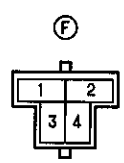
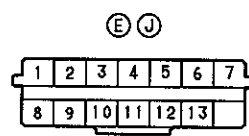
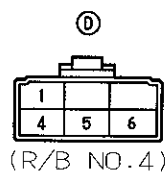
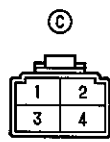
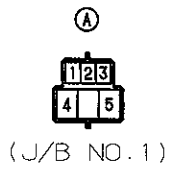

# (4S-Fi Eグレード)

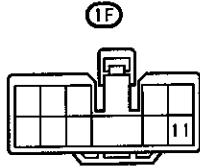
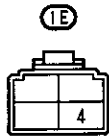
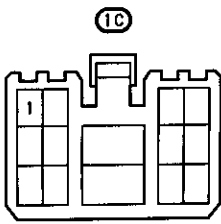

A2 灰色

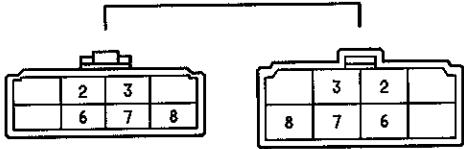

F1 濃灰色

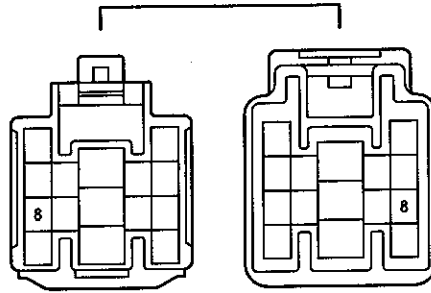

G1

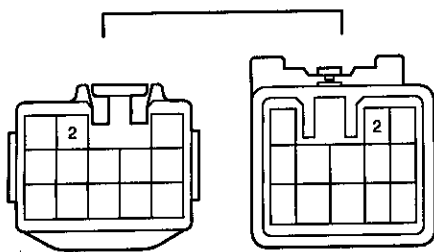

J1 J3

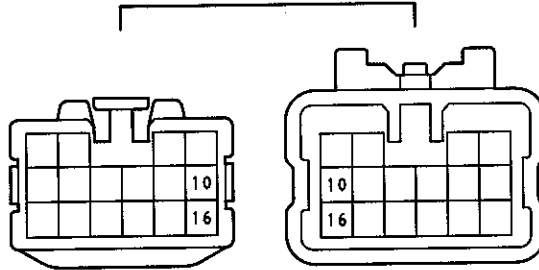

M3

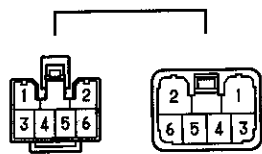



# エアコンディショナー (Gグレード)

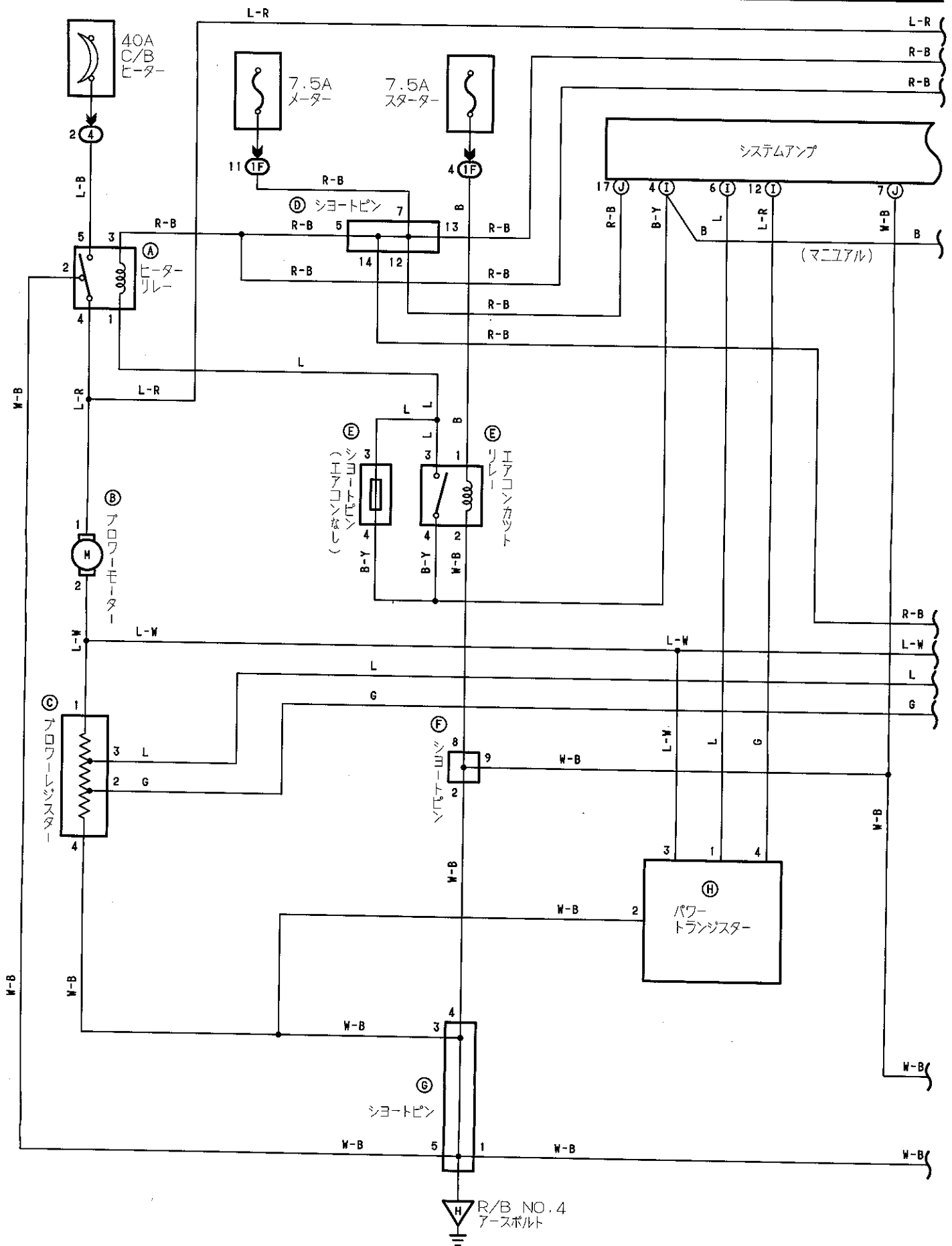

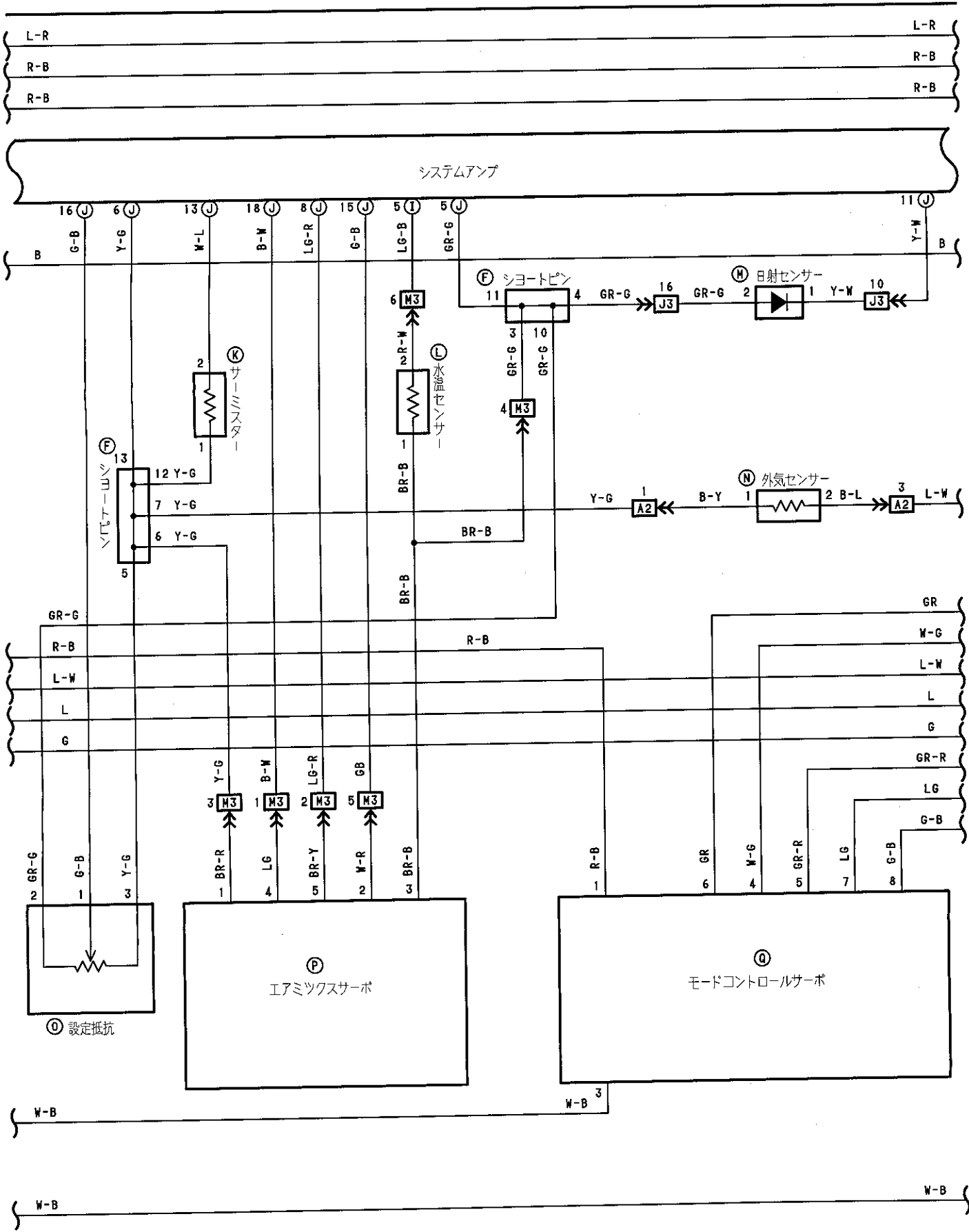

# エアコンディショナー (Gグレード)

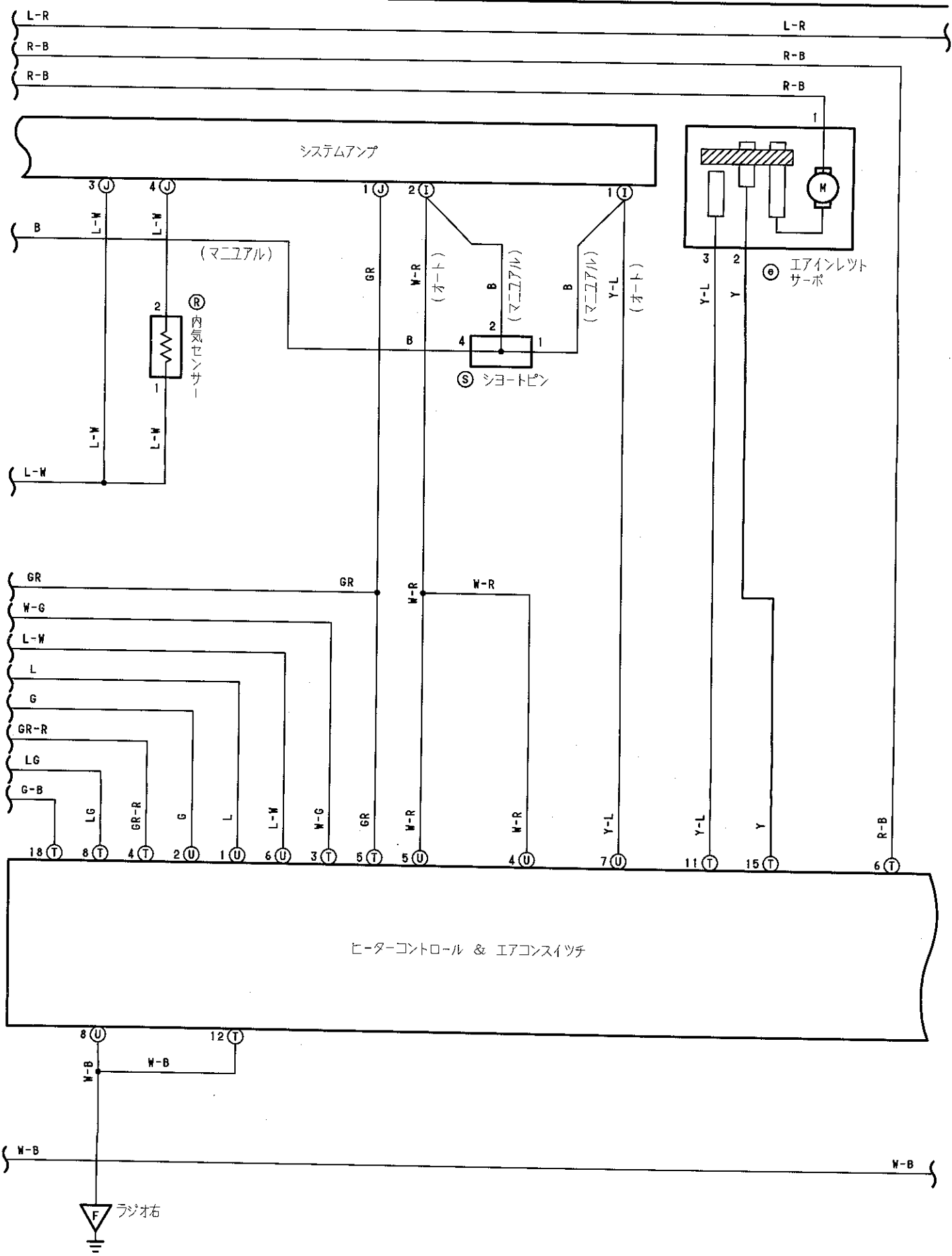

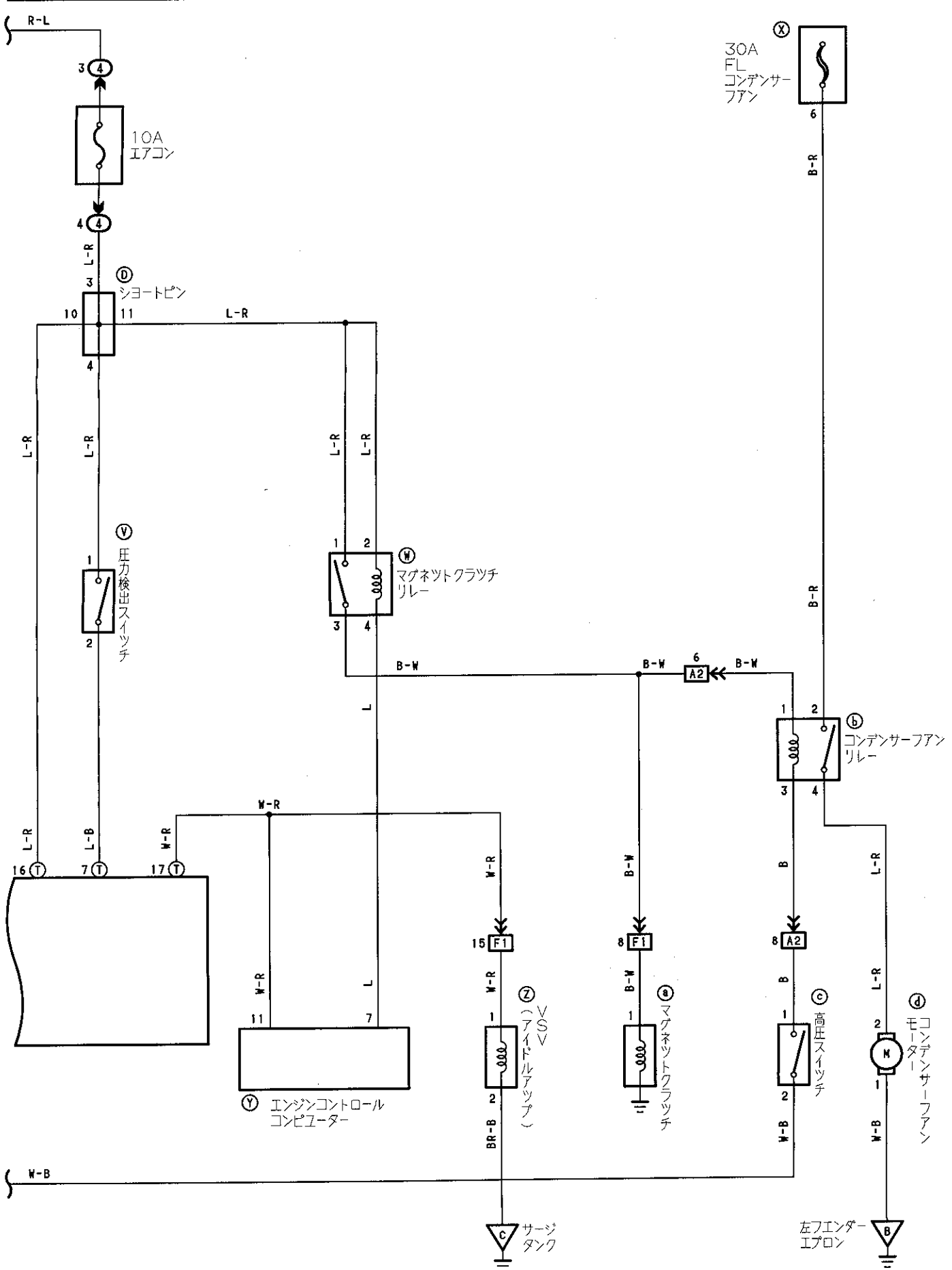



# エアコンデিশヨナー (Gグレード)

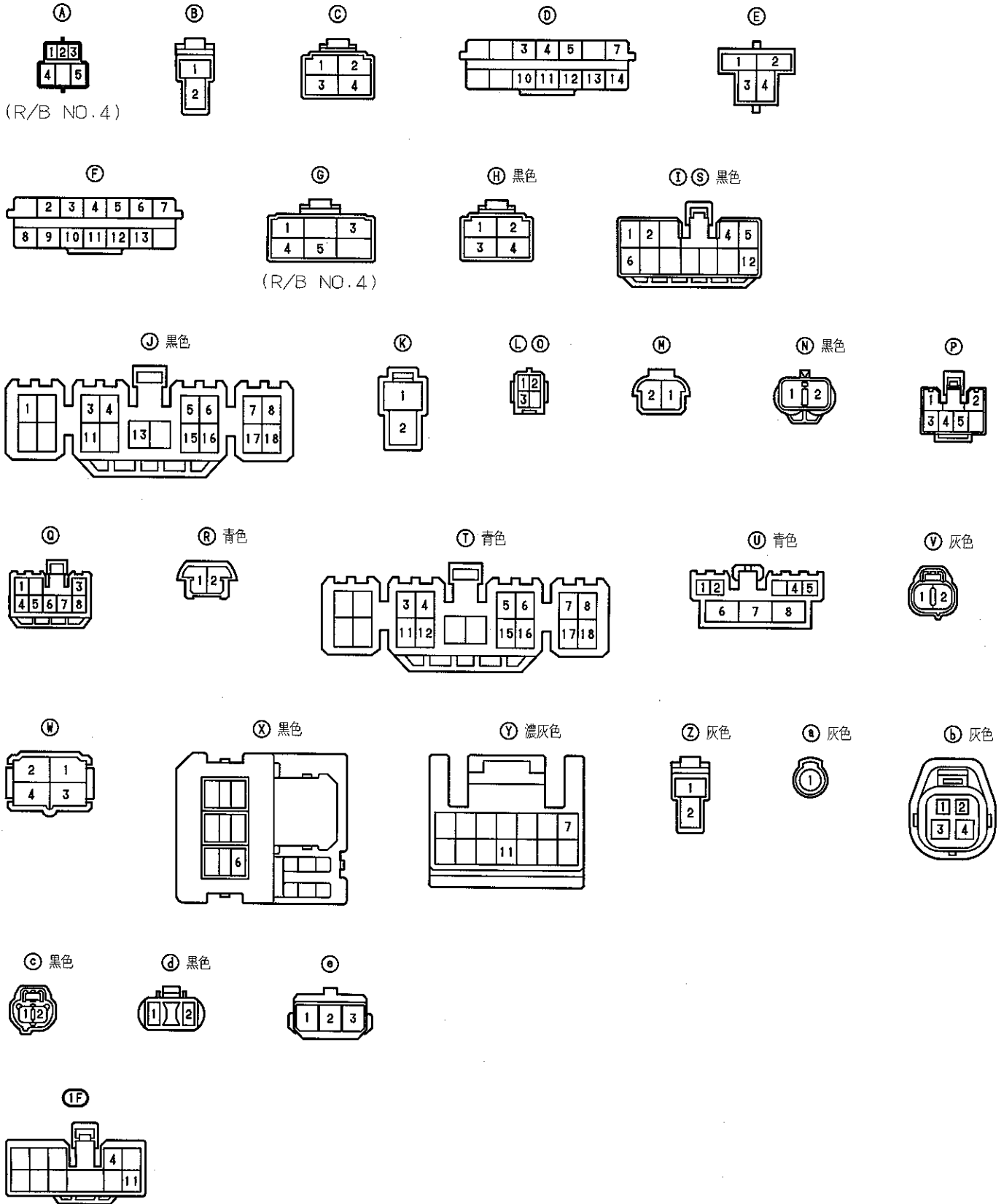

**A2** 灰色

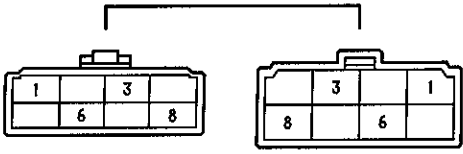

**F1** 濃灰色

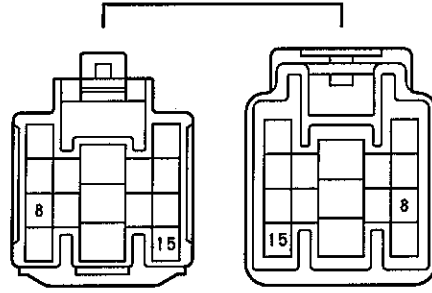

**J3**

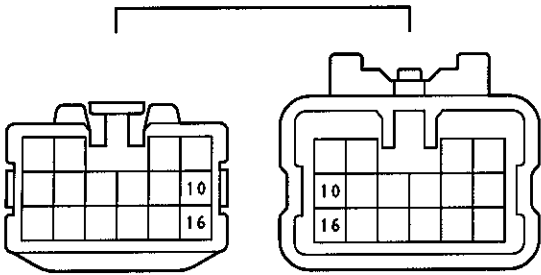

**M3**

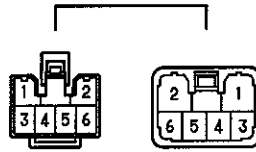



# オートエアコンディショナー(2L-T)

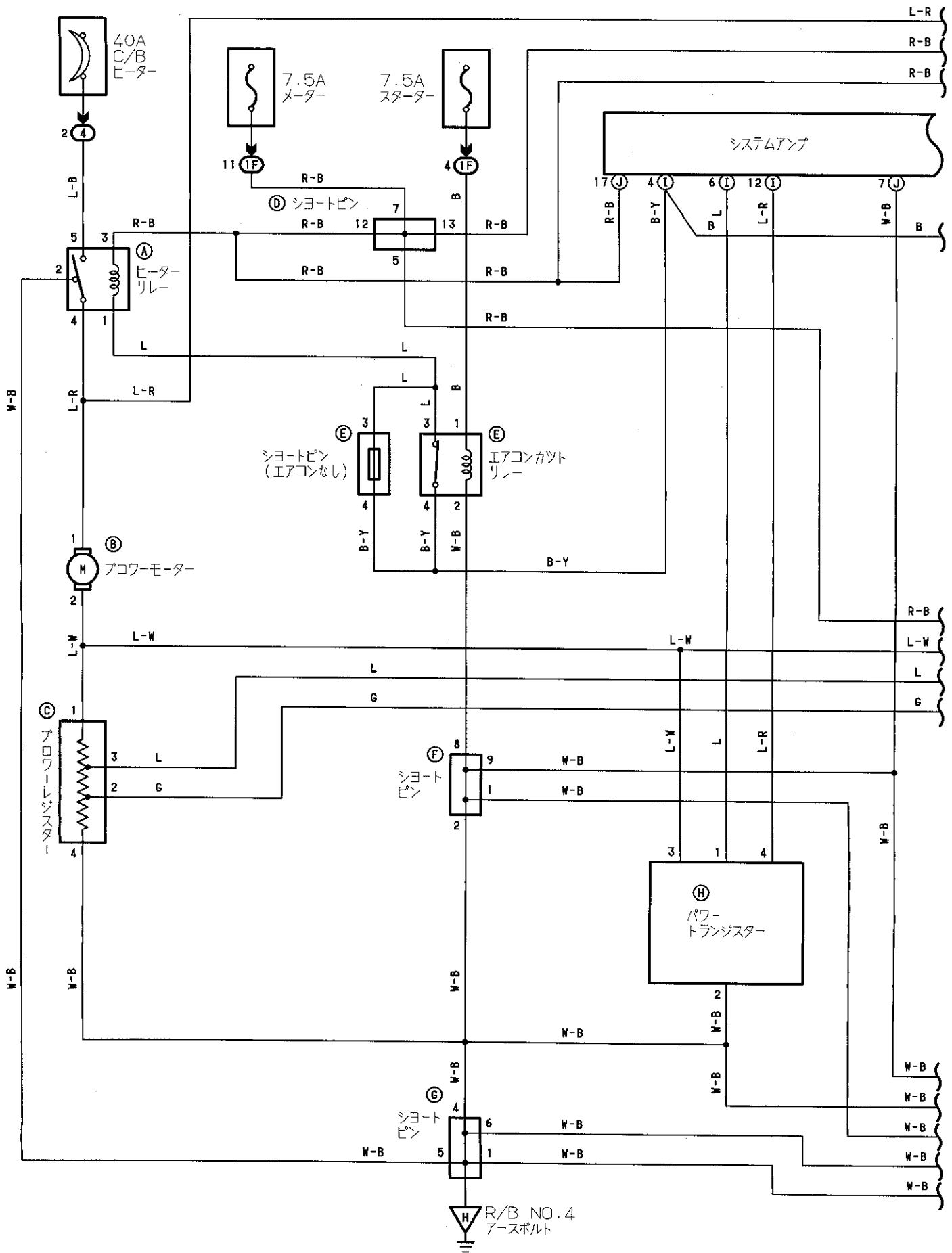

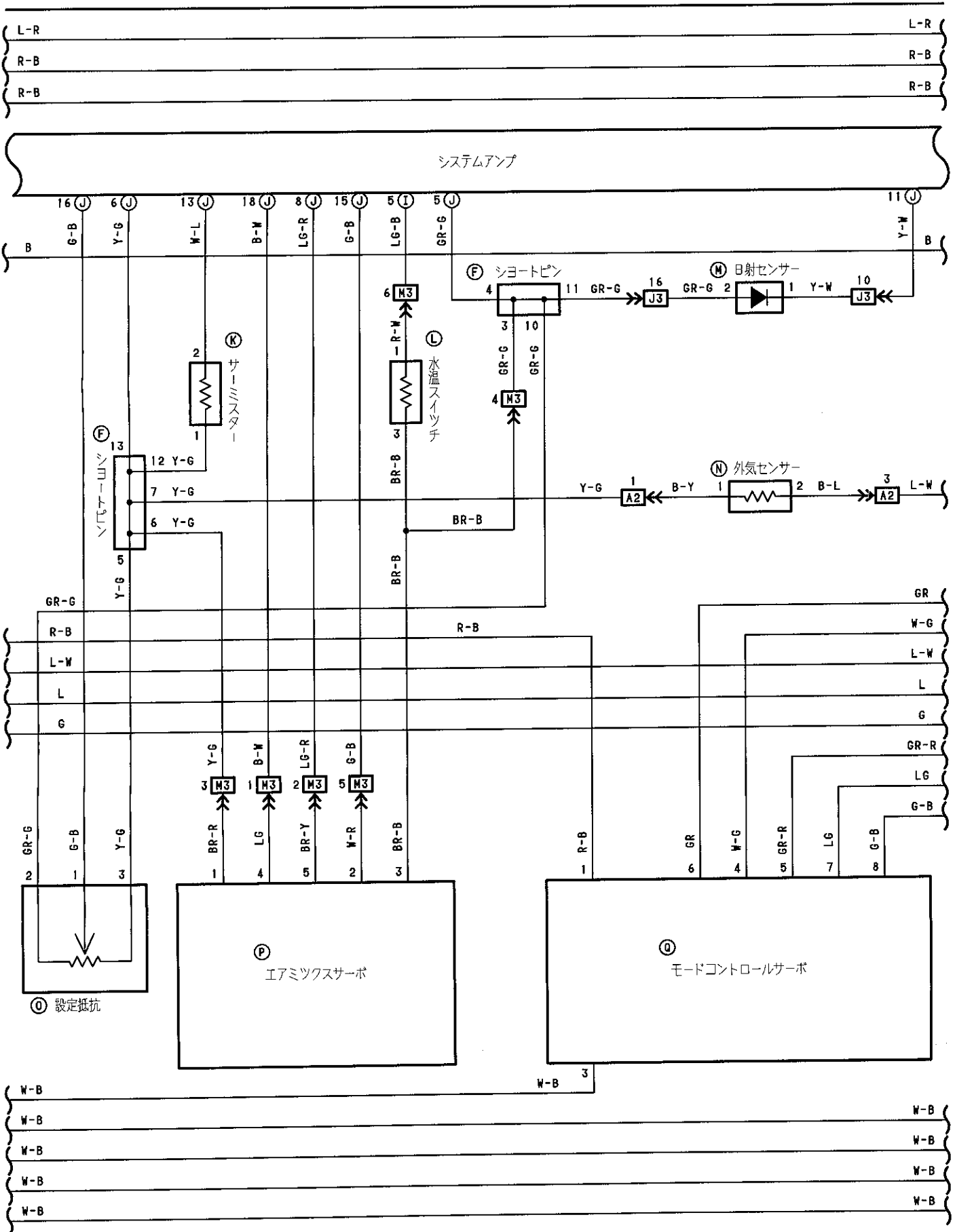



# オートエアコンディショナー(2L-T)

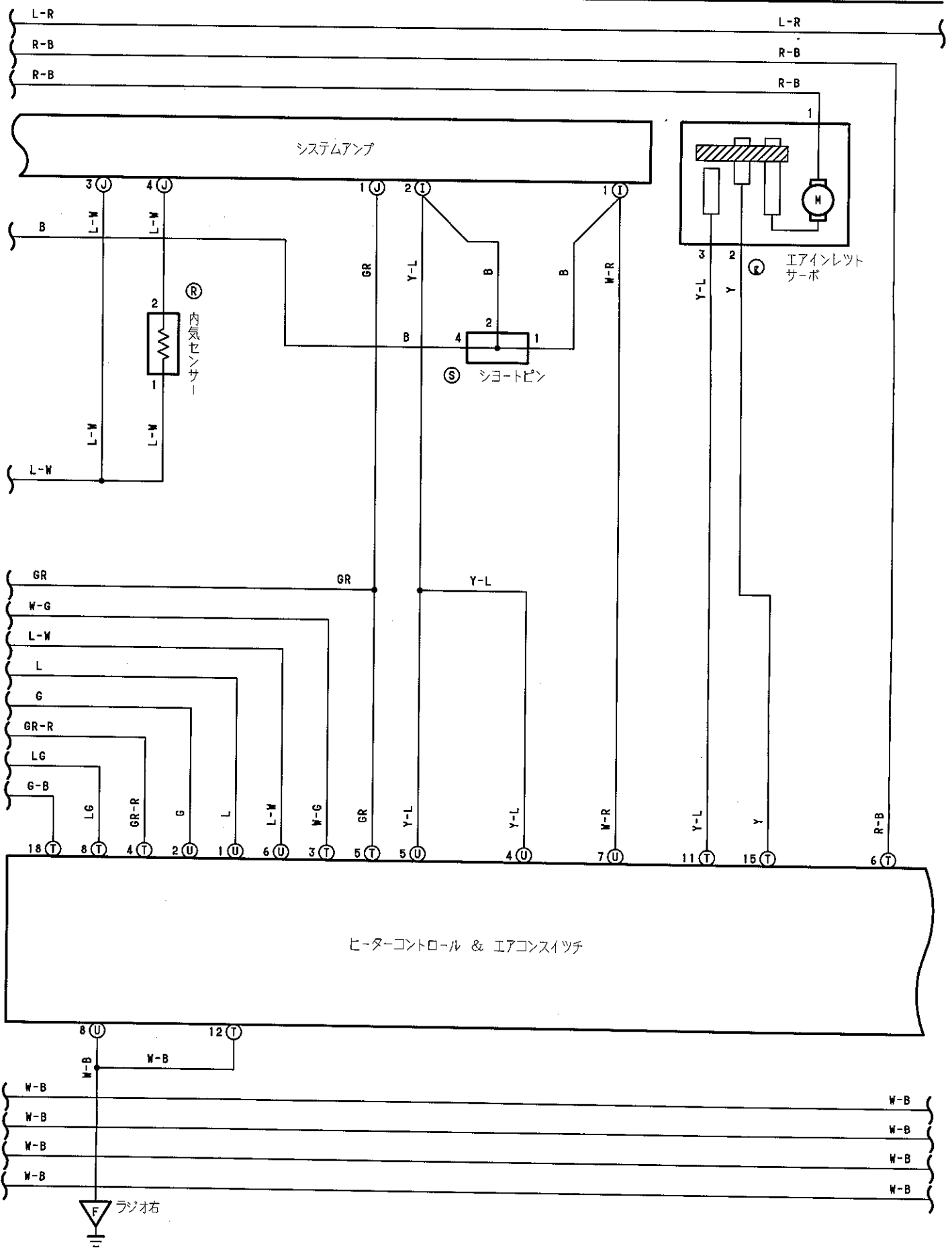





# オートエアコンディショナー(2L-T)

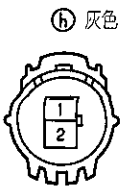
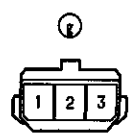
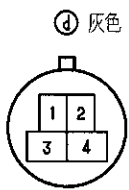
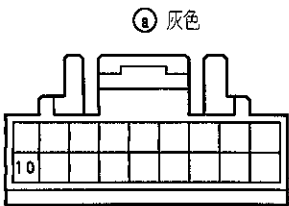
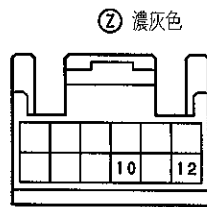
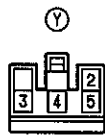
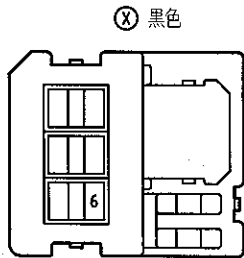
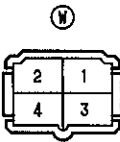
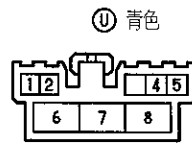
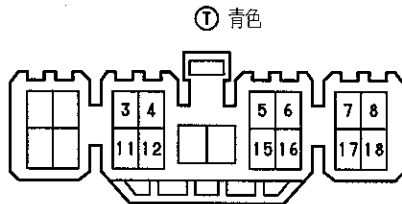
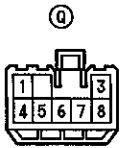
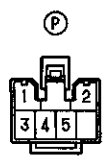
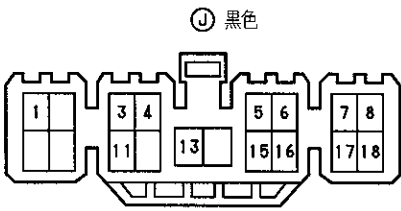
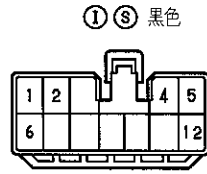
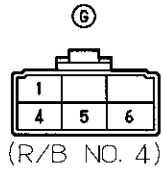
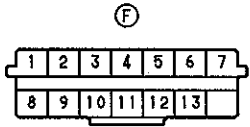
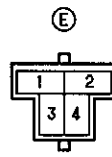
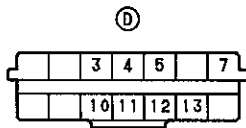
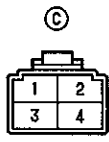
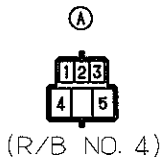

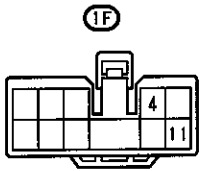

A2 灰色

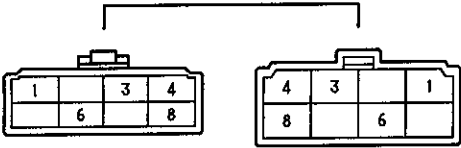

F1 濃灰色

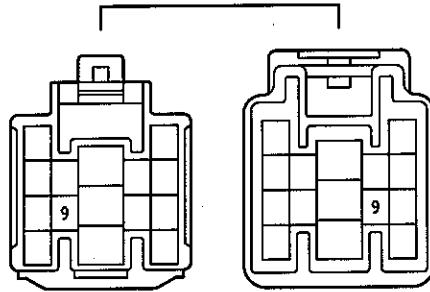

F2 濃灰色

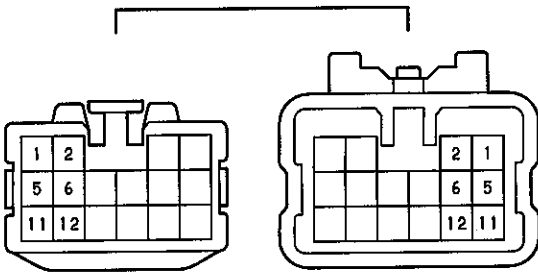

J3

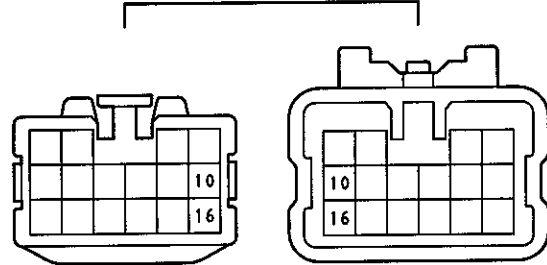

M1 M3

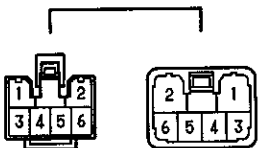



# エアコンディショナー (Q, V, Zグレード除く7M-GE)

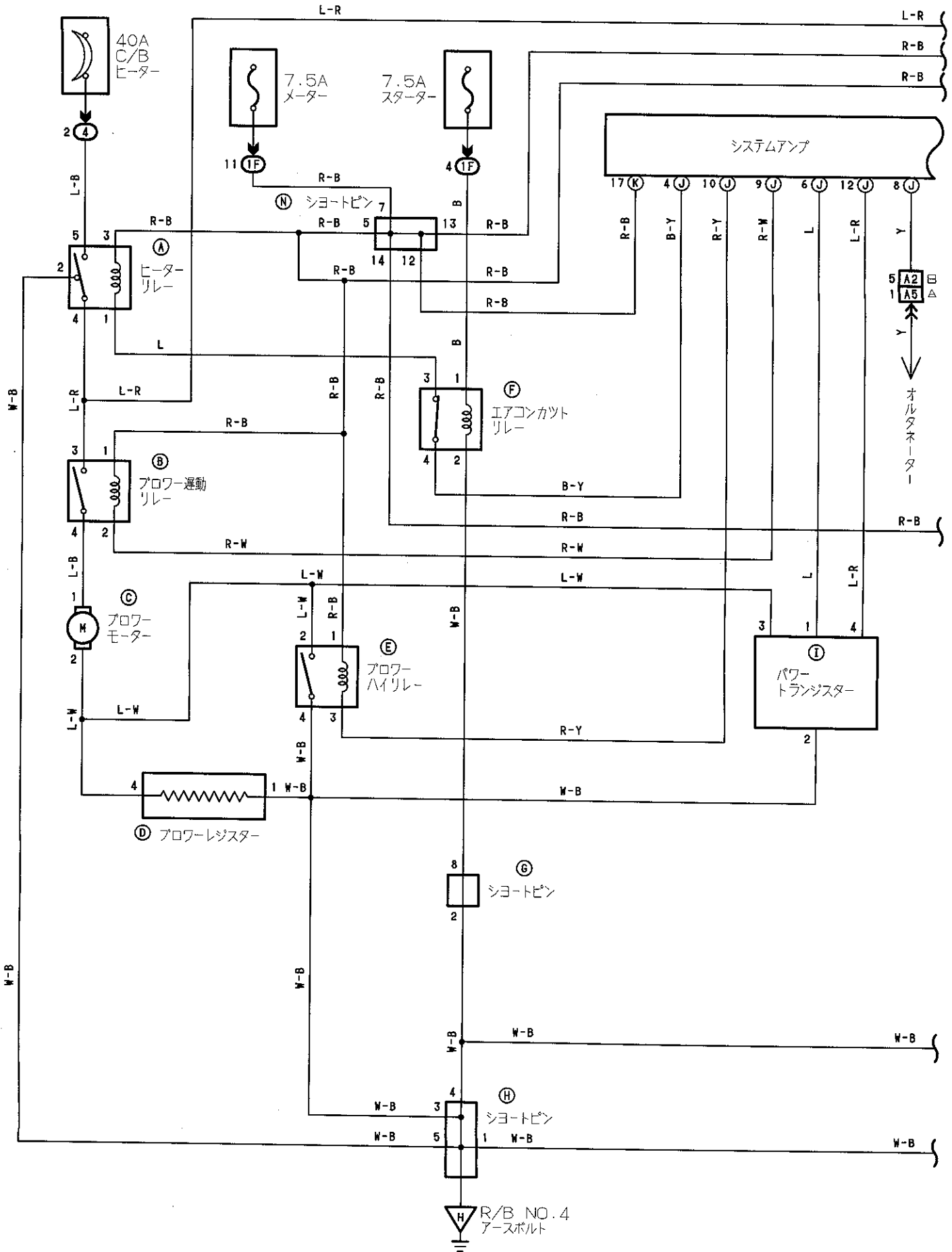

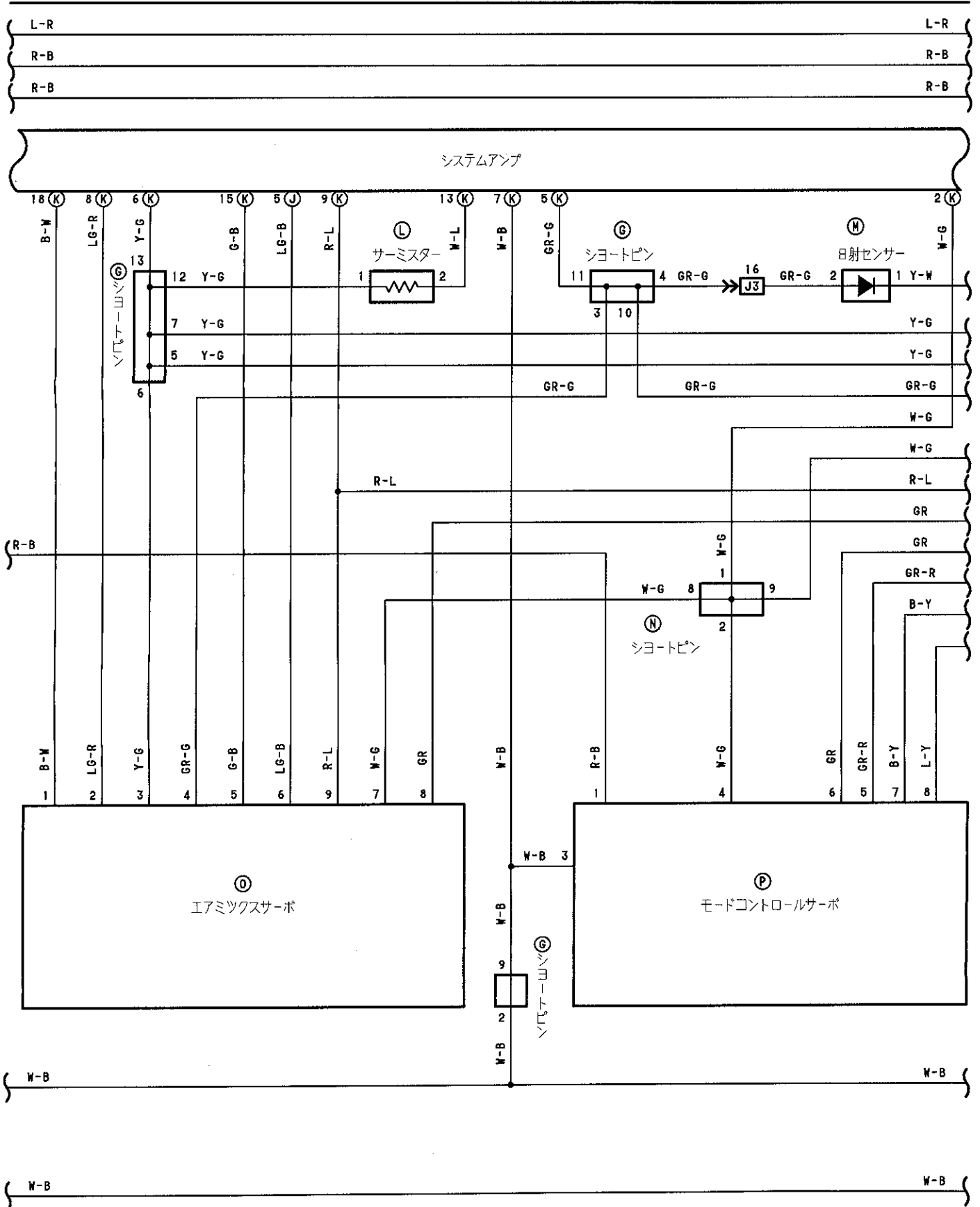

# エアコンディショナー (Q, V, Zグレード除く7M-GE)

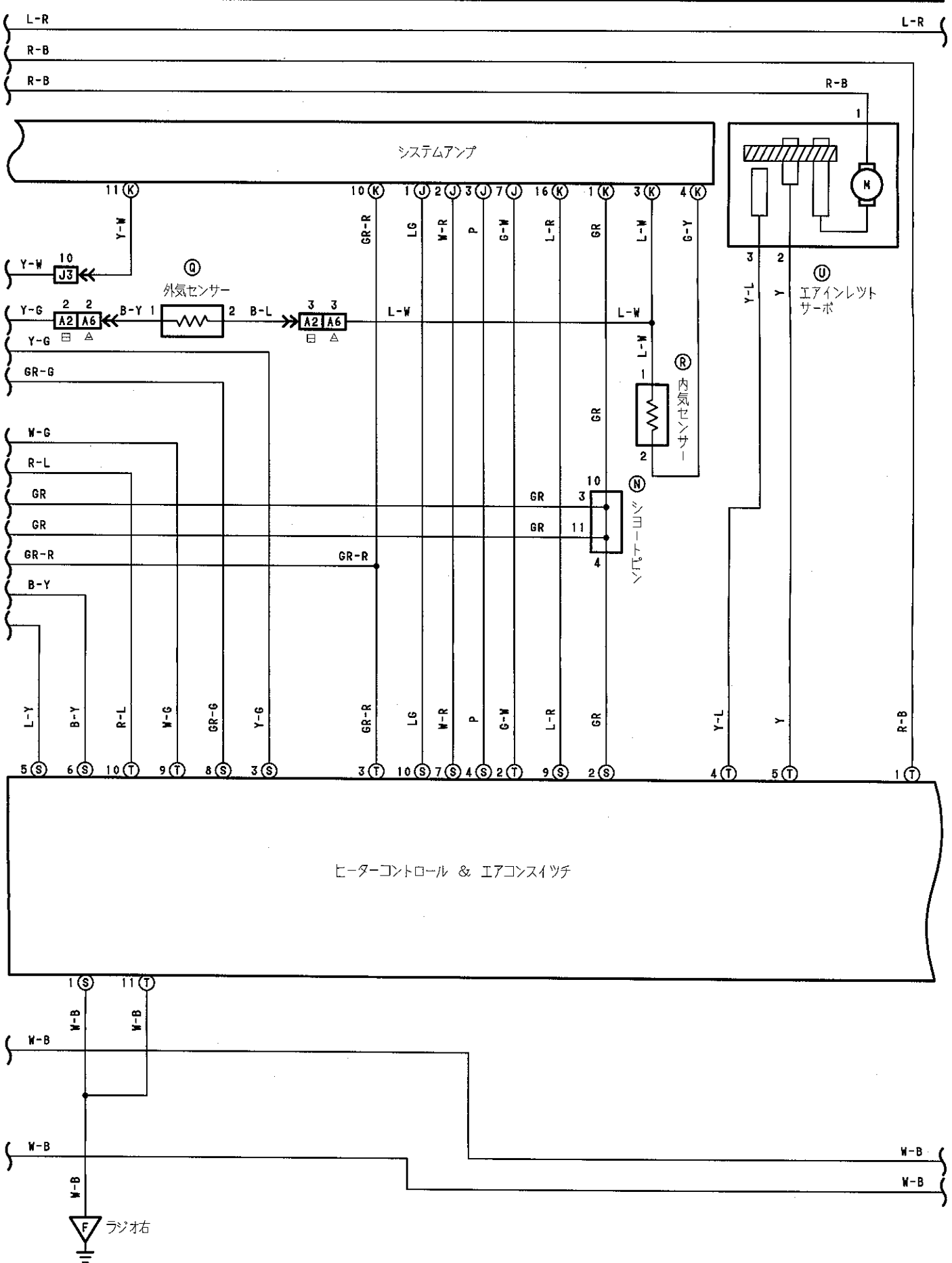

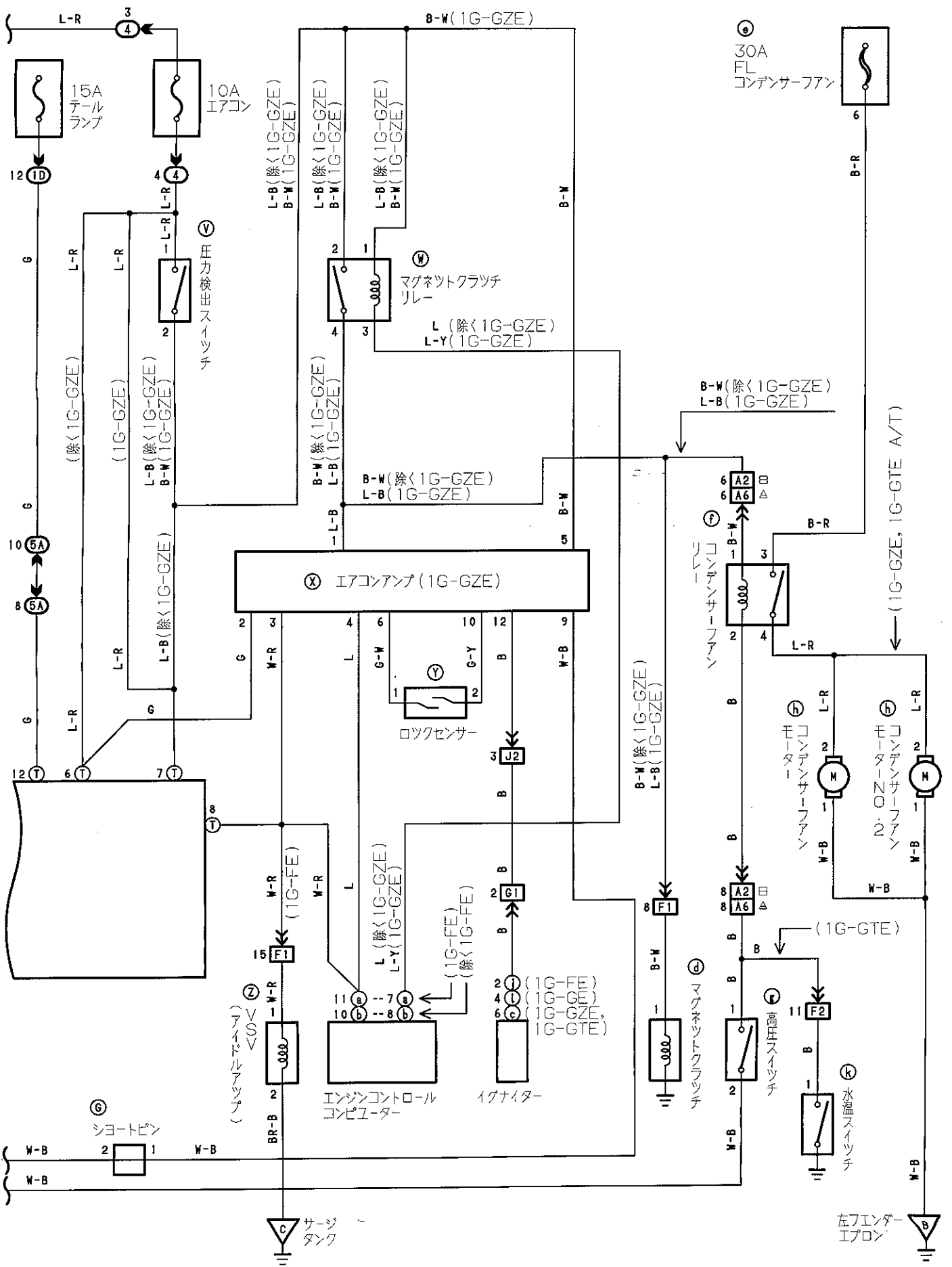



# エアコンデショナー (Q, V, Zグレード除く7M-GE)

(A)



(R/B NO.4)

(B)

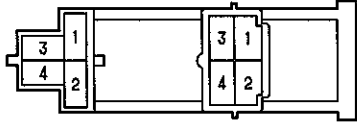

(E) 黒色

(C)

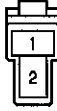

(D)



(F)

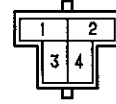

(G) (N)

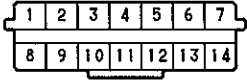

(H)

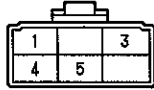

(R/B NO.4)

(I) 黒色



(J) 黒色

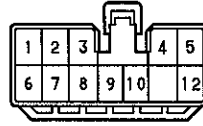

(K) 黒色

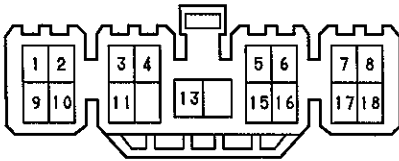

(L)

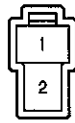

(M)



(O)

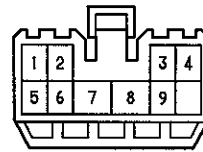

(P)



(Q) 黒色



(R) 青色



(S) 青色

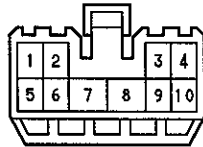

(T) 青色

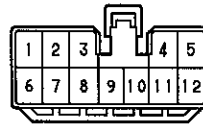

(U)



(V) 灰色



(W)

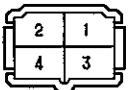

(X)

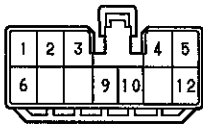

(Y) 青色



(Z) 灰色



(a) 濃灰色

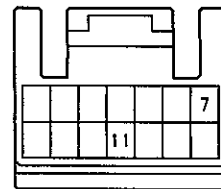

(b) 濃灰色

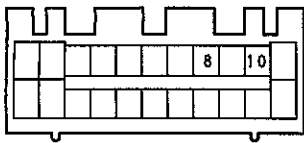

(c) 濃灰色

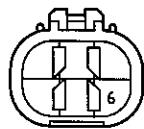

(d) 灰色



(e) 黒色

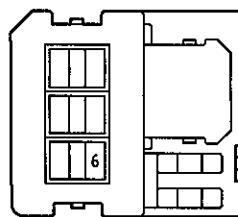

(f) 灰色

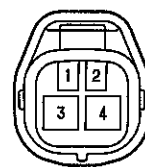

(g) 黒色



(h) 黒色



(i) 黒色



(j) 濃灰色



(k) 青色



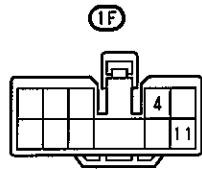
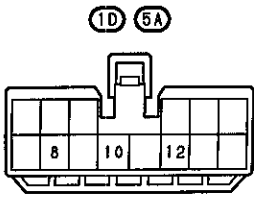

**A2** 灰色



**A5** 灰色

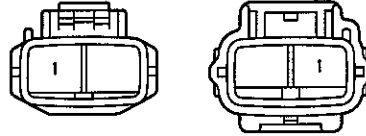

**A6** 灰色

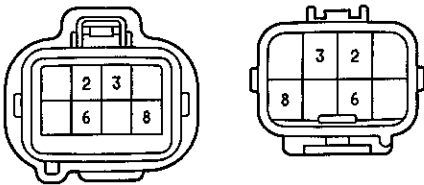

**F1** 濃灰色

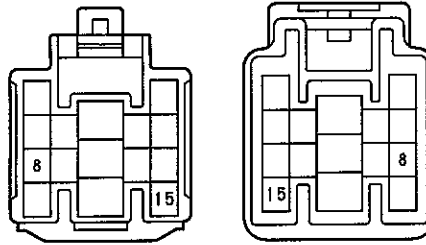

**F2** 濃灰色

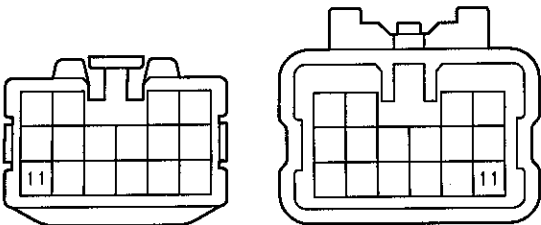

**G1**

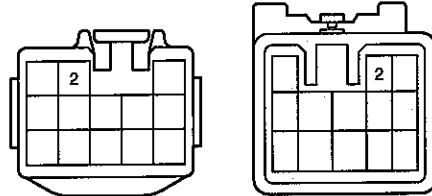

**J2**



**J3**

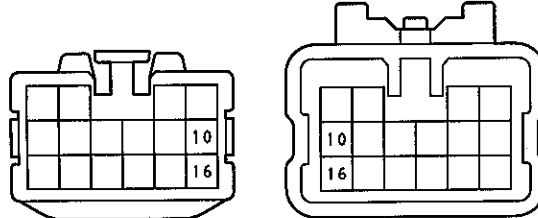



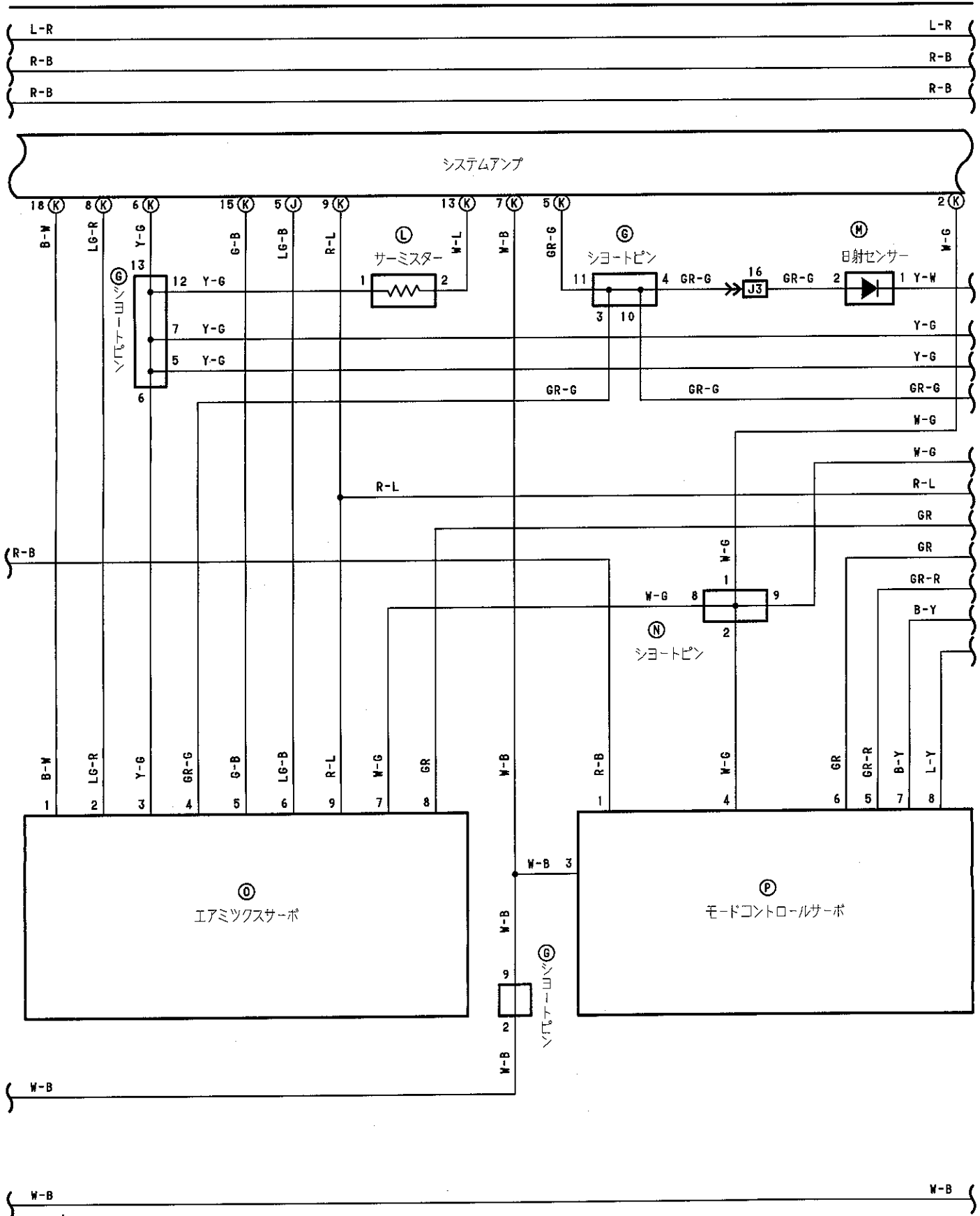

# エアコンディショナー (7M-GE)

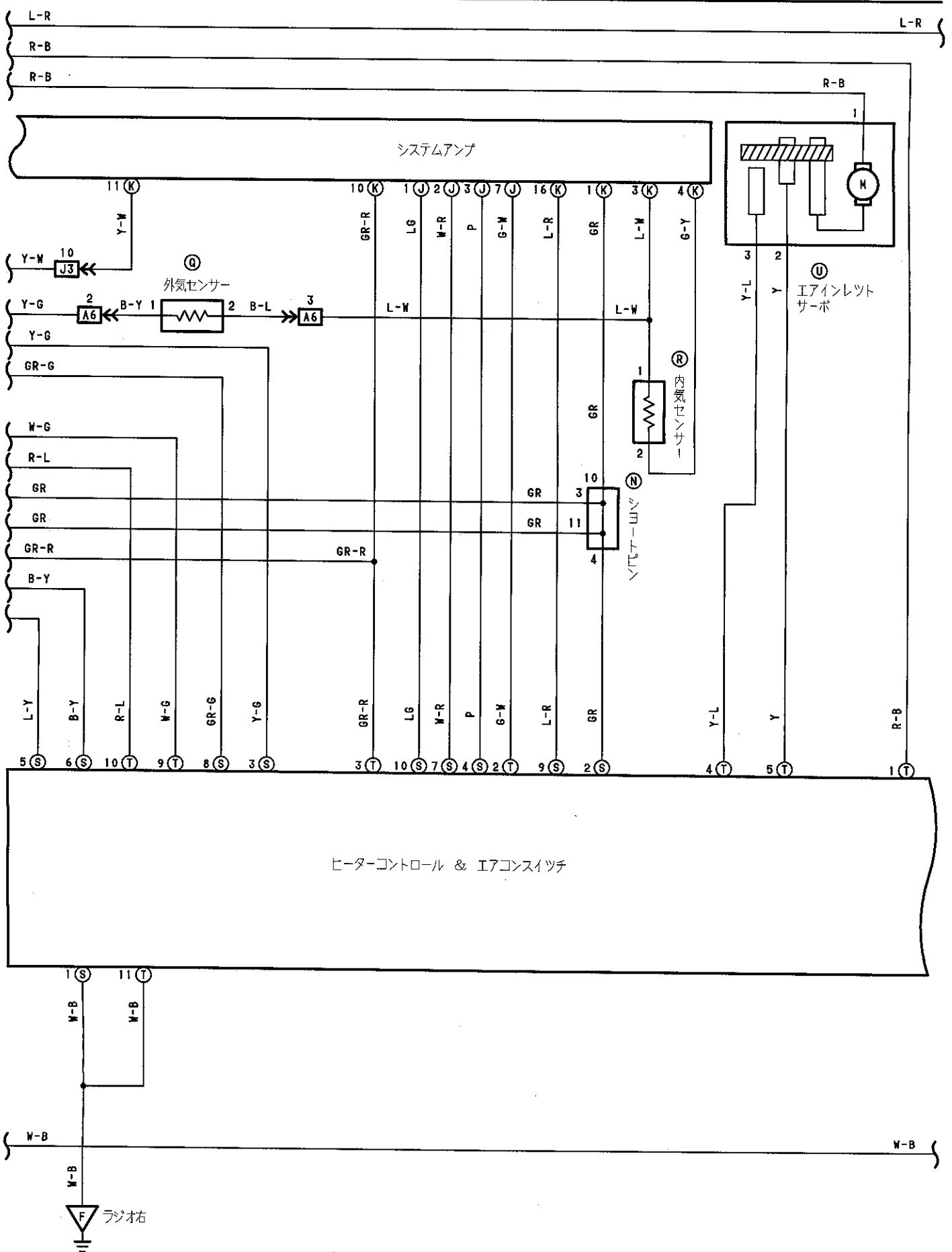



# エアコンディショナー (7M-GE)

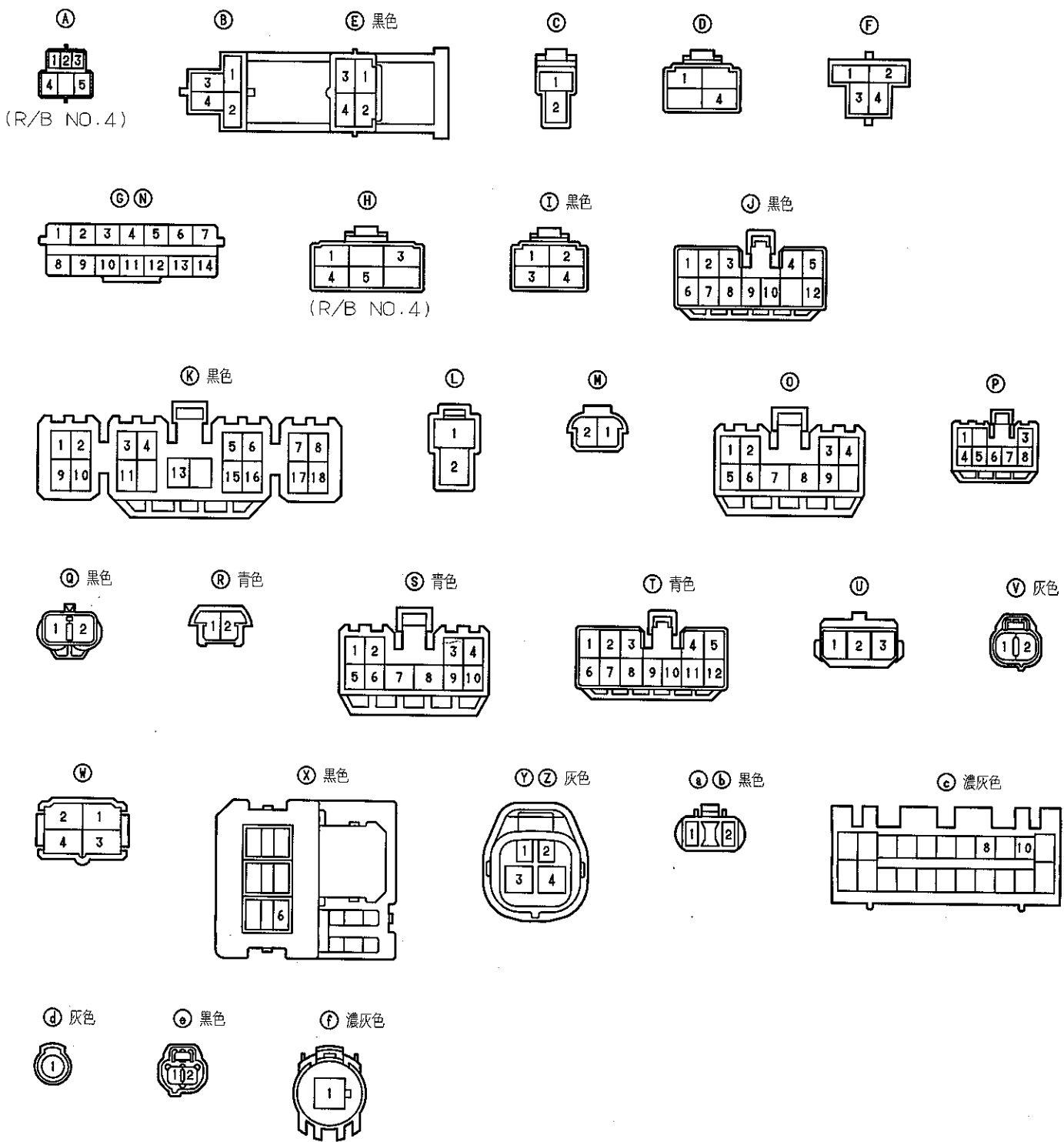

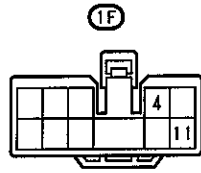
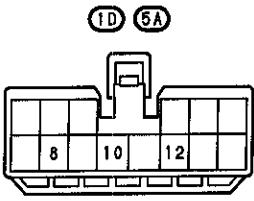

①A5 灰色

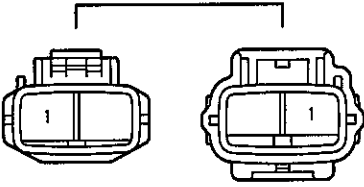

①A6 ①A8 灰色

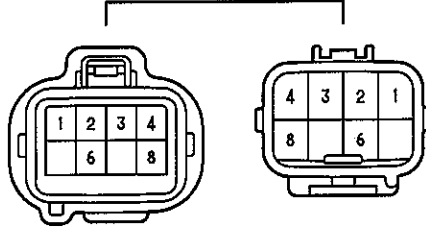

①F1 濃灰色

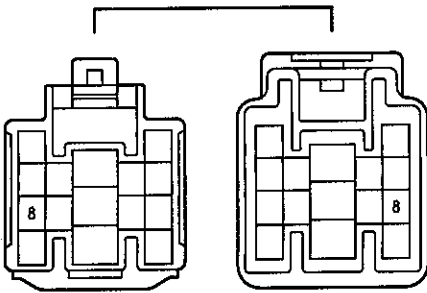

①F4 濃灰色

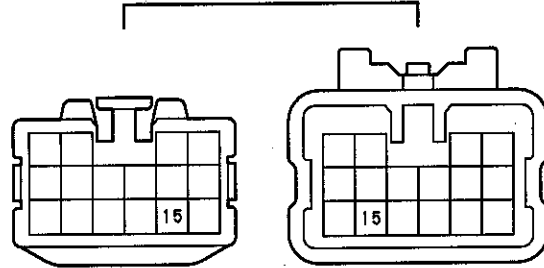

①J3

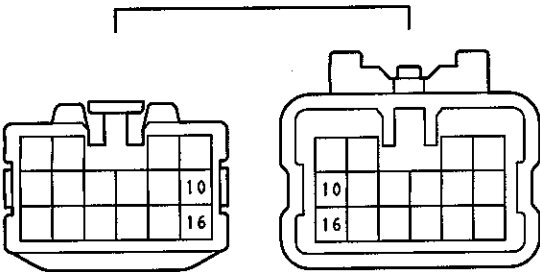

# アースポイント

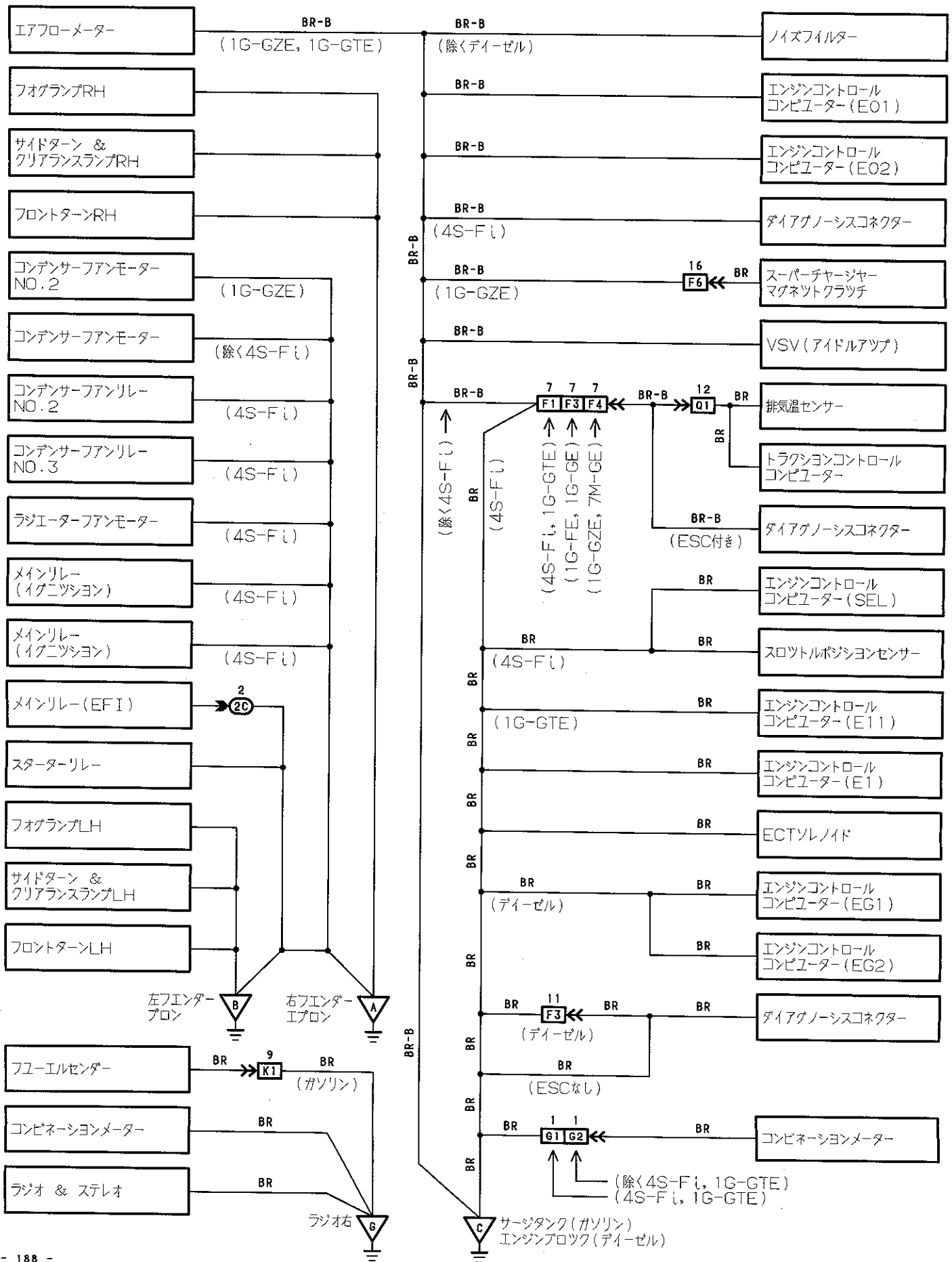

J/B NO. 3

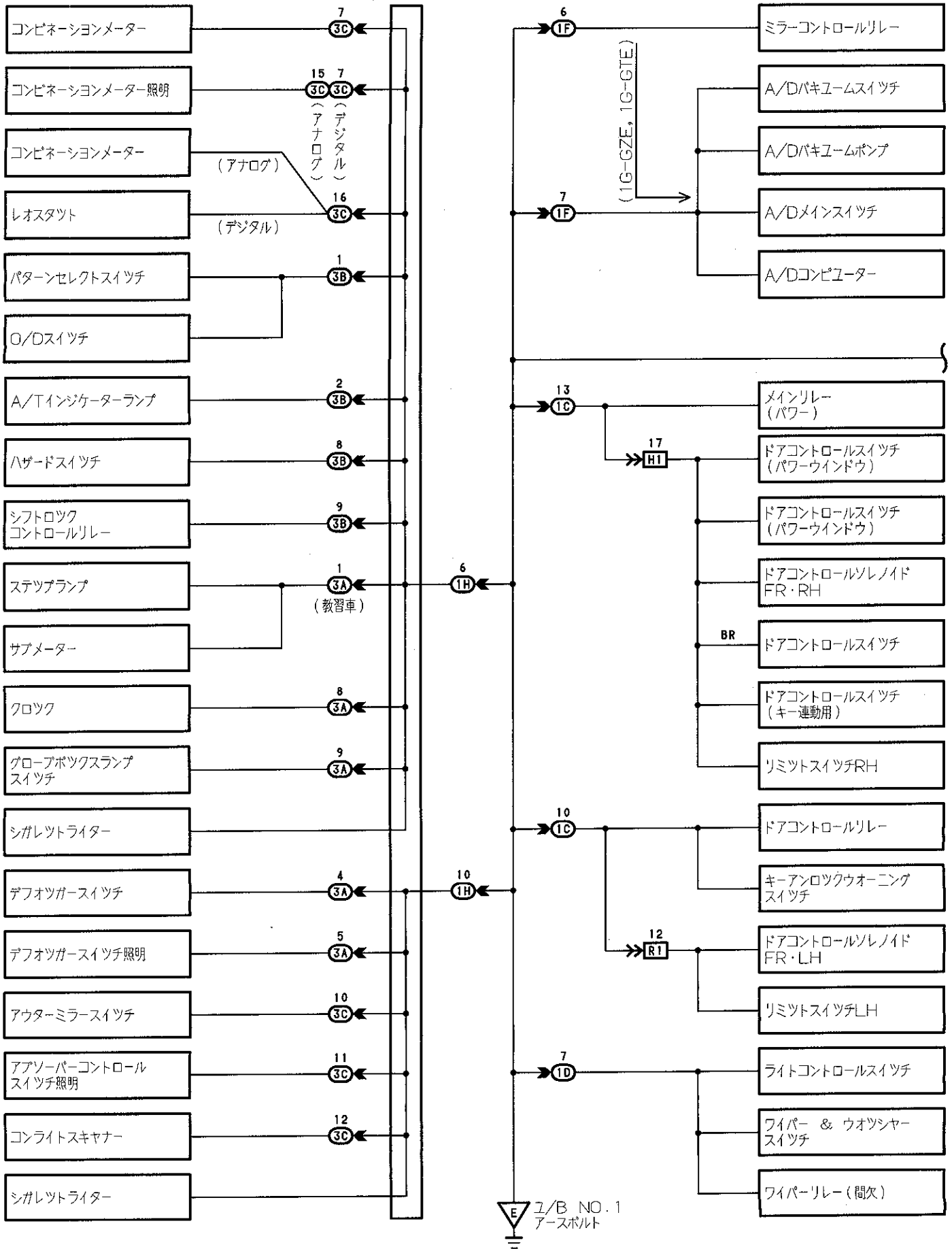

# アースポイント

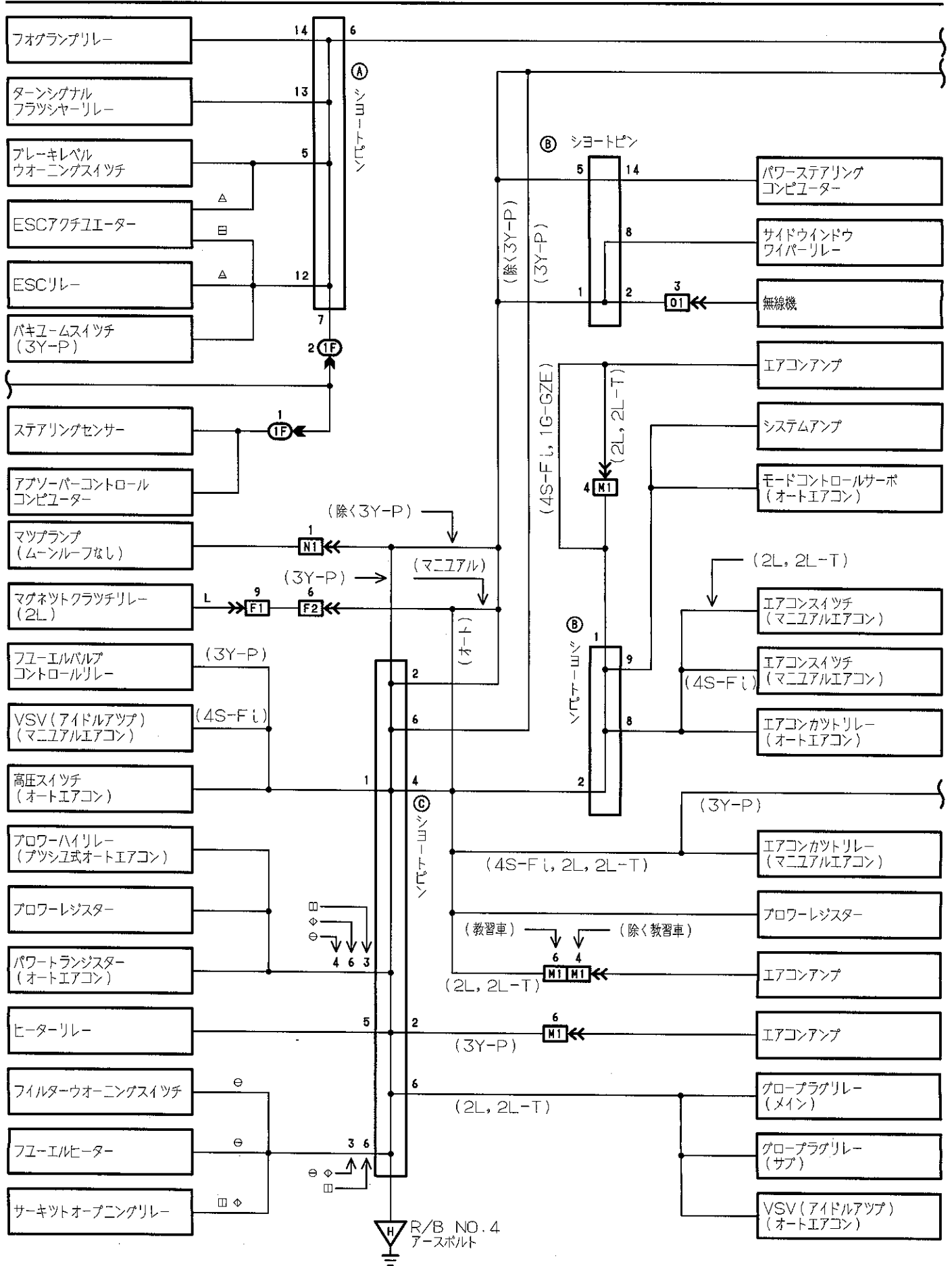

- ◇ 4S-FI
- トラクションコントロールなし
- △ トラクションコントロール付き
- 1G-FE, 1G-GE, 1G-GZE, 1G-GTE
- 2L, 2L-T

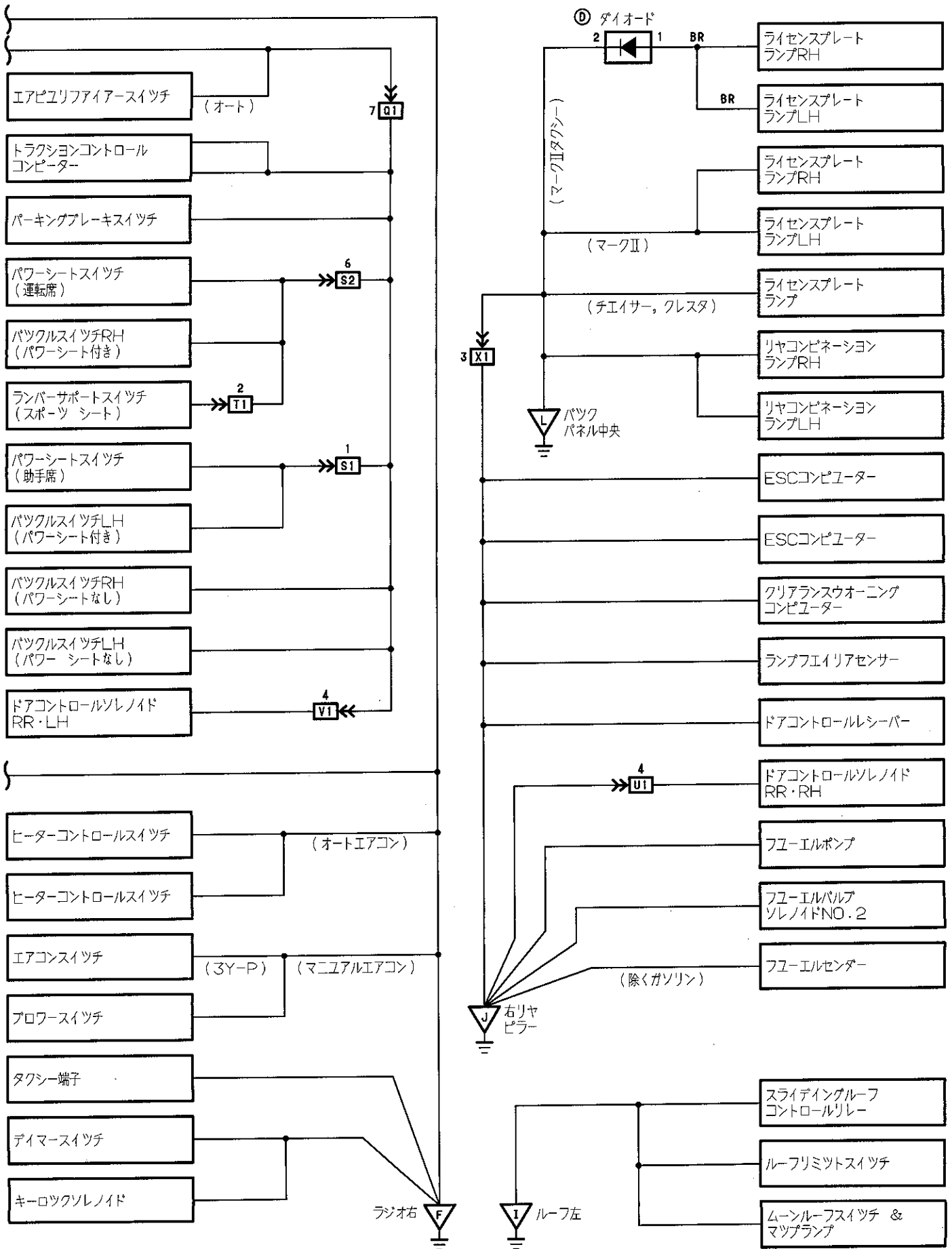

# ≡ アースポイント

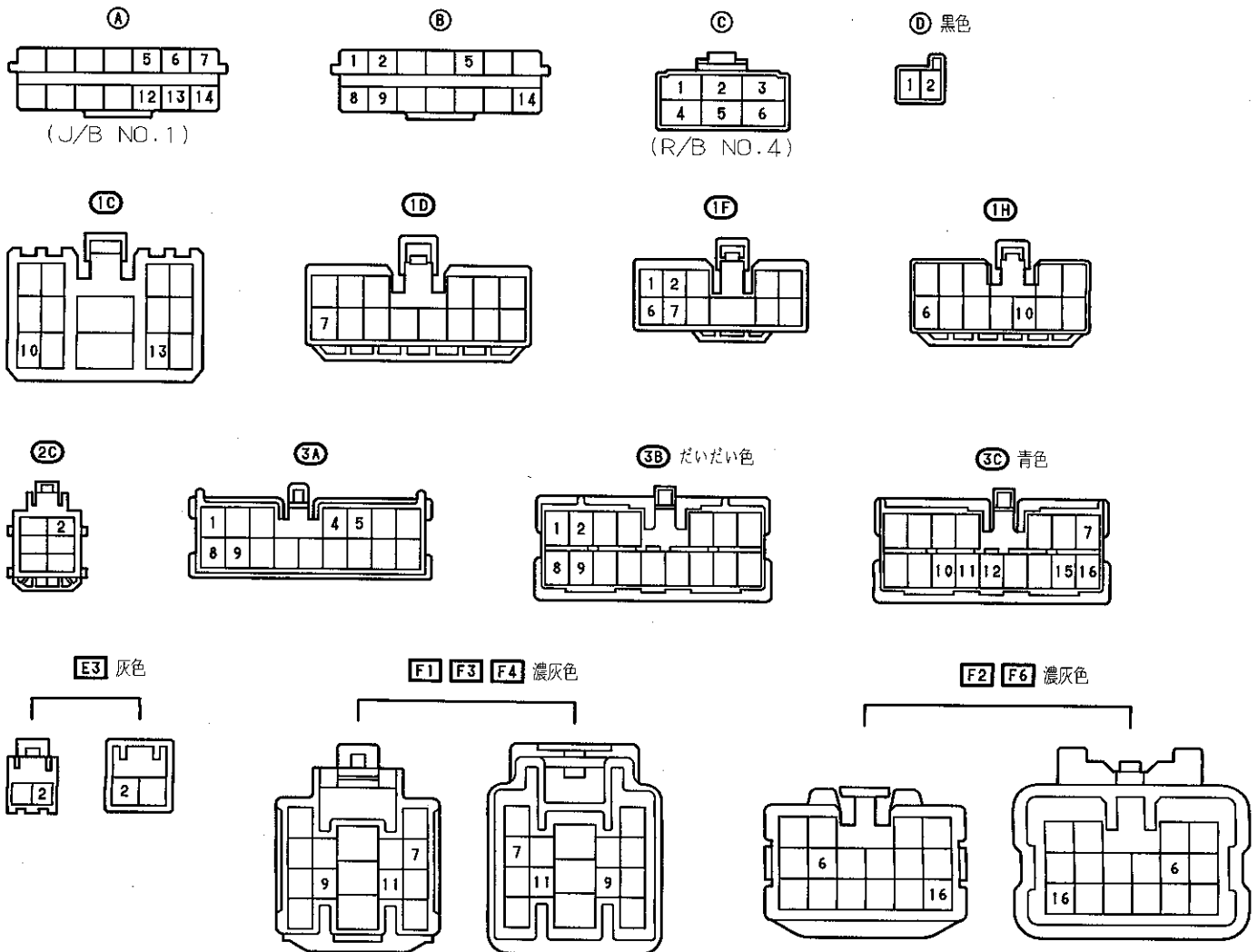
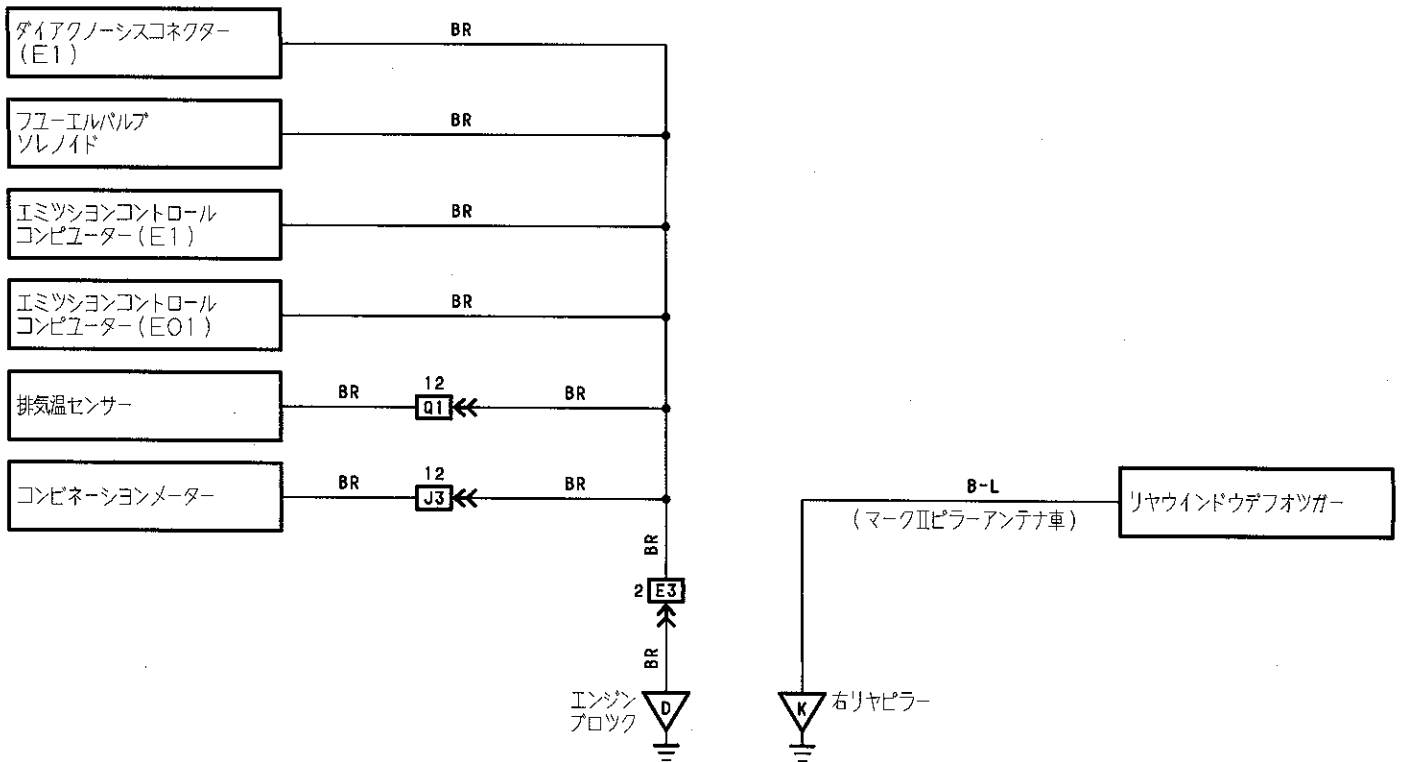

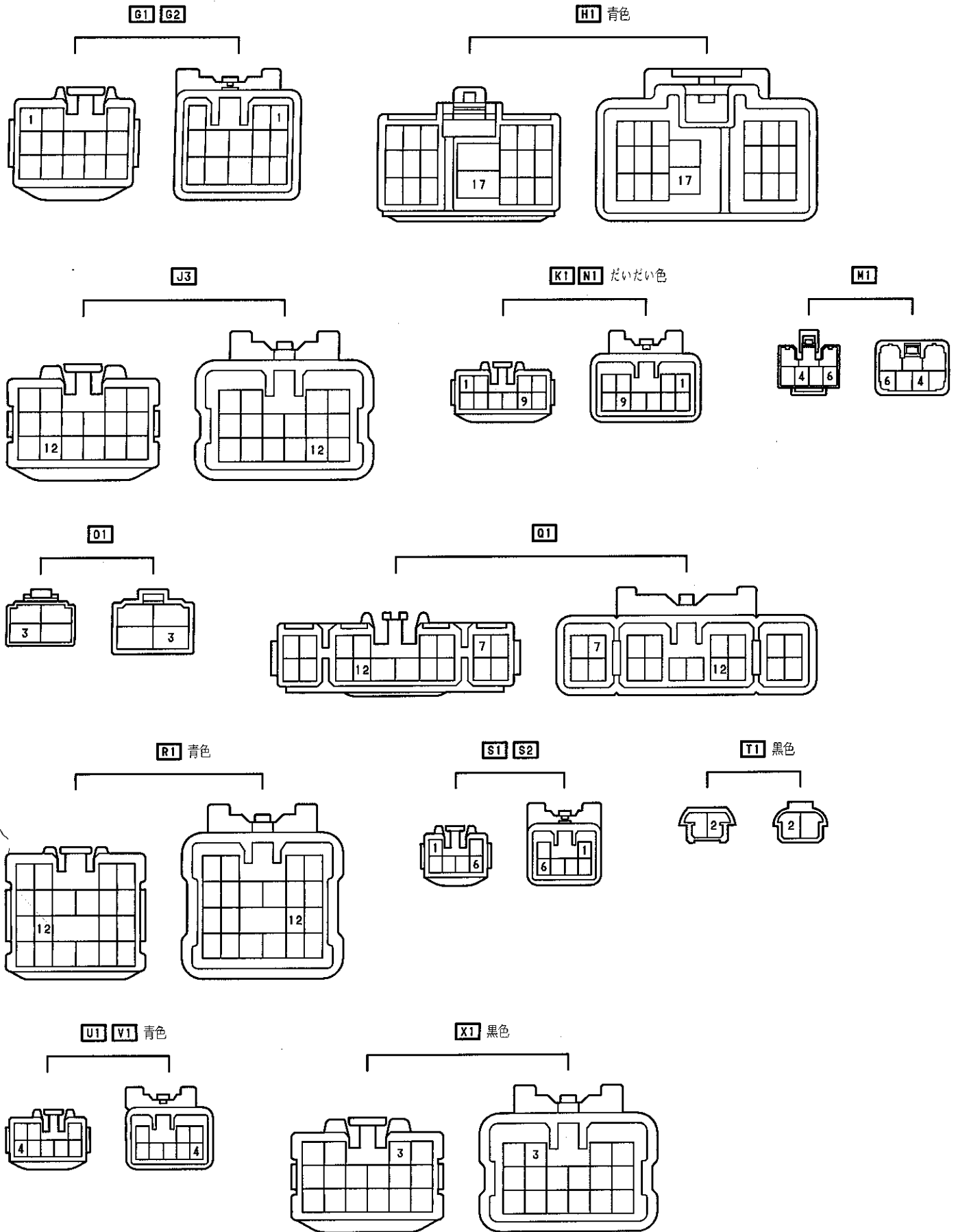

---

MEMO