

2 システム別配線図

電源回路

ヒューズ-負荷	2-2
電源回路	2-8

システム回路

エンジン関係

スターティング & イグニッション(ガソリン)	2-10
スターティング & イグニッション(除くガソリン)	2-16
キャブレター(3Y-P)	2-19
充電(ガソリン)	2-20
充電(除くガソリン)	2-22
アイドルアップ(4S-FE)	2-24
アイドルアップ(7M-GE)	2-25
フューエルヒーター	2-26
EFI(4S-FE)	2-28
EFI(1G-FE)	2-32
EFI(1G-GE)	2-38
EFI(1JZ-GE)	2-44
EFI(1JZ-GTE)	2-50
EFI(7M-GE)	2-54
EGR(2L, 2L-T)	2-60
排出ガス浄化装置(3Y-P)	2-64
油圧クーリングファン(1JZ-GTE)	2-172

シャシ関係

パワーステアリング	2-108
ECT(1G-GE, 1JZ-GE, 1JZ-GTE, 7M-GE)	2-126
シフトロック	2-133
オーバードライブ	2-134
トラクションコントロール	2-136
TEMS	2-140
ABS(トラクションコントロールなし)	2-144
ABS(トラクションコントロール付き)	2-148

ボデー関係

タクシー用端子	2-27
クリアランスソナー	2-88
フロントワイパーデアイサー	2-95
リヤウインドウデフォグ	2-96
超音波雨滴除去ミラー	2-98
フロントワイパー & ウォッシャー	2-100
リヤワイパー & ウォッシャー	2-102
サイドウインドウワイパー & ウォッシャー	2-104
テンションリデューサー(Qグレード以上)	2-106
パワーシート(運転席)	2-110
パワーシート(助手席)	2-112
ランバーサポート	2-114
パワーウインドウ	2-116

ドアロック	2-120
ムーンルーフ	2-124
電動ミラー	2-130

インストルメントパネル廻り

トランスミッションインジケータ	2-129
シガレットライター & クロック	2-156
ラジオ & ステレオ(6スピーカー)	2-158
CDオートチェンジャー	2-160
コンビネーションメーター(アナログ)	2-164
コンビネーションメーター(デジタル)	2-168

灯火類

ヘッドランプ	2-66
コンライト	2-68
テールランプ	2-70
イルミネーション	2-72
インテリアランプ	2-76
ストップランプ	2-80
フォグラмп	2-81
バックアップランプ	2-82
コーナーリングランプ	2-84
リヤライトウォーニング	2-86
ターンシグナル & ハザード	2-92

空調関係

マニュアルエアコンディショナー	2-174
オートエアコンディショナー	2-185

その他

オートドライブ	2-152
ホーン	2-157
テレフォン	2-163

アースポイント

アースポイント	2-216
---------	-------

2

J/B NO.1 (右カウルサイド)

電 源		負 荷	ページ
7.5A	ラジオ	リモートコントロールアクチュエーター, ミラーコントロールリレー(格納式)	2-130
		クロック	2-156
		ラジオ & ステレオ	2-158
15A	シガレットライター	シフトロックコントロールリレー	2-133
		無線機	2-162
		システムアンプ	2-204, 210
15A	エンジン	オルタネーター(ICレギュレーター付き)	2-20, 22
7.5A	イグニッション	フューエルバルブソレノイド	2-19
		チャージウォーニングランプ	2-20, 22
		フューエルヒーターリレー	2-26
		メインリレー(EFI)	2-28
		エンジンコントロールコンピューター	2-32, 38, 44, 50, 54, 126
		エミッションコントロールコンピューター, VSV(フューエルカット), インジェクター, ダイアグノーシスコネクター	2-64
		コンビネーションメーター, 補助スピードメーター(教習車教官用)	2-165
		コンビネーションメーター	2-169
		コンデンサーファンリレー, クーリングファンコンピューター	2-172
		ラジエーターファンリレーNo.1, メインリレー	2-174, 188
7.5A	スターター	コンデンサーファンリレーNo.2	2-189
		コールドスタートインジェクター, スタートインジェクタータイムスイッチ	2-10
		サーキットオープニングリレー	2-28
		サーキットオープニングリレー, エンジンコントロールコンピューター	2-32, 38, 44, 50, 54
		スターターソレノイド	2-64
		コンビネーションメーター	2-168
20A	ワイパー	エアコンカトリレー	2-176, 179, 183, 185, 192, 198
		ワイパーモーター, ウォッシャーモーター, ウィンドウシールドワイパーリレー, ワイパー & ウォッシャースイッチ	2-100
		リヤワイパーモーター & リレー, ウォッシャーチェンジバルブ, ウォッシャーモーター	2-102
		サイドウィンドウウォッシャーモーター, サイドウィンドウワイパーリレー	2-104
15A	エレクトロニクス B	タクシー端子(料金メーター)	2-27
		コンライトスキャナー	2-68
		ミラーコントロールリレー(格納式)	2-131
		トランスミッションコントロールコンピューター	2-136
		ABSコンピューター	2-145, 149
15A	エレクトロニクス IG	タクシー端子(料金メーター), タクシー端子(タコグラフ)	2-27
		コンライトスキャナー	2-68
		クリアランスウォーニングディスプレイ	2-89
		パワーステアリングコンピューター	2-108
		ドアコントロールリレー	2-116, 120, 124
		スライディングルーフコントロールリレー	2-214
		シフトロックコントロールリレー	2-133
		トランスミッションコントロールコンピューター	2-136
		ステアリングセンサー, インジケーターランプ, アブソーパーコントロールコンピューター	2-140
		ABSコンピューター	2-145, 149
		A/Dコンピューター	2-152
		無線機	2-162
ラジエーターファンリレー	2-213		

電 源		負 荷	ページ
7.5A	ターン	コーナリングランプリレー, コーナリングランプ	2-84
		ターンシグナルフラッシャー, ターンシグナルランプ, ターンシグナルインジケータランプ	2-92
15A	ストップランプ	エンジンコントロールコンピューター	2-29, 34, 41, 47, 51, 57
		ノイズフィルター, ランプフェイリアリレー, センターストップランプ, ストップランプ	2-80
		ランプフェイリアセンサー	2-86
		シフトロックコントロールリレー	2-133
		トランスミッションコントロールコンピューター	2-136
		アブソーパーコントロールコンピューター	2-141
		ABSコンピューター	2-145, 149
		A/Dコンピューター	2-153
15A	フォグランプ	フォグランプ	2-81
7.5A	メーター	排気温ウォーニングランプ, チェックエンジンウォーニングランプ	2-29, 34, 41, 47, 51, 57
		ターボ	2-51
		グローインジケータランプ, タコメーター	2-61
		排気温ランプ	2-64
		レオスタット	2-73, 169
		バックアップランプ	2-82
		ランプフェイリアセンサー, ランプフェイリアウォーニングランプ	2-86
		クリアランスウォーニングコンピューター	2-88
		デアイサーリレー, デアイサースイッチ	2-95
		インテグレーションリレー	2-96
		ラップベルトソレノイド	2-106
		エンジンコントロールコンピューター, トランスミッションインジケータランプ	2-126
		トランスミッションインジケータランプ	2-129
		O/Dリレー, O/Dソレノイド, O/D OFFインジケータランプ	2-134
		TRC OFFインジケータランプ, TRCインジケータランプ, トラクションコントロールコンピューター	2-137
		ABSコンピューター	2-144
		ABSインジケータランプ, ブレーキウォーニングランプ	2-144, 148
		A/Dインジケータランプ	2-152
		ブレーキウォーニングコンピューター, スピードセンサー	2-164
		コンビネーションメーター	2-164, 169
		スピードセンサー	2-168
		ヒーターリレー	2-176, 179, 183, 185, 192, 198
		モードコントロールサーボ, システムアンプ, エアインレットサーボ, ヒーターコントロール & エアコンスイッチ	2-185, 192, 198
ブロー遅動リレー, ブローハイリレー	2-204, 210		

電 源	負 荷	ページ	
15 A	テールランプ	タクシー端子(料金メーター), タクシー端子(タコグラフ)	2-27
		エンジンコントロールコンピューター	2-34, 41, 46
		クリアランスランプ, ランプフェイリアセンサー, テールランプ, ライセンスプレートランプ	2-70
		シガレットライター照明, グローボックスランプ, ステップランプ, サブメーター照明, A/Tインジケータランプ, パターンセレクトスイッチ照明, ワイパーデアイサースイッチ照明, ハザードスイッチ照明, コンビメーター照明, トランスミッションインジケータ照明, デフォッガースイッチ照明, アブソーパーコントロールスイッチ照明, ラジオ照明, エアピュリファイアスイッチ照明	2-72
		レオスタット	2-73, 169
		フォグランプリレー	2-81
		ランプフェイリアセンサー	2-86
		クリアランスウォーニングコンピューター	2-88
		クロック	2-156
		ヒーターコントロール & エアコンスイッチ	2-207, 213
		20 A	ミラー
20 A	シガレットライター	シガレットライター	2-156
30 A	ドアロック	ドアコントロールリレー	2-120
30 A	C/Bパワー	パワーシートモーター	2-110, 112
		ランバーサポートモーター	2-114
		ドアコントロールスイッチ, パワーウインドウモーター, パワーウインドウコントロールリレー	2-116
		メインリレー	2-120
		スライディングルーフコントロールリレー	2-124
30 A	C/Bデフォッガー	アイドルアップダイオード, ノイズフィルター, リヤウインドウデフォッガー, チョークコイル(ウインドシールドアンテナ車)	2-24, 96

J/B NO.2 (エンジンルーム)

15 A	ヘッドランプ(右)	アイドルアップダイオード	2-24, 25
		ダイオード(EFI)	2-54
		ヘッドランプ(RH)	2-66
15 A	ハザードホーン	ターンシグナルフラッシャー	2-92
		ホーン, ホーンリレー	2-157
15 A	ヘッドランプ(左)	ヘッドランプ(LH)	2-66
15 A	AM2	イグニッションスイッチ(AM2)	2-8
20 A	ルームランプ	エンジンコントロールコンピューター	2-61
		アップランプ, ルームランプ, ドアカーテシランプ, イグニッションキー照明, 半ドアウォーニングランプ, インテグレーションリレー, ラグジャーイルームランプ	2-76
		サイドウインドウワイパーリレー	2-104
		ドアコントロールレシーバー(ワイヤレスドアロック付)	2-120
		クロック	2-156
		ラジオ & ステレオ	2-158, 160
		コンビネーションメーター	2-168
20 A	EFI	エンジンコントロールコンピューター, サーキットオープニングリレー, フューエルポンプ, ダイアグノーシスコネクター, ISCV, VSV(T-VIS)(1G-GE, 1JZ-GE), VSV(7M-GE), VSV(エバポ)(1JZ-GE, 1JZ-GTE), O ₂ センサー(1JZ-GTE), フューエルポンプリレー(1JZ-GTE, 7M-GE), フューエルポンプレジスター(1JZ-GTE, 7M-GE)	2-28, 32, 38, 44, 50, 54
		エンジンコントロールコンピューター	2-126
20 A	フューエルヒーター	フューエルヒーター	2-26
15 A	テレフォン	無線機	2-162

R/B NO.4(左カウルサイド)

電 源		負 荷	ページ
10A	エアコン	ブローモーター	2-175, 188, 195, 201, 207
		ヒーターコントロール & エアコンスイッチ(除くマニュアルエアコン4S-FE), エアコンアンプ(4S-FE, 1JZ-GE, 1JZ-GTE), マグネットクラッチリレー, マグネットクラッチ & ロックセンサー(4S-FE, 1JZ-GE, 1JZ-GTE), コンデンサーファンリレーNo.3(4S-FE), マグネットクラッチ(1G-FEのGグレード, 1G-FE, 1G-GE, 7M-GE), コンデンサーリレー(1G-FEのGグレード, 1G-FE, 1G-GE, 7M-GE)	2-174, 188, 195, 201, 207, 213
		エアコンアンプ(除く教習車)(2L, 2L-T), エアコンサービスコネクター(教習車)(2L, 2L-T), エアコンサービスコネクター1(3Y-P), VSV(アイドルアップ), マグネットクラッチリレー, マグネットクラッチ, コンデンサーファンリレー(2L, 2L-T), コンデンサーファンリレー(教習車)(3Y-P)	2-178, 182
20A	フロントデアイサー	フロントワイパーデアイサー	2-95
40A	C/Bヒーター	ブローモーター, ヒューズエアコン	2-176, 179, 183, 185, 192, 198, 204, 210

ヒューズブルリンクボックス(エンジンルーム)

10A	アイドルアップファン	アイドルアップダイオード	2-174, 189
60A	ABS	ABSアクチュエーター	2-144
30A	ラジエーターファン	ラジエーターファンモーター, コンデンサーファンリレーNo.2	2-174, 189
80A	グロー	グロープラグレジスター, グロープラグカレントセンサー	2-60
100A	オルタ	C/Bデフォグガー, ヒューズストップランプ, ヒューズエレクトロニクスB, C/Bヒーター, ヒューズフロントデアイサー, ヒューズフォグランプ, ヒューズテールランプ, テールランプリレー, FL AM1, FLコンデンサーファン, FL ABS	2-8
		スターター	2-16
		オルタネーター(ICレギュレーター付き)	2-20, 22
		FLラジエーターファン, FLコンデンサーファン	2-174, 189
30A	コンデンサーファン	コンデンサーファンモーター	2-172, 174, 178, 182, 189, 195, 201, 207, 210
		ラジエーターファンモーター, コンデンサーファンモーター	2-213
40A	AM1	ドアロック, C/Bパワー, イグニッションスイッチ(AM1)	2-8
		スターター, ヒューズスターター, スターターリレー(除くガソリン車)	2-10, 16
		オルタネーター(ICレギュレーター付き)	2-20, 22
30A	AM2	イグニッションスイッチ(AM2)	2-8
		コンデンサー(ラジオ), イグニッションコイル, イグナイター, イグニッションコイル & イグナイター(1G-FE), コイル(1JZ-GTE), DLI(1JZ-GTE)	2-10
		IIA(3Y-P)	2-16
30A	トラクションコントロール	トラクションリレー	2-137

ヒューズブルリンク(バッテリー横)

2.0L 3.0W (注1)	メイン	FLオルタ, FL AM2, ヒューズAM2(ディーゼル), FLグロー(ディーゼル), ヒューズEFI, ヒューズルームランプ, ヒューズハザード・ホーン, ヒューズテレフォン, ヘッドランプリレー, ヒューズヘッドランプ(右), ヒューズヘッドランプ(左), ヒューズフューエルヒーター(ディーゼル)	2-8
----------------------	-----	---	-----

(注1) 2.0L : 3Y-P, 2Lタクシー 3.0W : 除く3Y-P, 2Lタクシー

MEMO

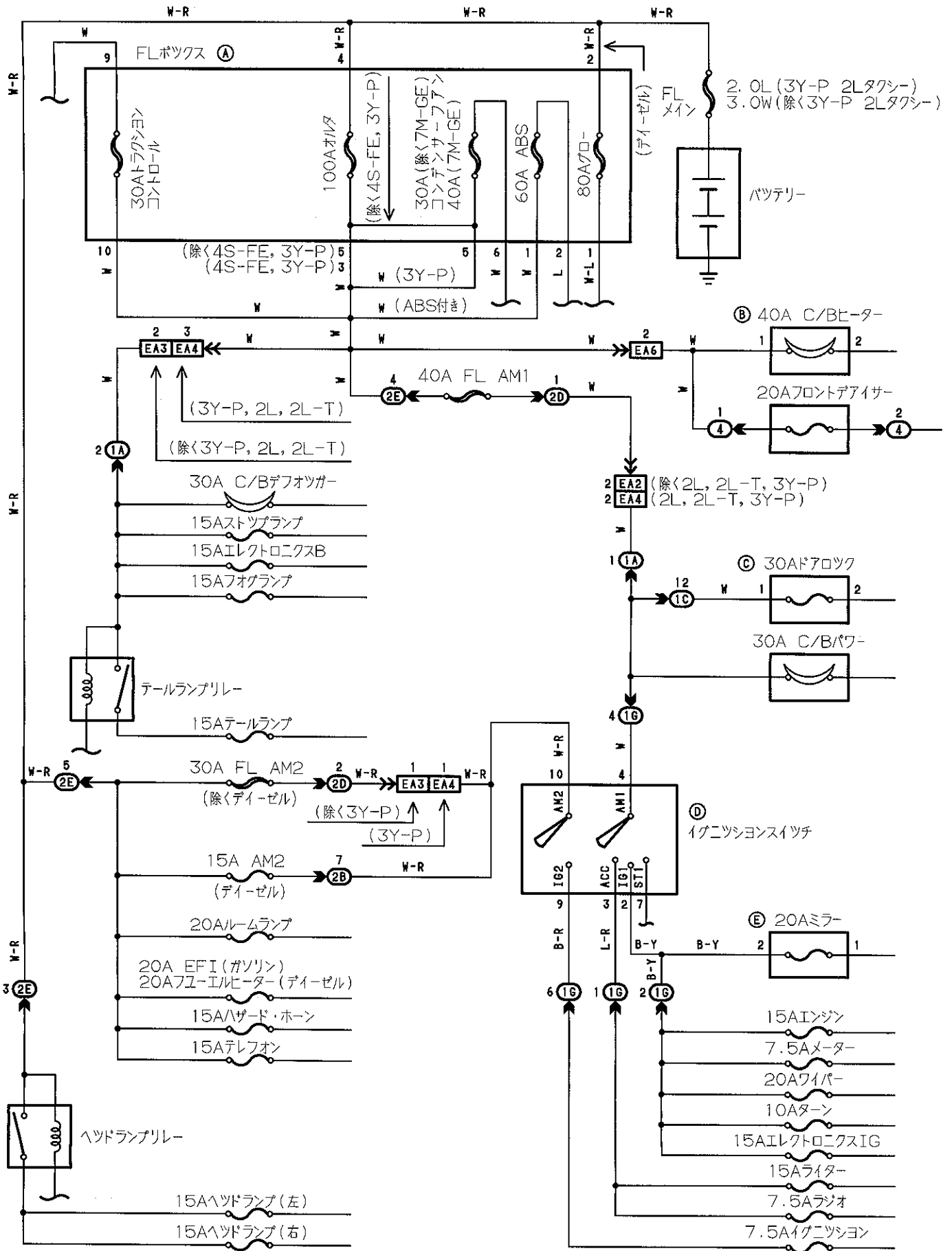

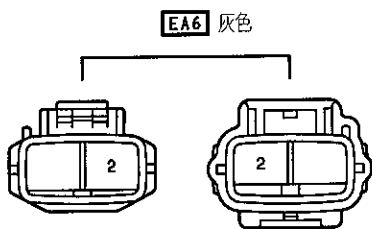
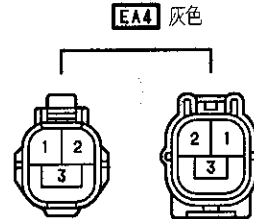
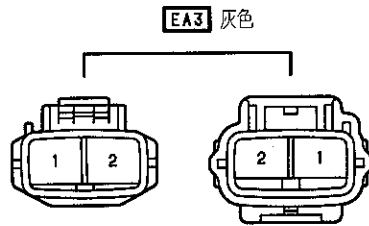
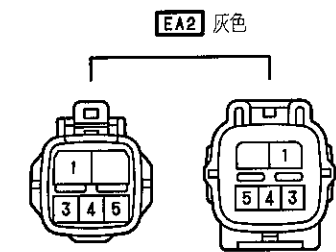
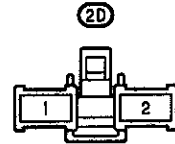
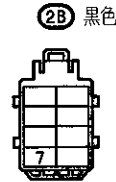
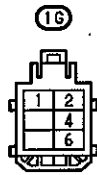
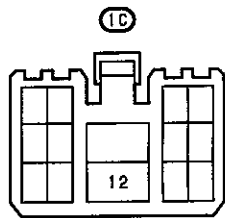
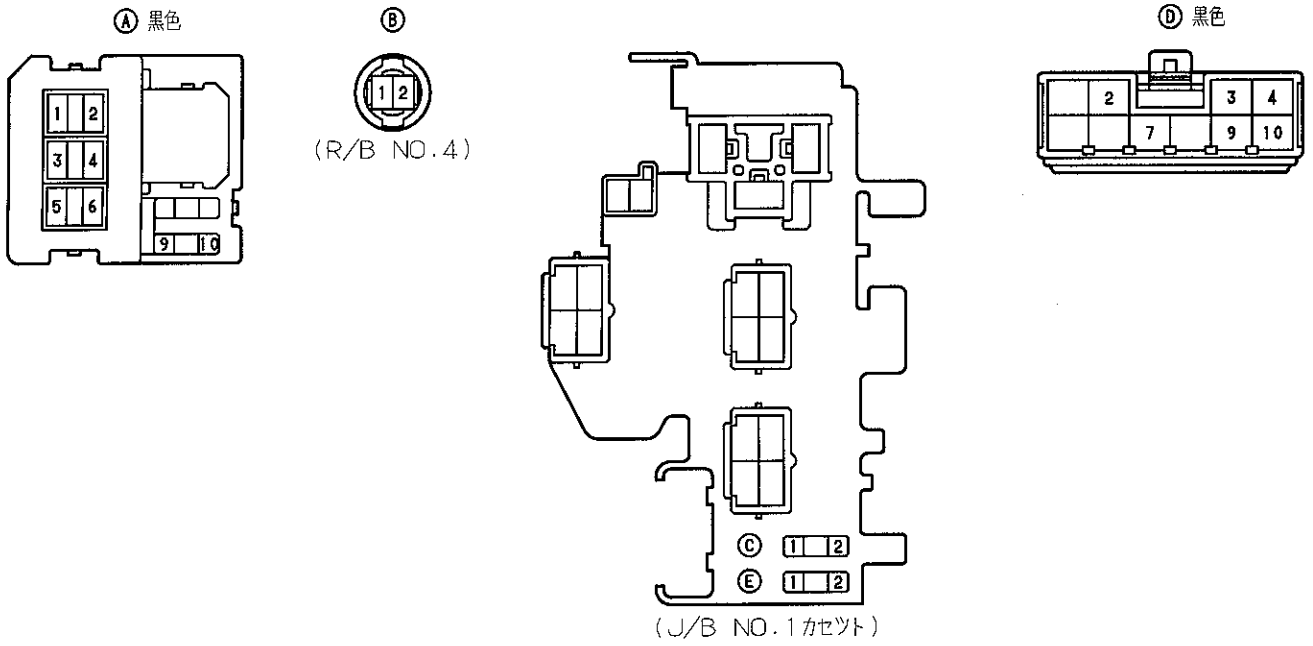

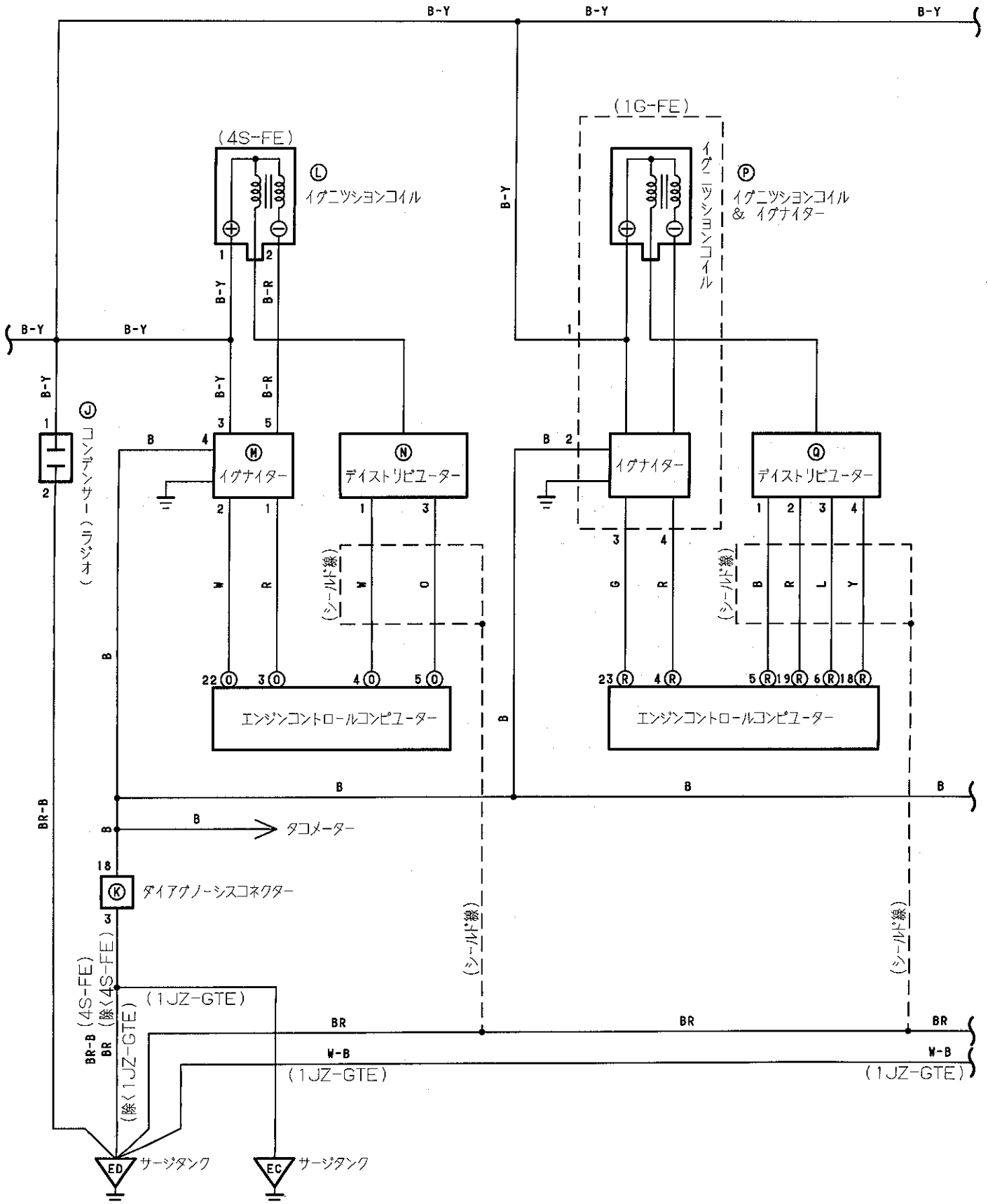

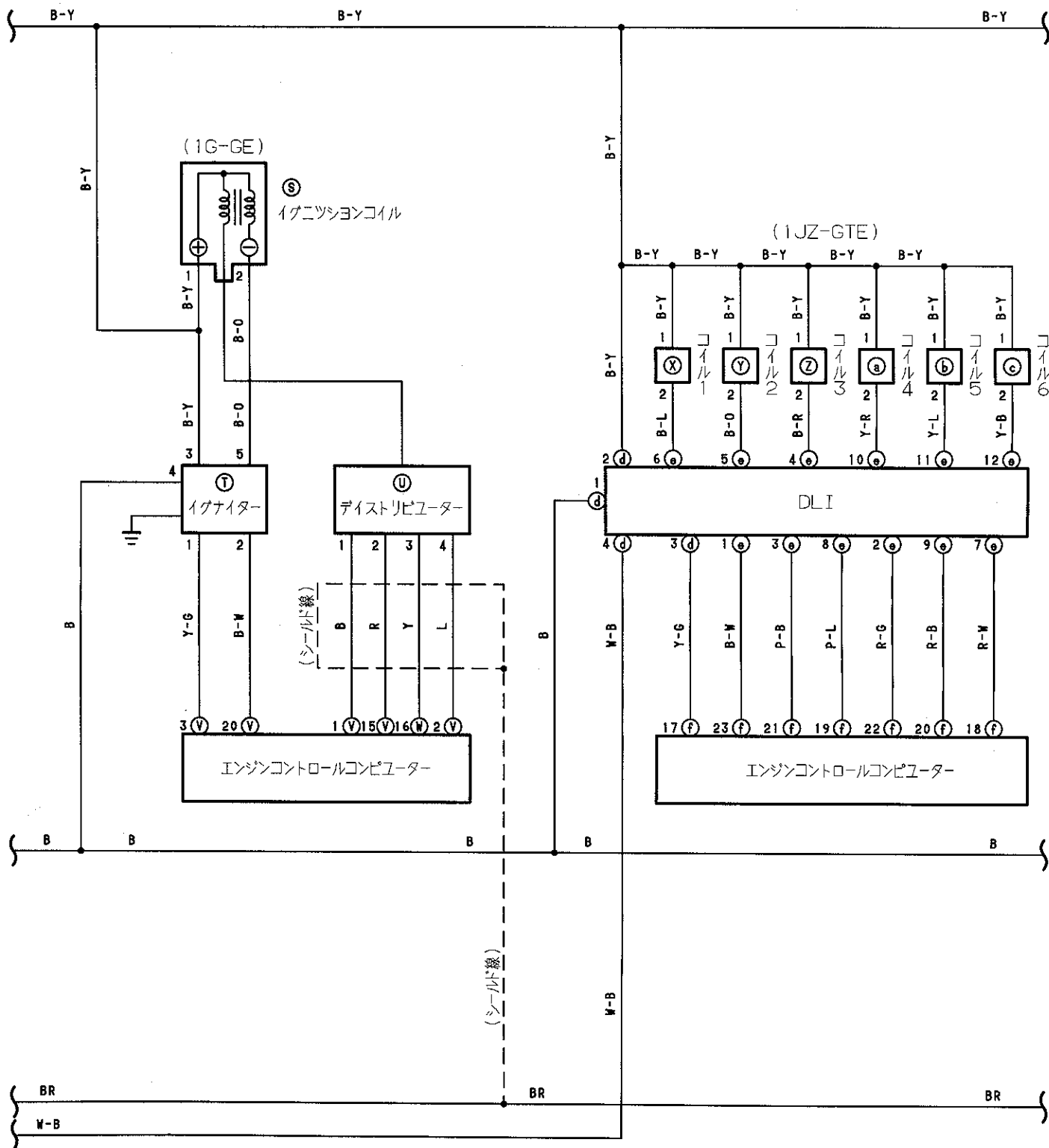

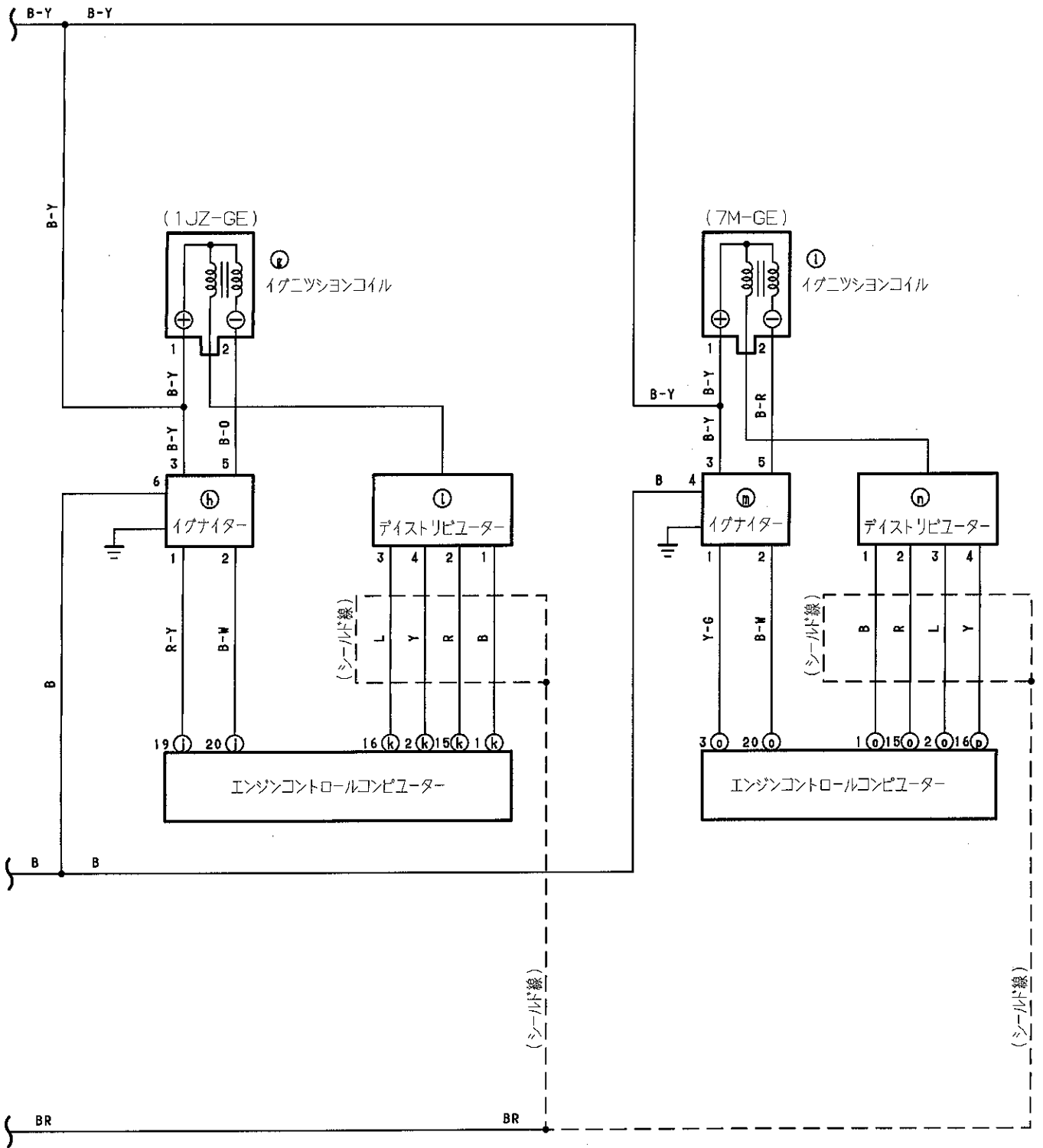



Ⓐ 黒色

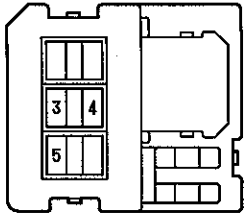

Ⓑ 黒色

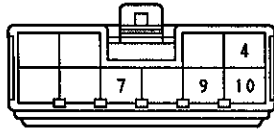

Ⓒ 灰色



Ⓓ 濃灰色



Ⓔ 黒色



Ⓕ



Ⓖ 黒色 (1G-GE) Ⓗ 濃灰色 (7M-GE) Ⓘ 茶色

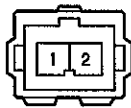

Ⓙ 灰色



Ⓚ 濃灰色

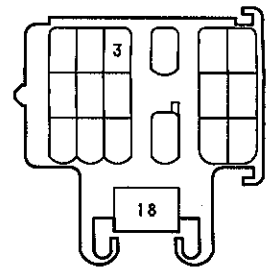

Ⓛ Ⓢ Ⓡ Ⓚ 黒色



Ⓜ 黒色

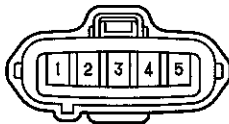

Ⓝ 黒色



Ⓞ Ⓡ Ⓥ ⓕ Ⓜ Ⓟ 濃灰色

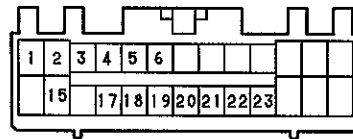

Ⓟ Ⓠ 濃灰色

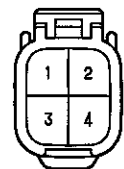

Ⓠ Ⓛ Ⓝ 黒色



Ⓣ 黒色



Ⓜ Ⓟ 濃灰色

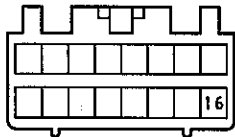

Ⓝ Ⓡ Ⓥ ⓕ Ⓜ Ⓟ 黒色



Ⓡ 黒色



Ⓢ 黒色

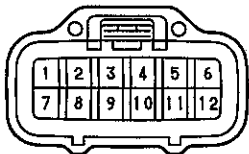

Ⓣ 黒色

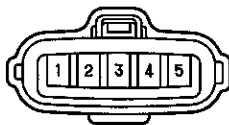

Ⓚ 濃灰色

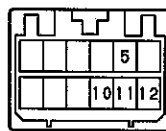

Ⓜ 黒色

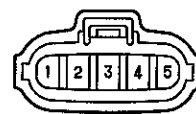

1A 黒色

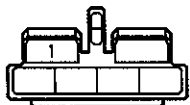

1E



1F

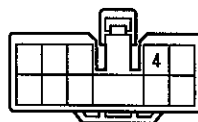

1G

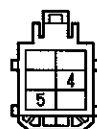

2D

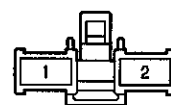

2E 黒色



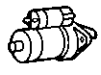

EA2 灰色

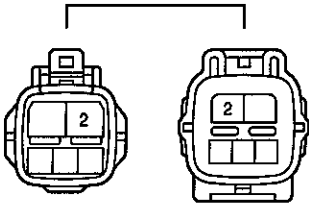

EA3 灰色

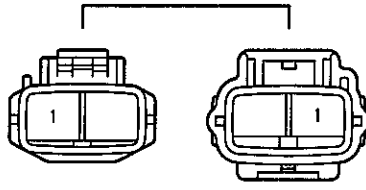

EE1 濃灰色

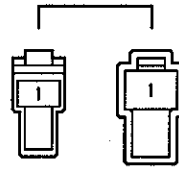

IL1 濃灰色

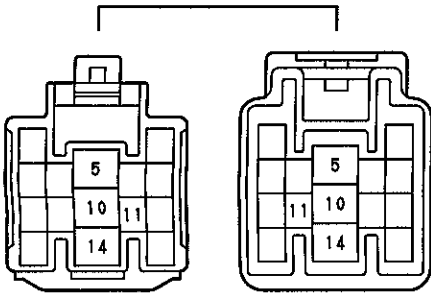

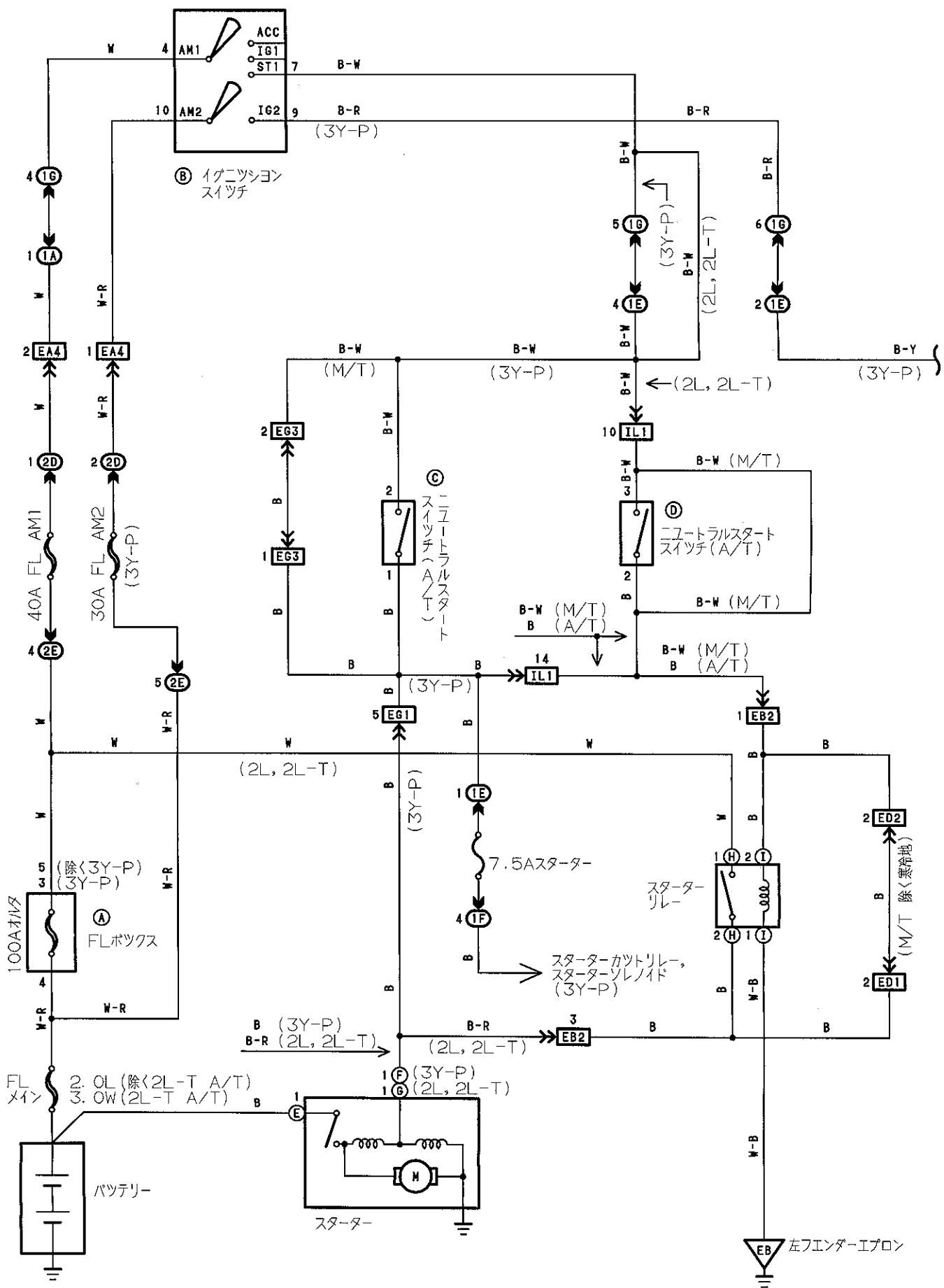

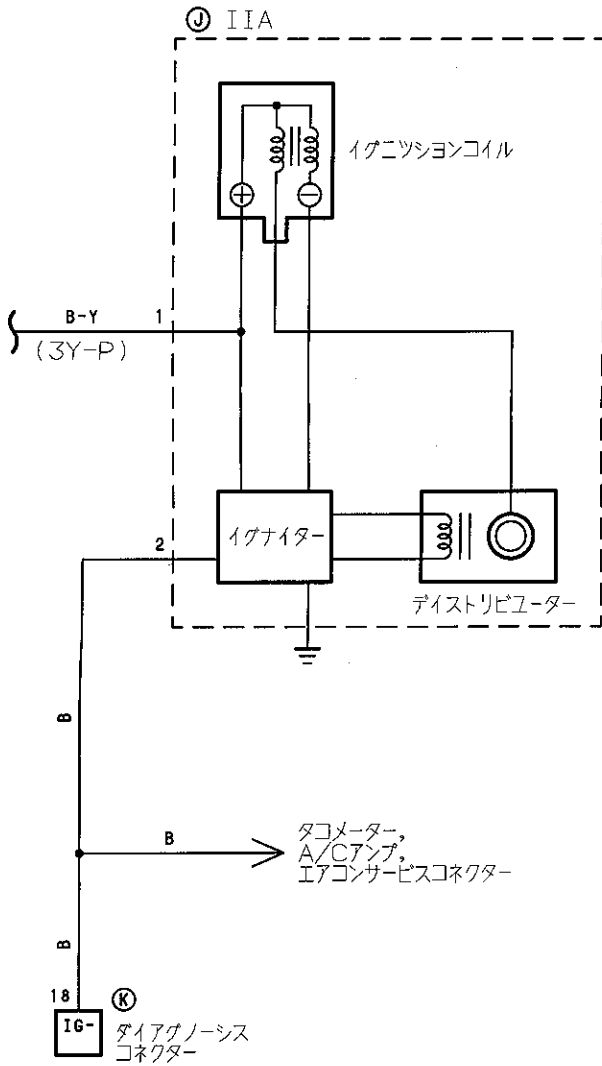
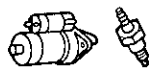

① 黒色

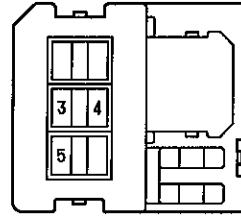

② 黒色

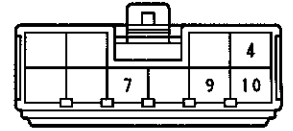

③ 灰色

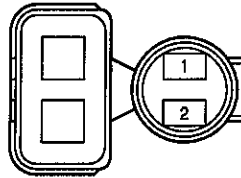

④ 灰色

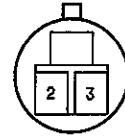

⑤



⑥ 黒色



⑦ 黒色



⑧ 灰色



⑨ 灰色

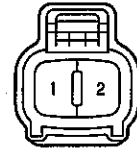

⑩ 濃灰色



⑪ 濃灰色

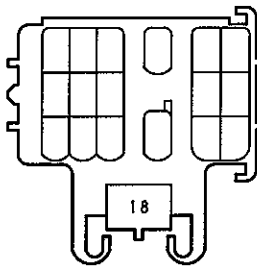

⑫A 黒色

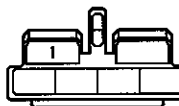

⑫E



⑫F

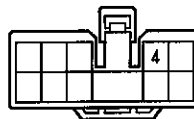

⑫G

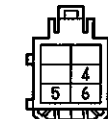

⑫B 黒色

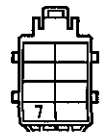



2D

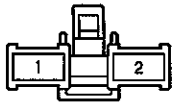

2E 黒色



EA4 灰色

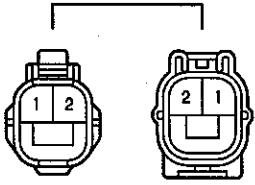

EB2 黒色

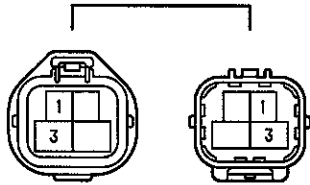

ED1 灰色

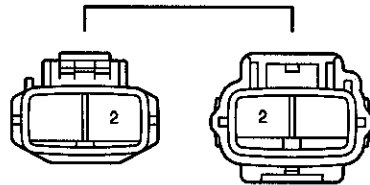

ED2 灰色

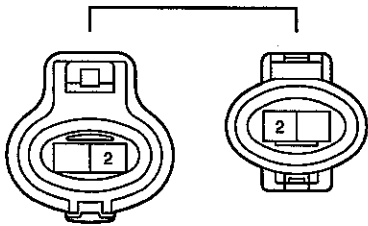

EG1 灰色

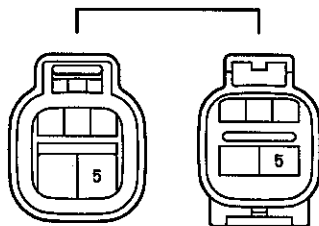

EG3 灰色

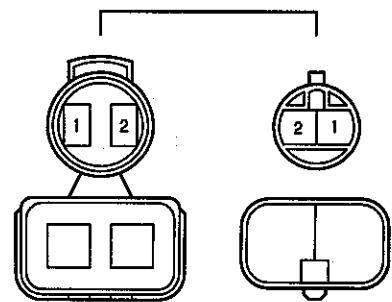

IL1 濃灰色

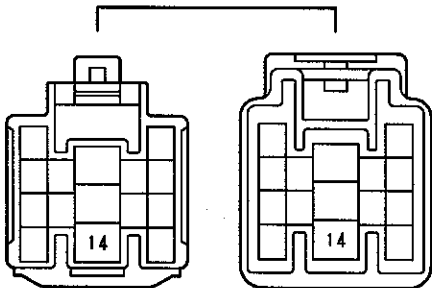

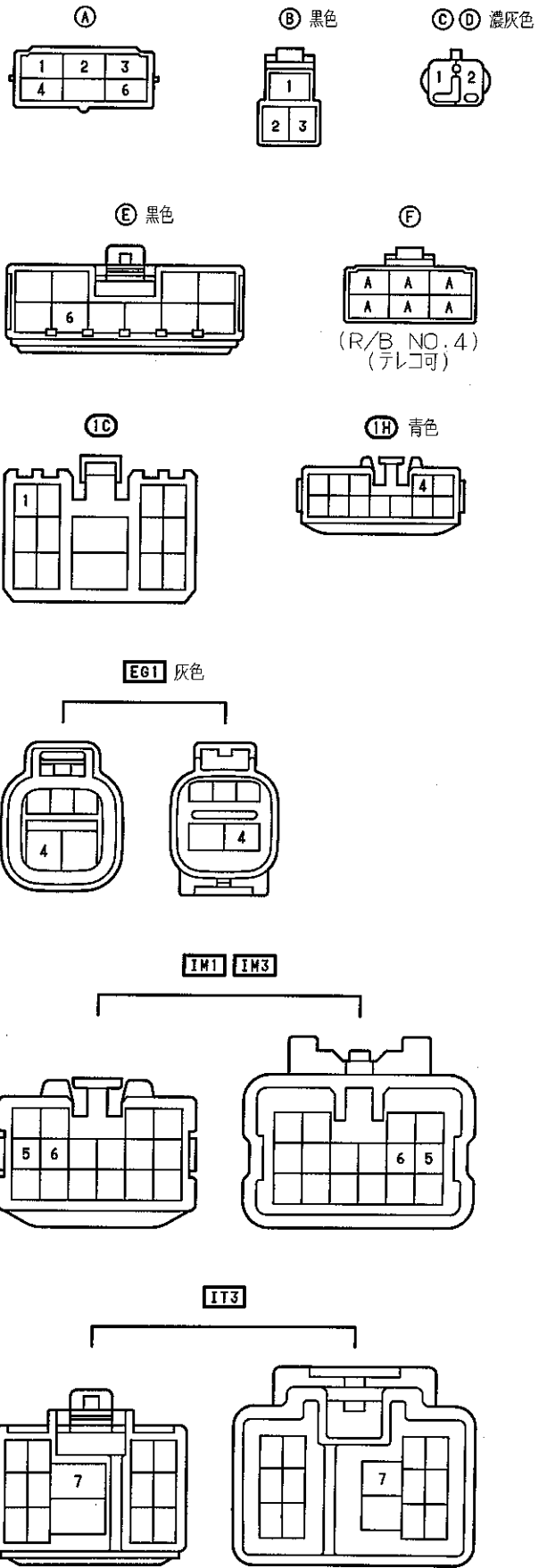
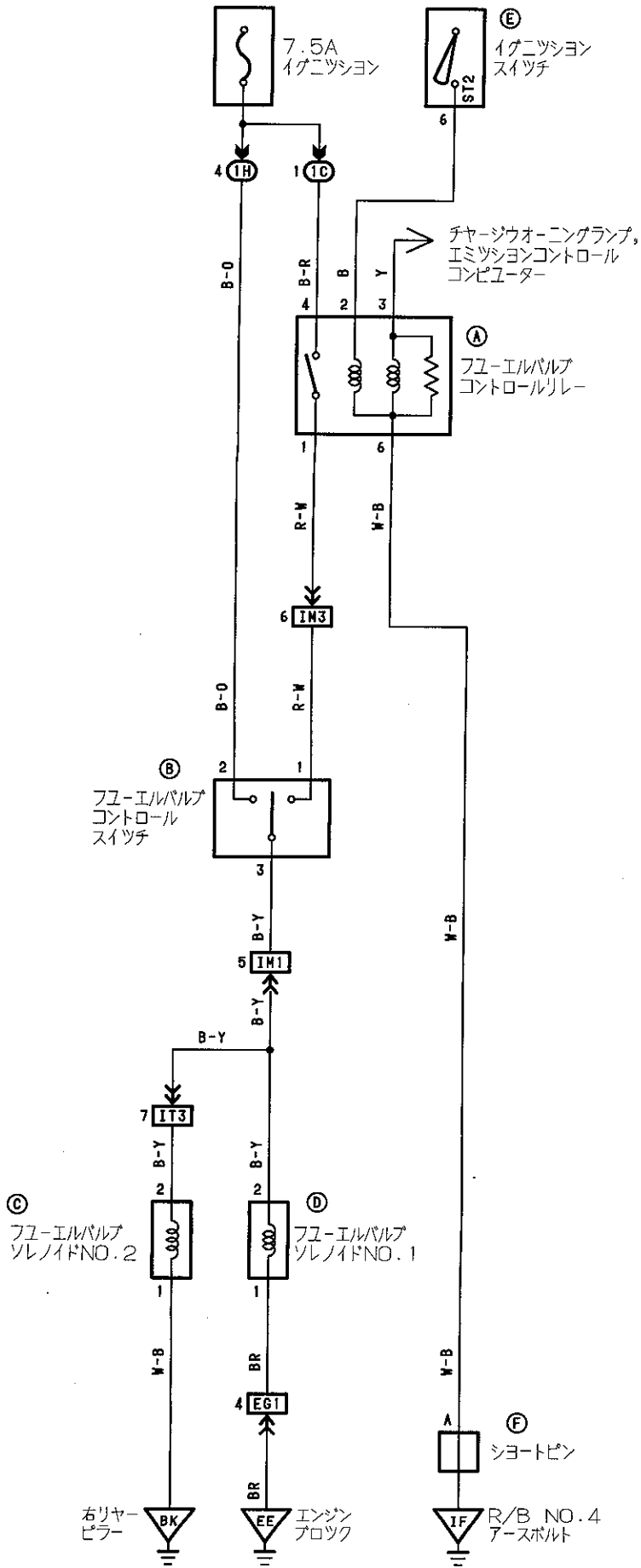

Ⓐ 黒色

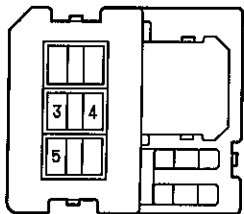

Ⓑ 青色

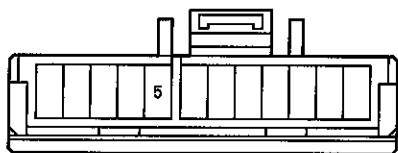

Ⓒ 茶色

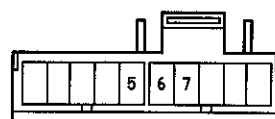

Ⓓ 黒色

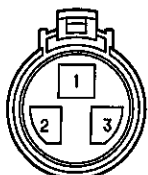

Ⓔ Ⓖ

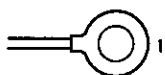

Ⓕ 黒色



ⓐ 黒色

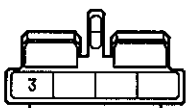

ⓑ

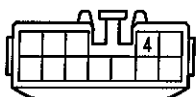

Ⓒ 黒色



Ⓔⓐ 灰色

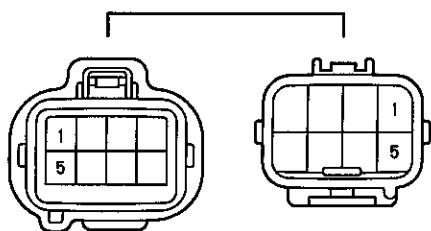

Ⓔⓑ 灰色

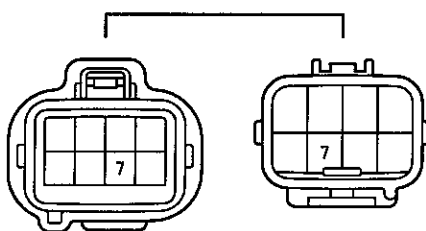

ⒺⒶ 灰色

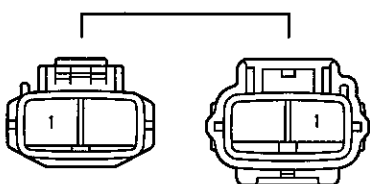

ⒺⒸ 灰色

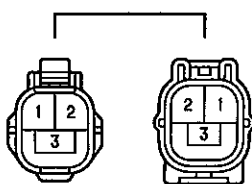

ⒺⒹ 黒色

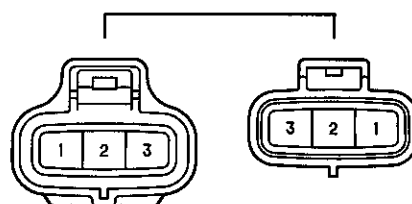

Ⓔⓐ

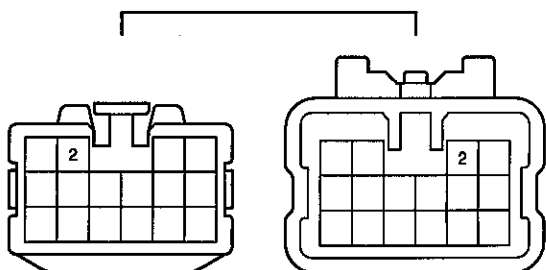

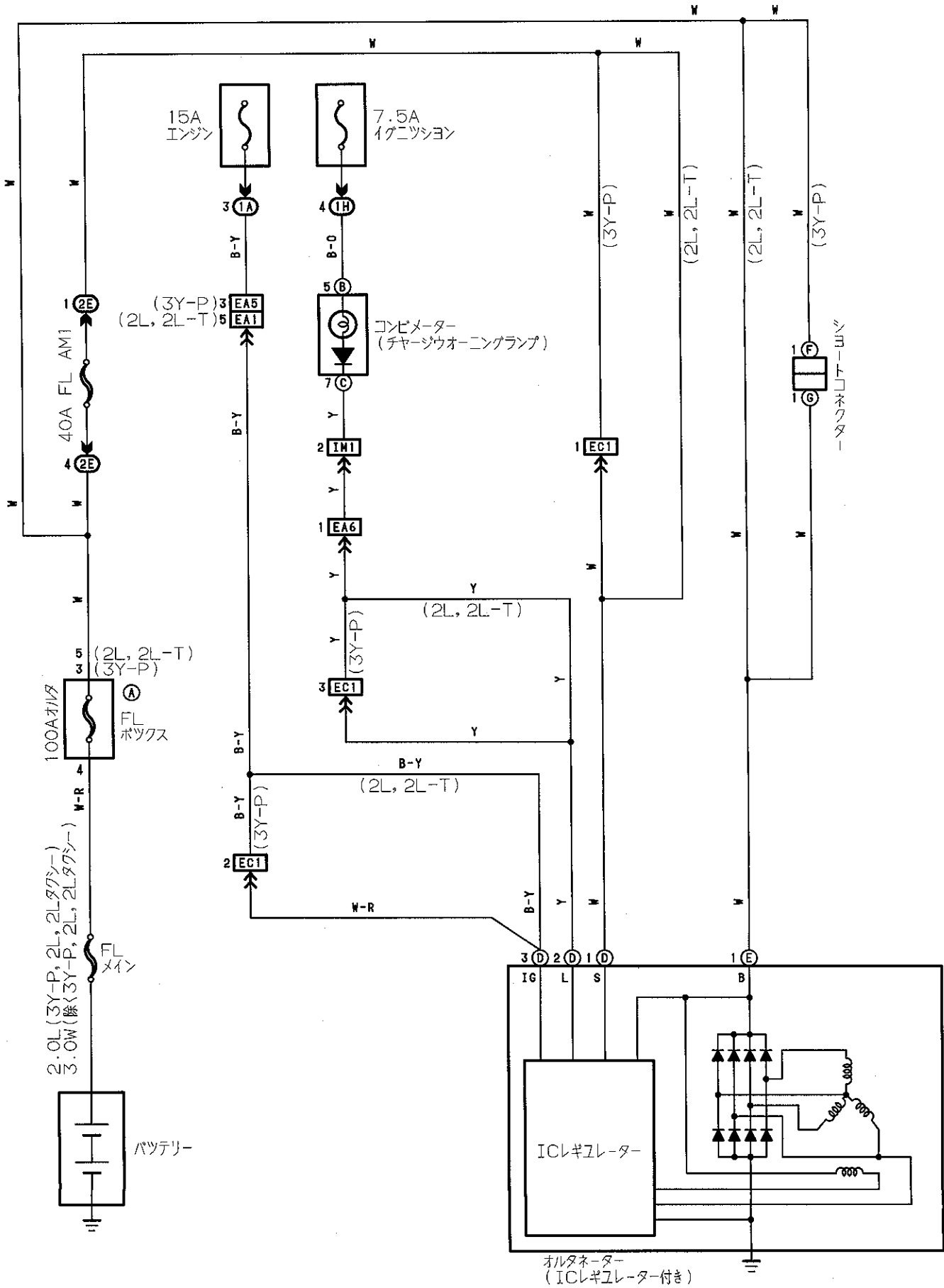

Ⓐ 黒色

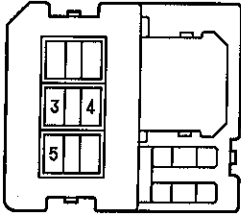

Ⓑ 青色

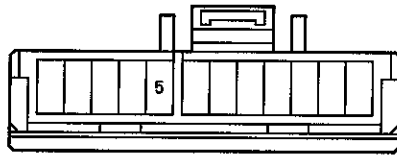

Ⓒ 茶色

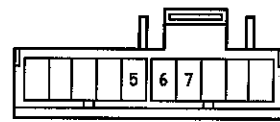

Ⓓ 黒色

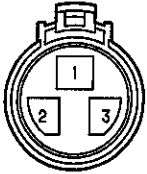

Ⓔ Ⓖ



Ⓕ 黒色



ⓐ 黒色

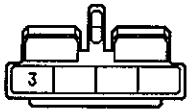

ⓑ



Ⓒ 黒色



Ⓔⓐ 灰色

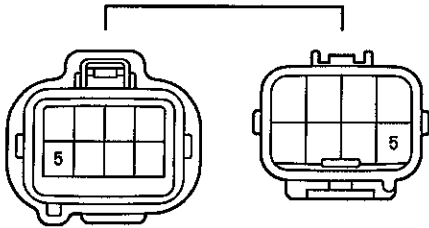

Ⓔⓑ 灰色

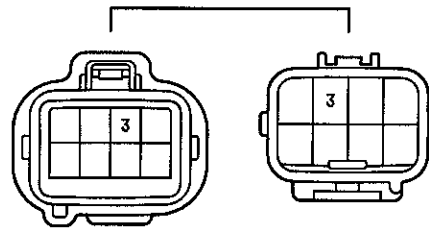

ⒺⒶ 灰色

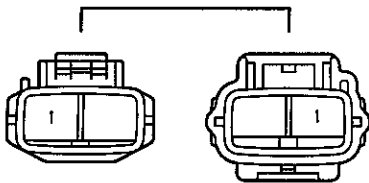

ⒺⒸ 黒色

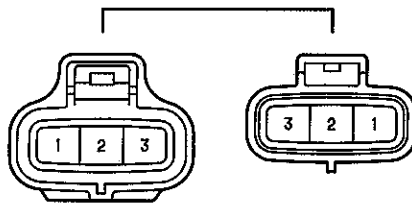

Ⓔⓓ

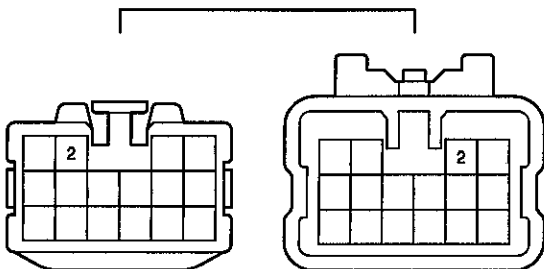

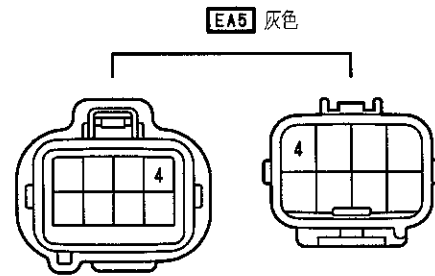
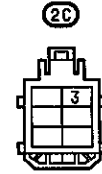
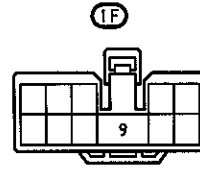
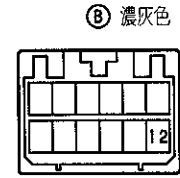
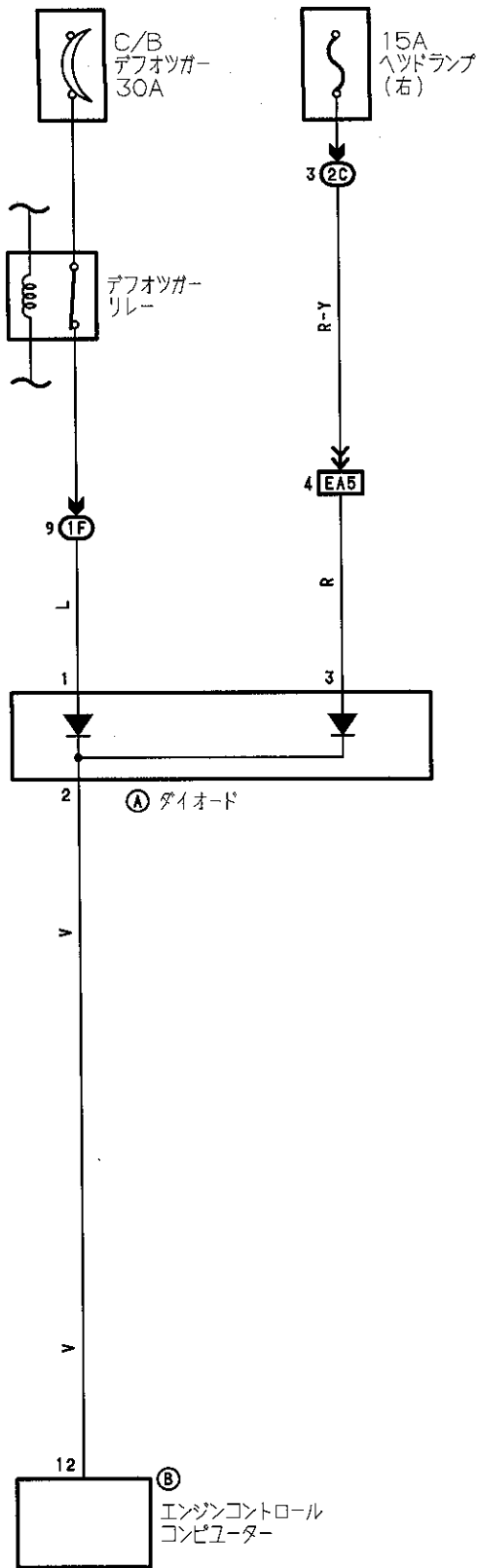

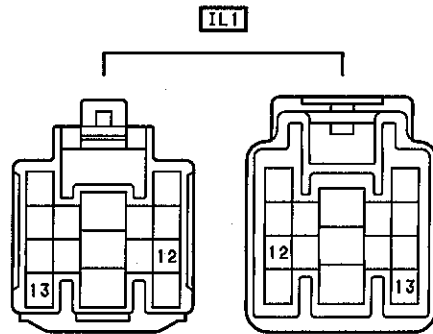
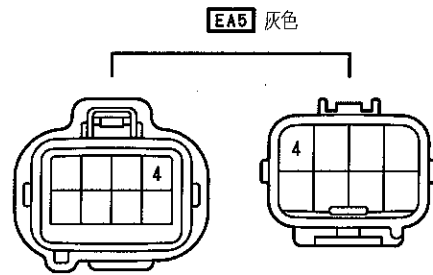
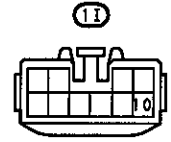
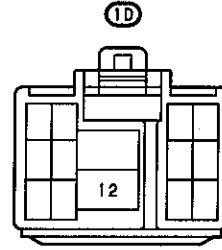
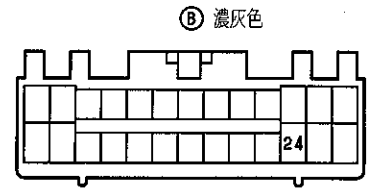
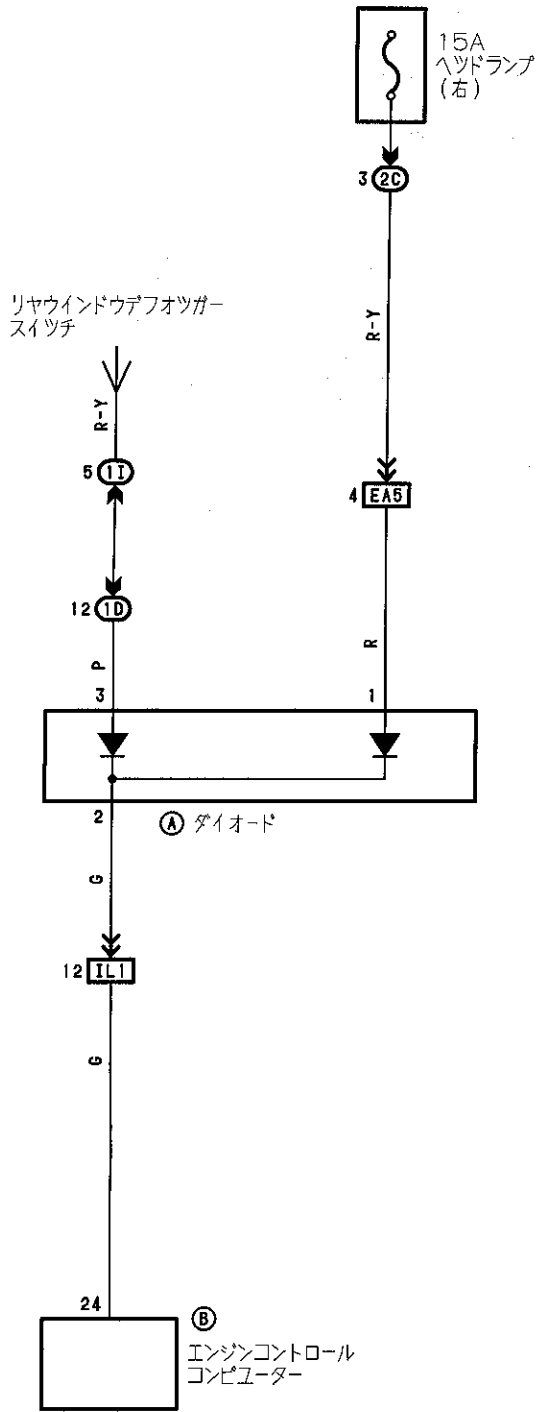



フューエルヒーター

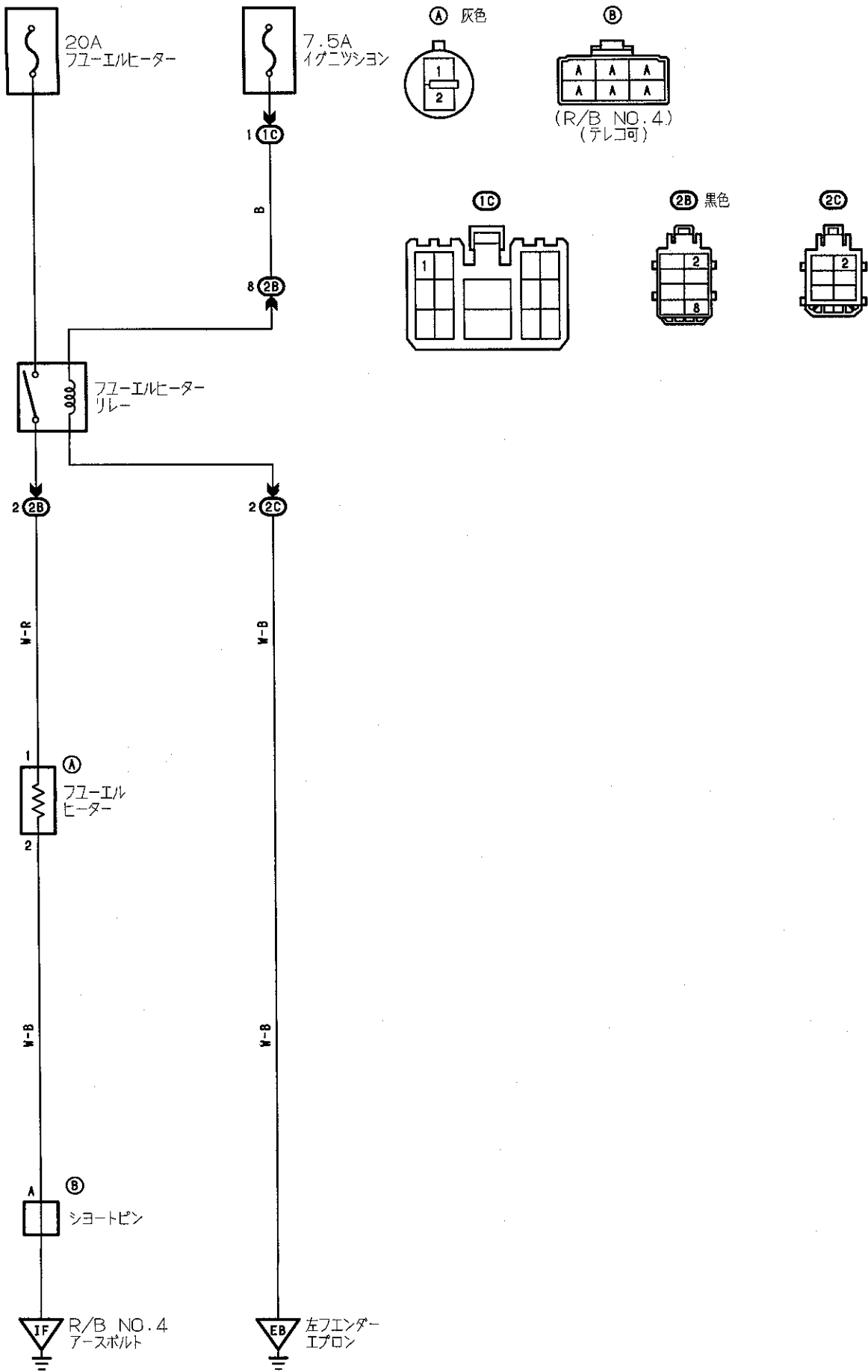

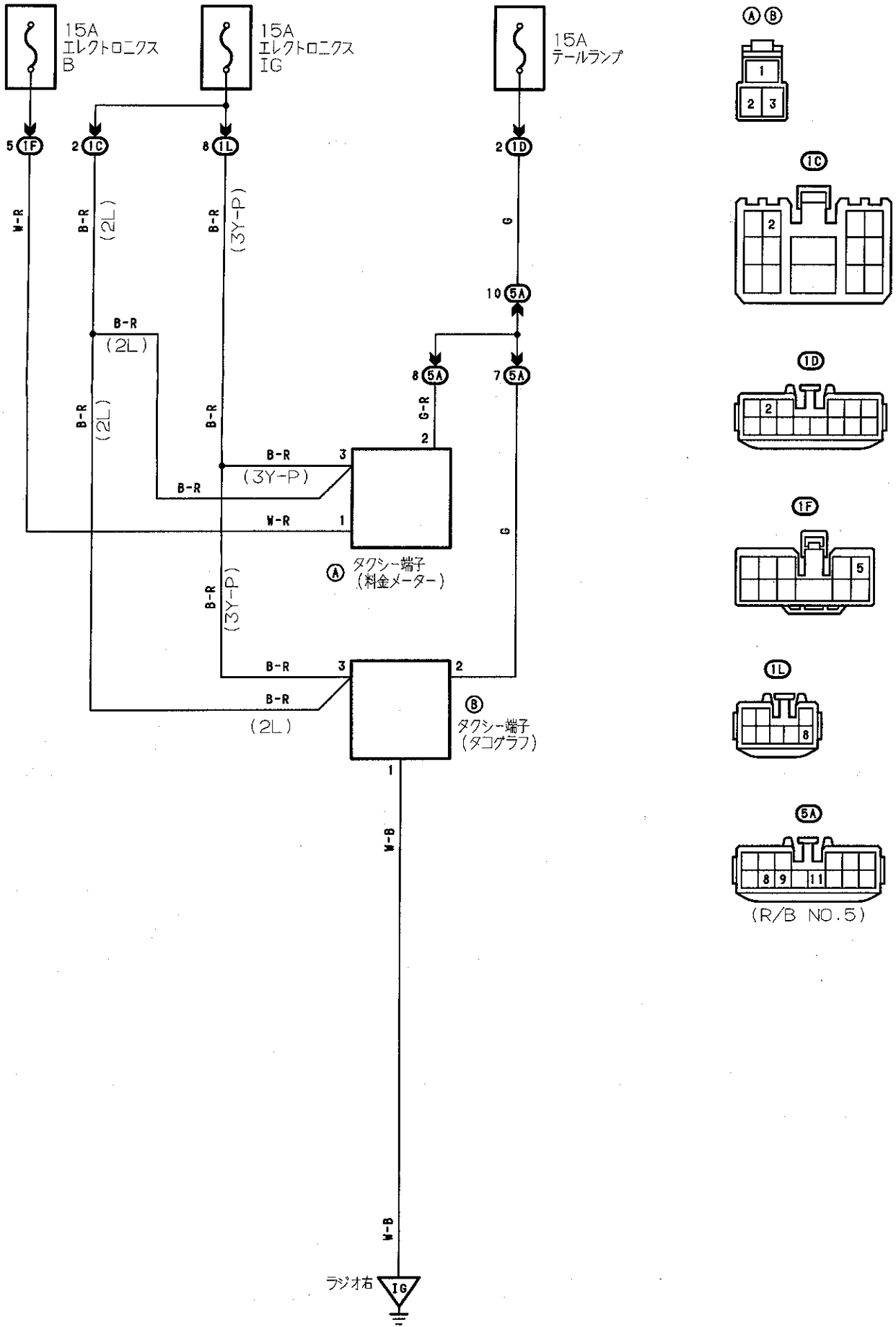

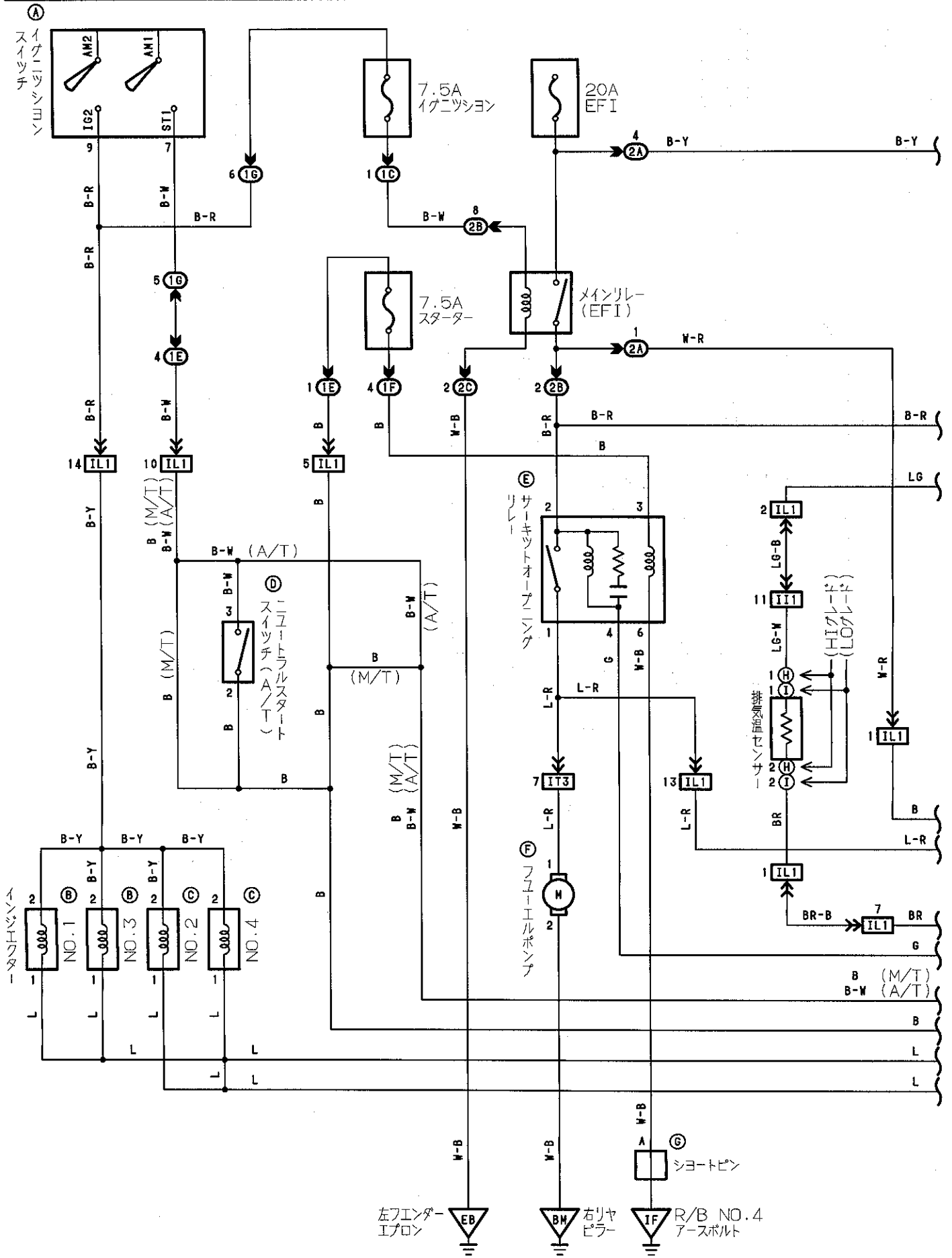

Ⓐ 黒色

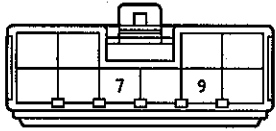

Ⓑ 灰色



Ⓒ 茶色



Ⓓ 灰色

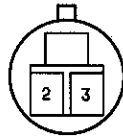

Ⓔ

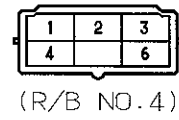

Ⓕ 濃灰色又は灰色



Ⓖ

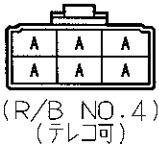

Ⓗ 濃灰色



Ⓘ 灰色



Ⓙ 灰色

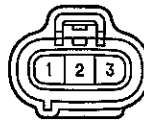

Ⓚ 黒色

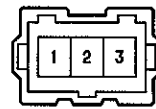

Ⓛ 濃灰色

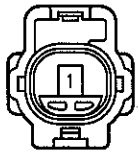

Ⓜ 濃灰色

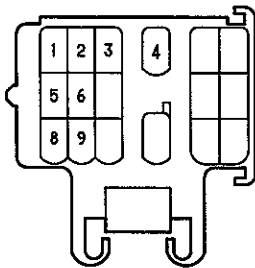

Ⓝ 濃灰色

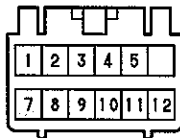

Ⓞ 濃灰色

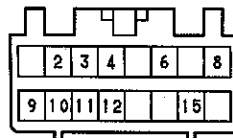

Ⓟ 濃灰色

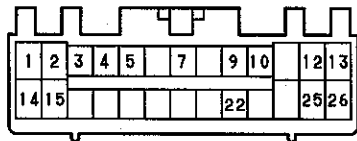

Ⓡ

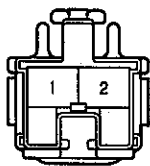

Ⓡ 青色

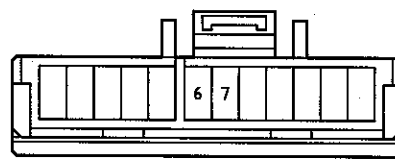

Ⓢ 灰色

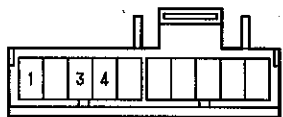

Ⓣ 濃灰色



Ⓤ 濃緑色



Ⓥ 濃緑色



Ⓦ



Ⓧ 黒色

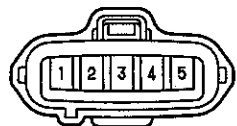

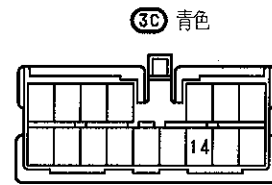
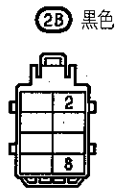
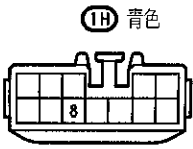
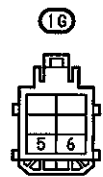
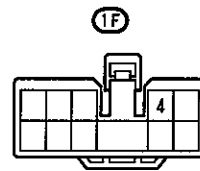
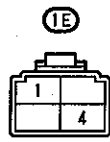
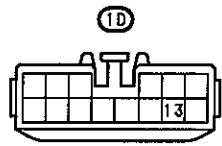
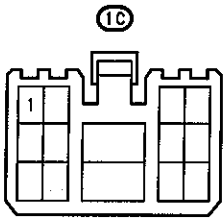

111

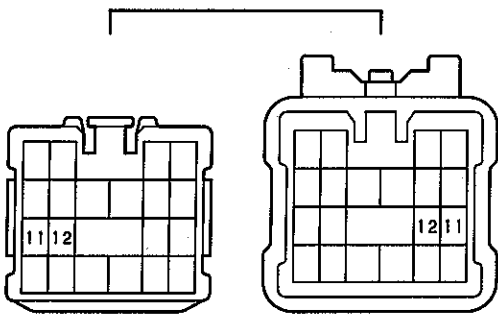

1L1 濃灰色

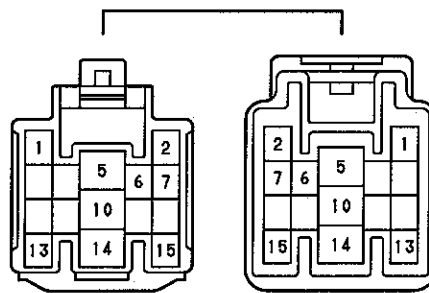

1L2 濃灰色

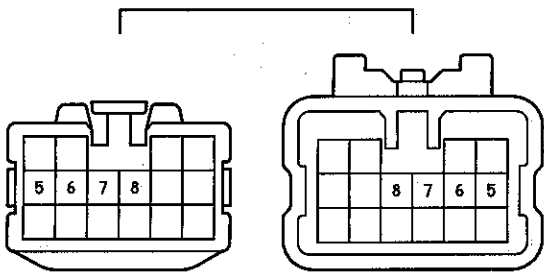

1M1 1M3

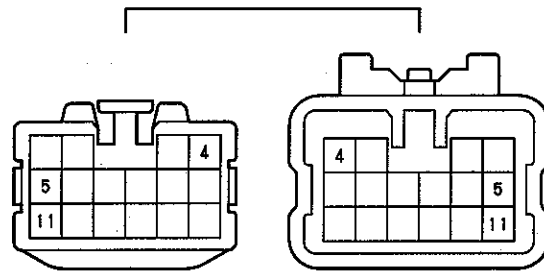

1T3

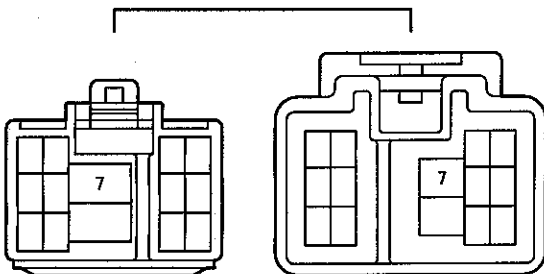

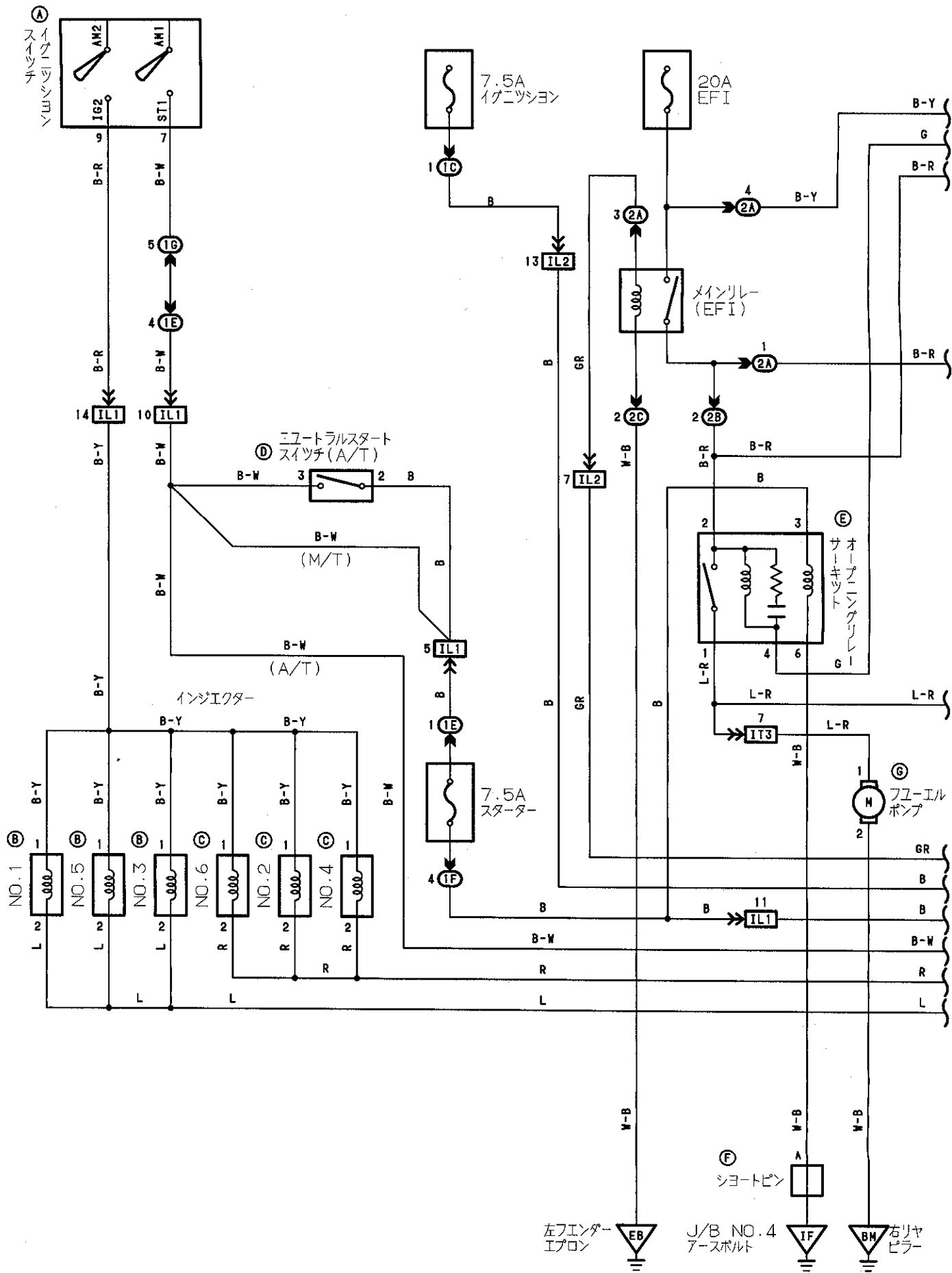



エンジンコントロール
コンピューター

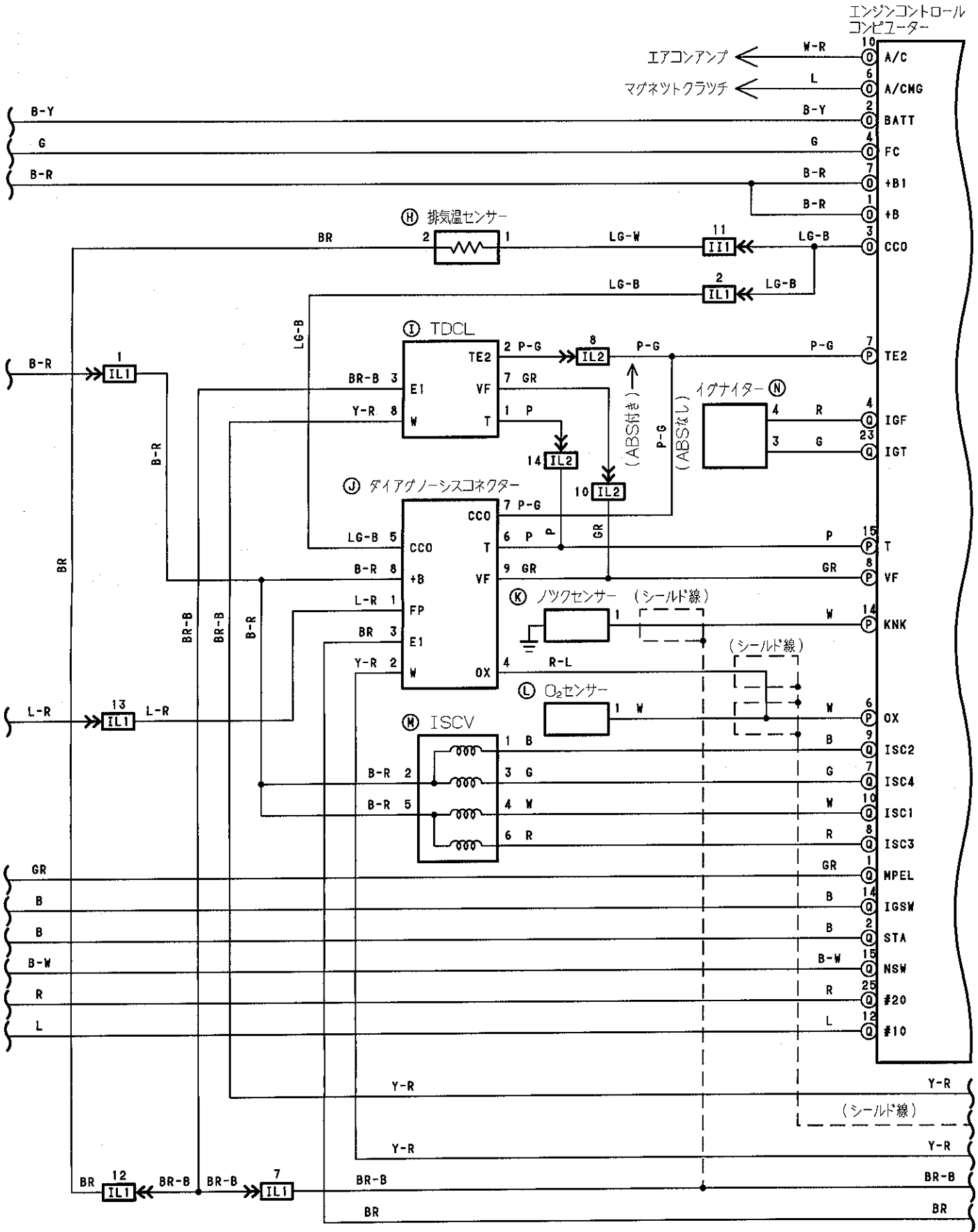

エンジンコントロール
コンピューター

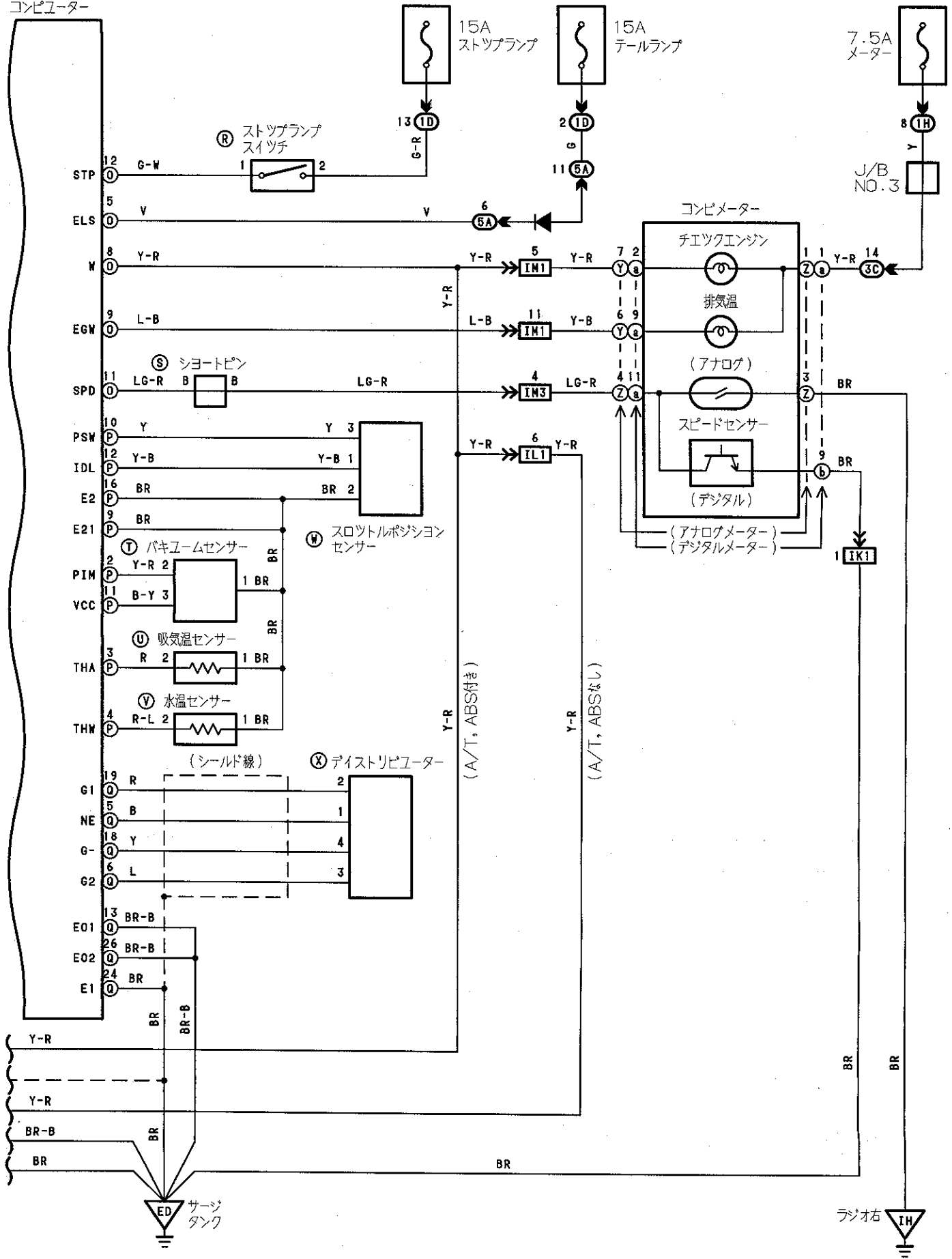

Ⓐ 黒色

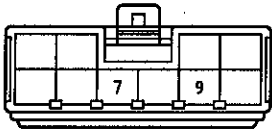

Ⓑ 濃灰色



Ⓒ 茶色



Ⓓ 灰色



Ⓔ

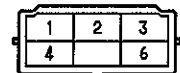

(R/B NO.4)

Ⓕ

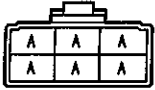

(R/B NO.4)
(テレコ可)

Ⓖ 濃灰色又は灰色



Ⓗ 濃灰色



Ⓘ 濃灰色

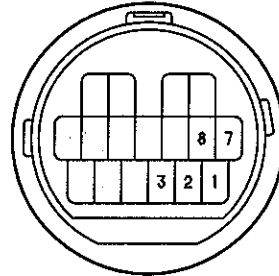

Ⓙ 濃灰色

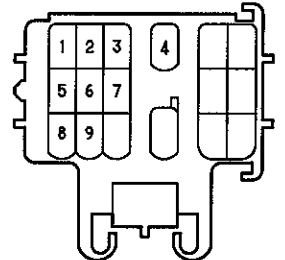

Ⓚ



Ⓛ 濃灰色



Ⓜ 灰色



Ⓝ

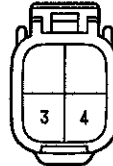

Ⓞ 濃灰色

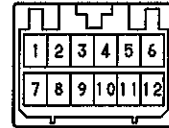

Ⓟ 濃灰色

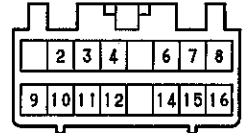

Ⓠ 濃灰色

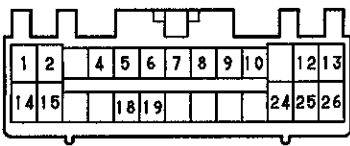

Ⓡ

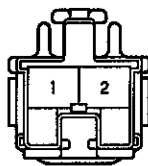

Ⓢ

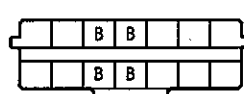

Ⓣ

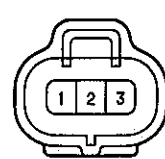

Ⓤ 濃灰色



Ⓟ 濃緑色



Ⓜ 黒色



Ⓝ 濃灰色

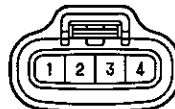

Ⓨ 青色

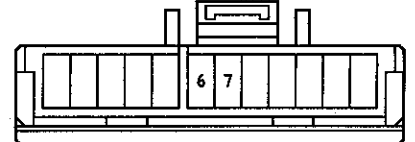

Ⓩ 灰色

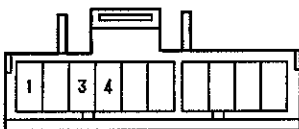

Ⓛ 茶色

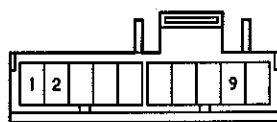

Ⓜ

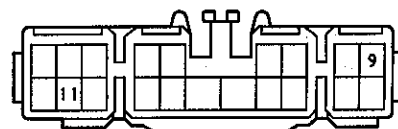

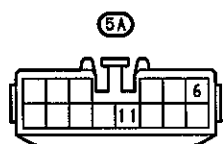
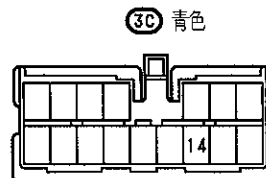
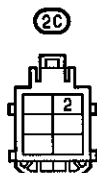
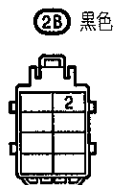
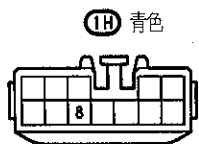
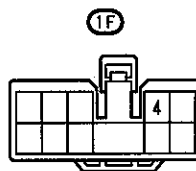
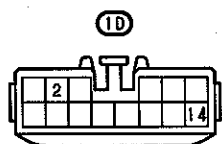
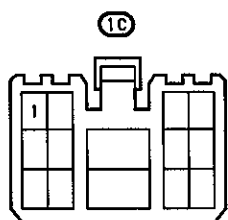

III1

IK1

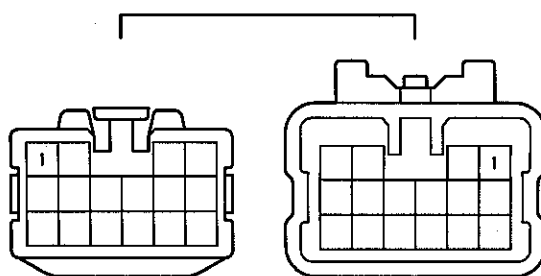
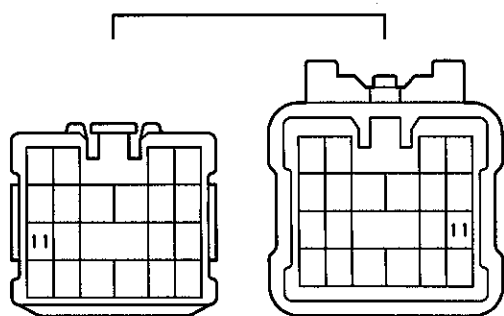

IL1 濃灰色

IL2 濃灰色

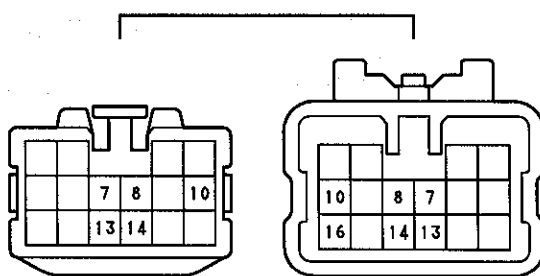
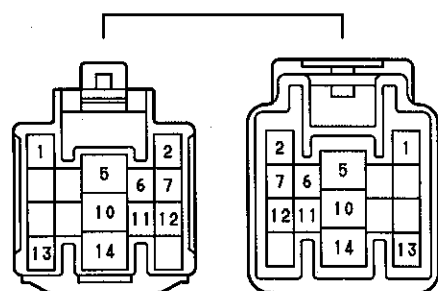

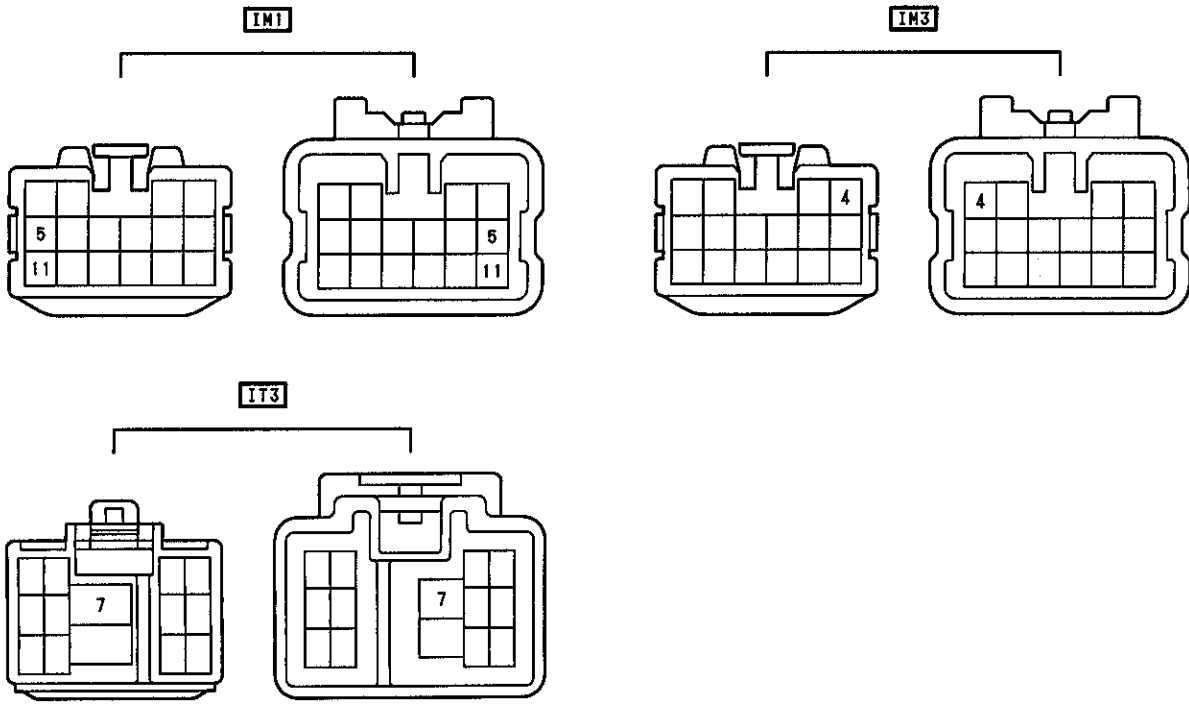

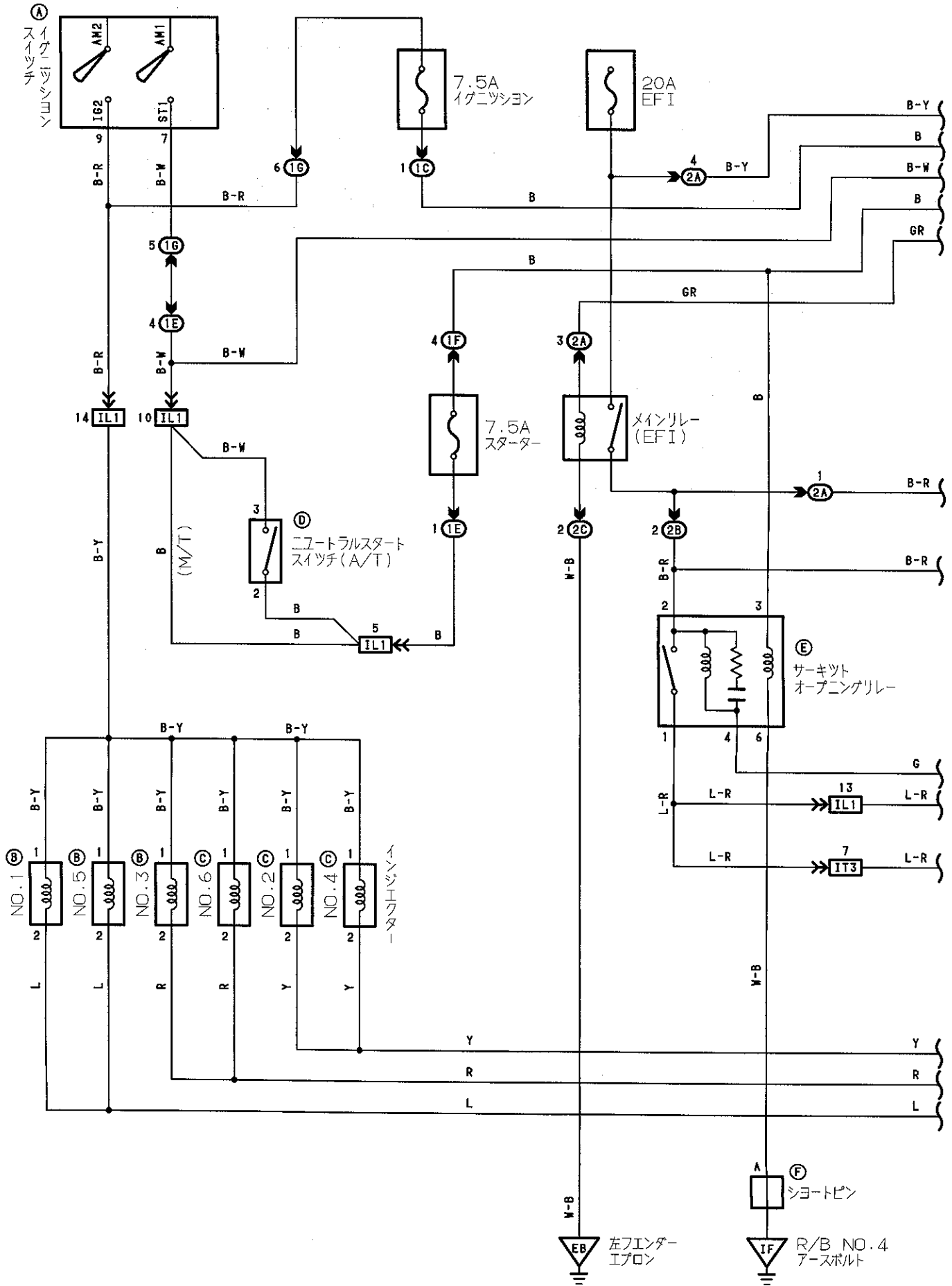

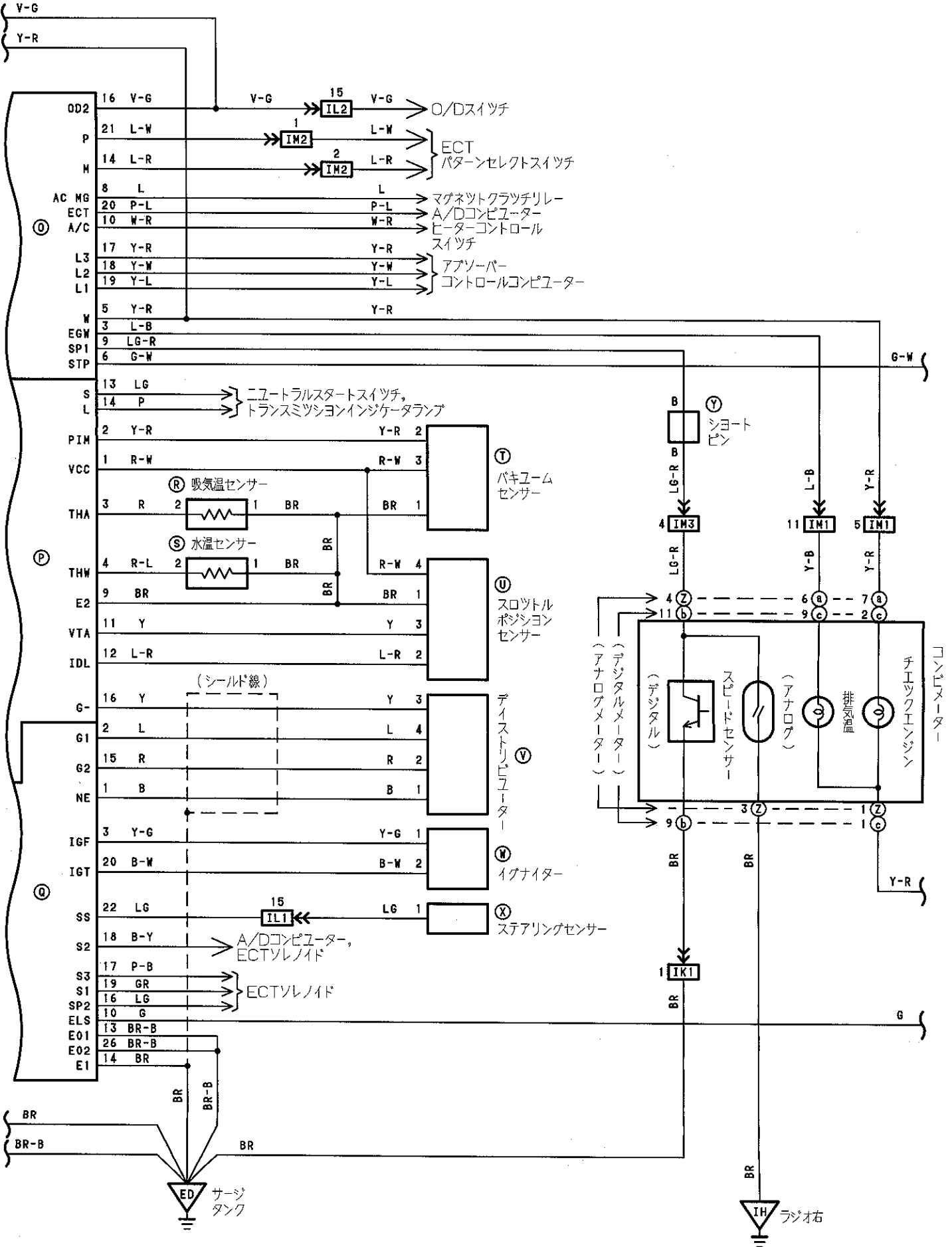

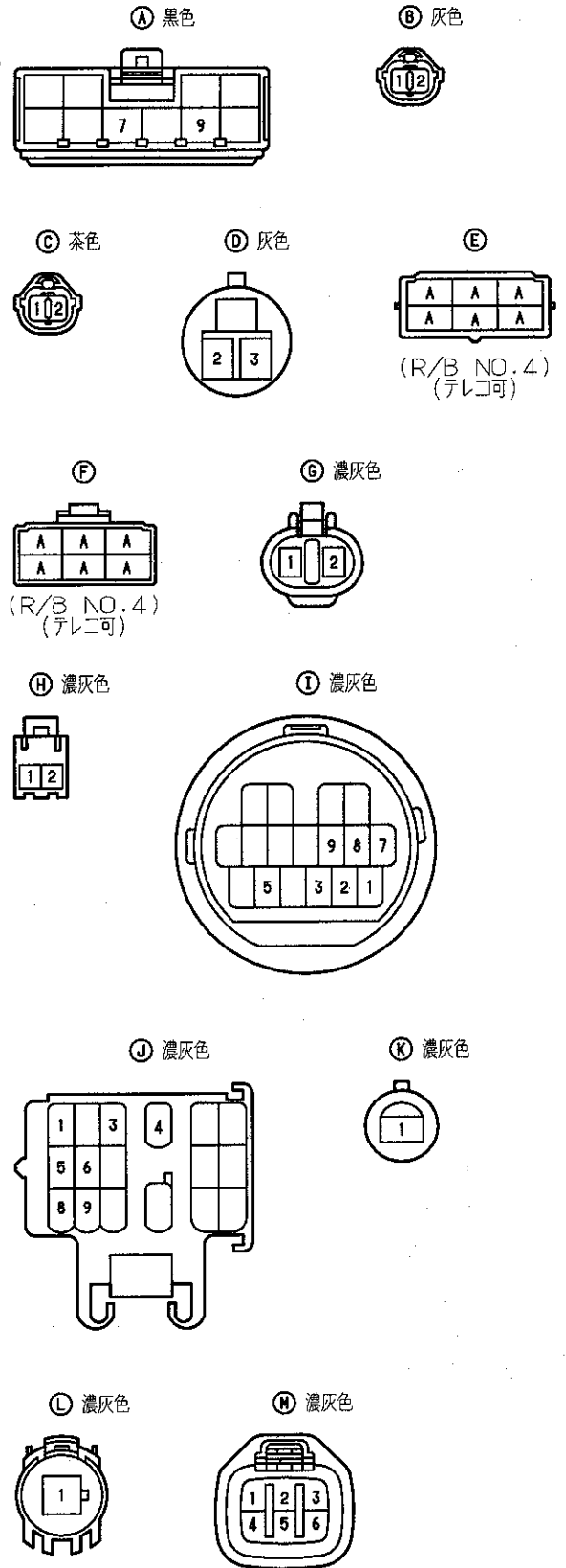
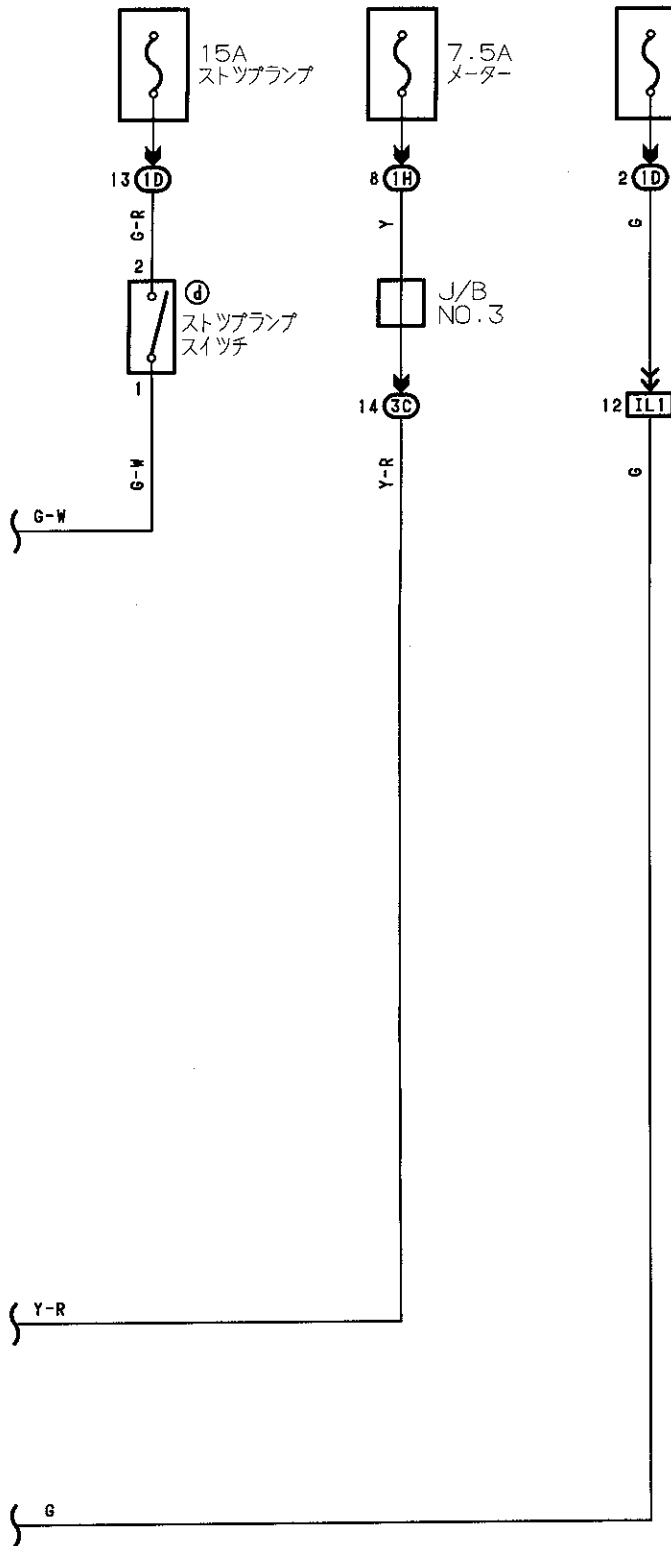

Ⓝ 青色

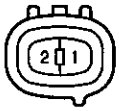

ⓓ 濃灰色

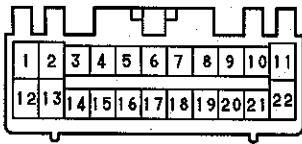

ⓔ 濃灰色

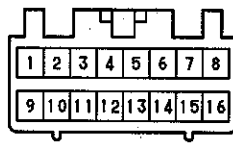

ⓕ 濃灰色

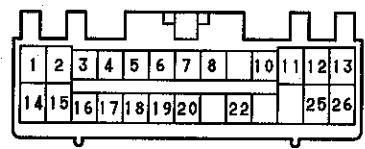

Ⓡ 濃灰色



Ⓢ 緑色



Ⓣ 濃灰色

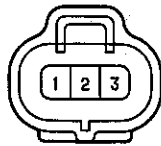

Ⓤ 黒色



ⓖ 濃灰色

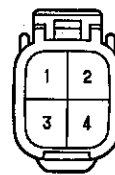

ⓗ 黒色

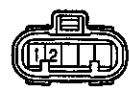

Ⓧ



Ⓨ

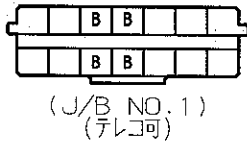

Ⓩ 灰色

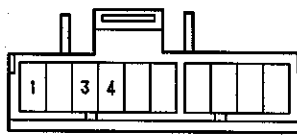

ⓐ 青色

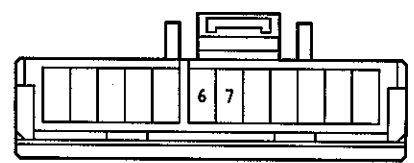

ⓑ

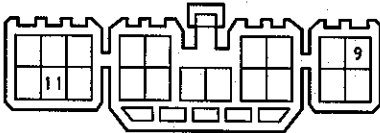

ⓒ 茶色

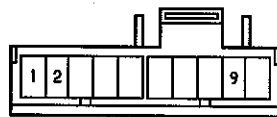

ⓓ 青色

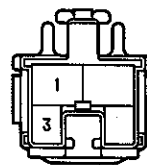

ⓓ

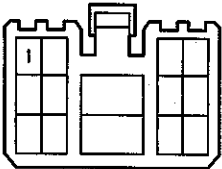

ⓓ

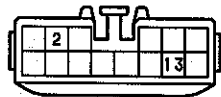

ⓔ



ⓔ

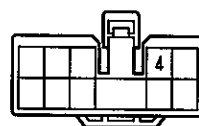

ⓖ 2C

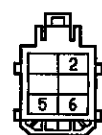

ⓓ 青色

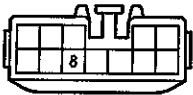

2A 茶色

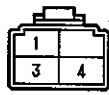

2B 黒色

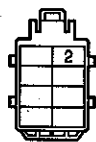

3C 青色

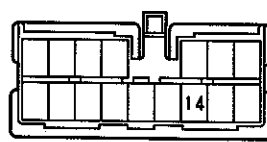

II1

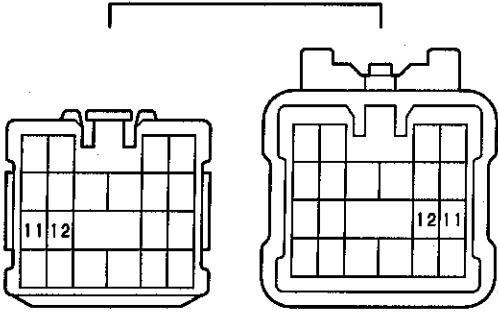

IK1 IM1 IM3

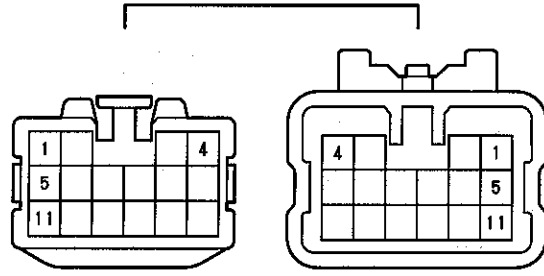

IL1 濃灰色

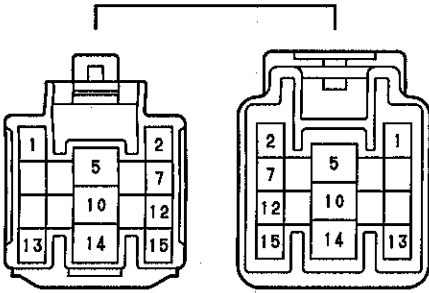

IL2 濃灰色

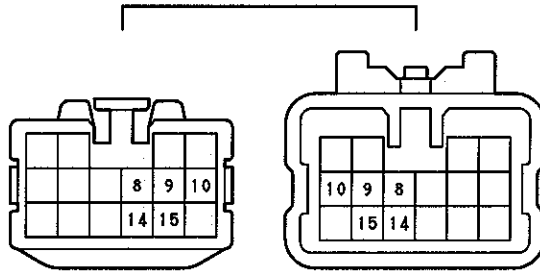

IW2

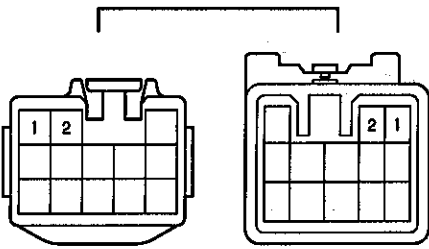

IT3

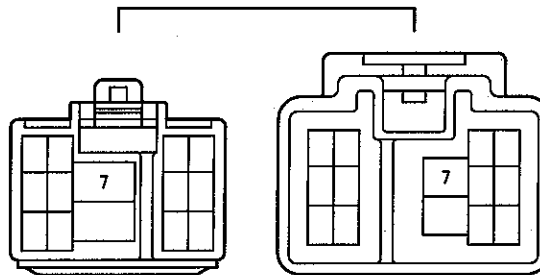

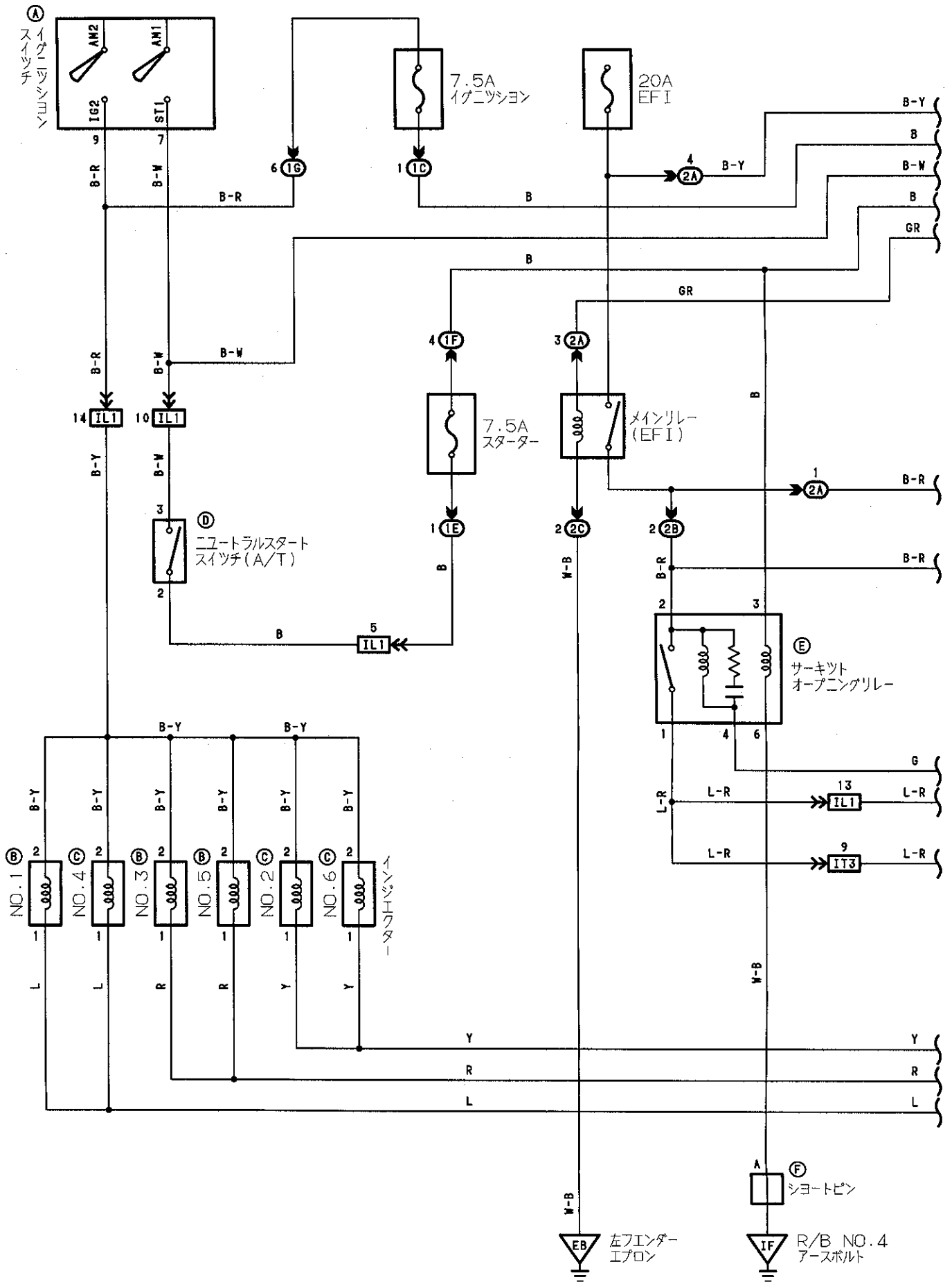

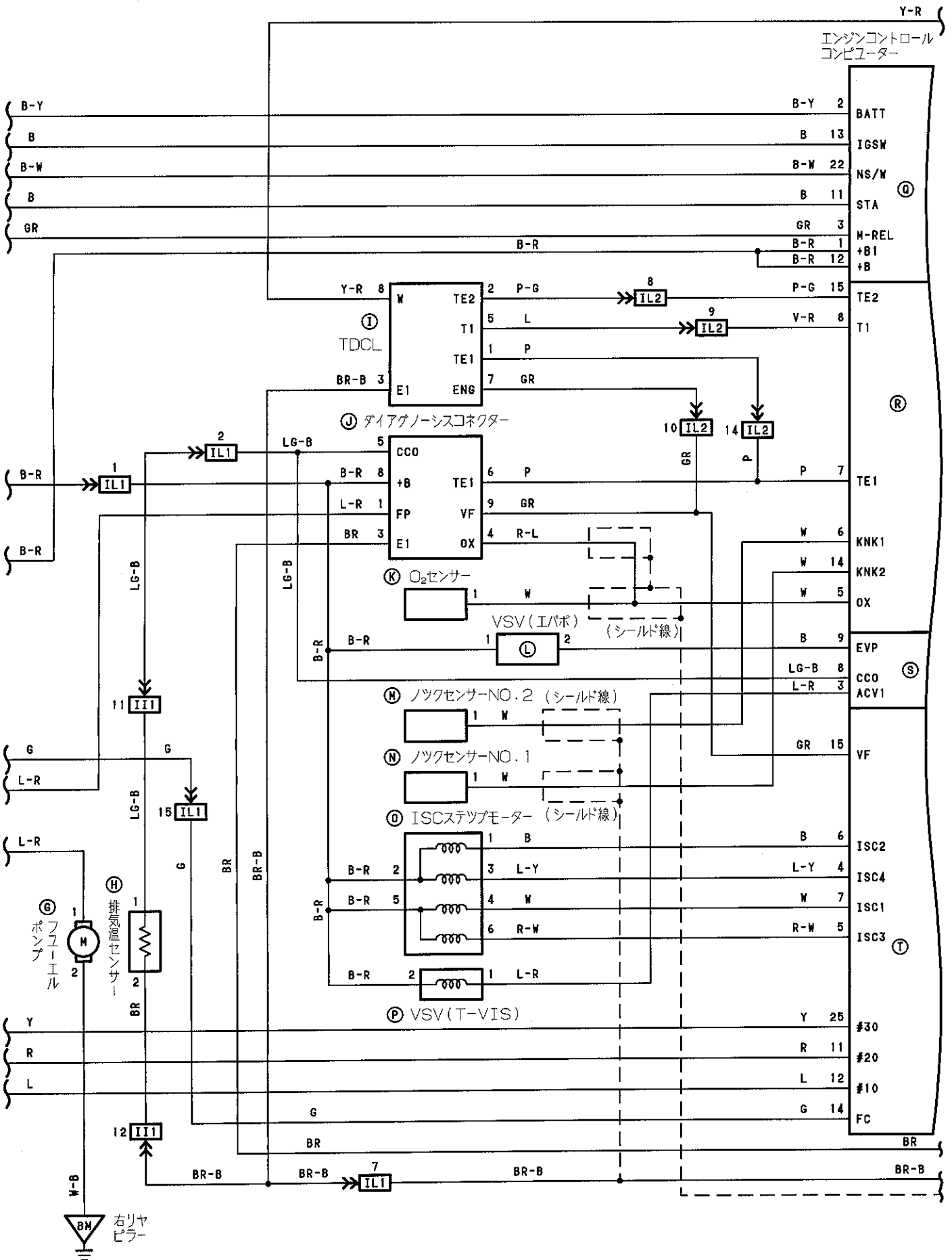

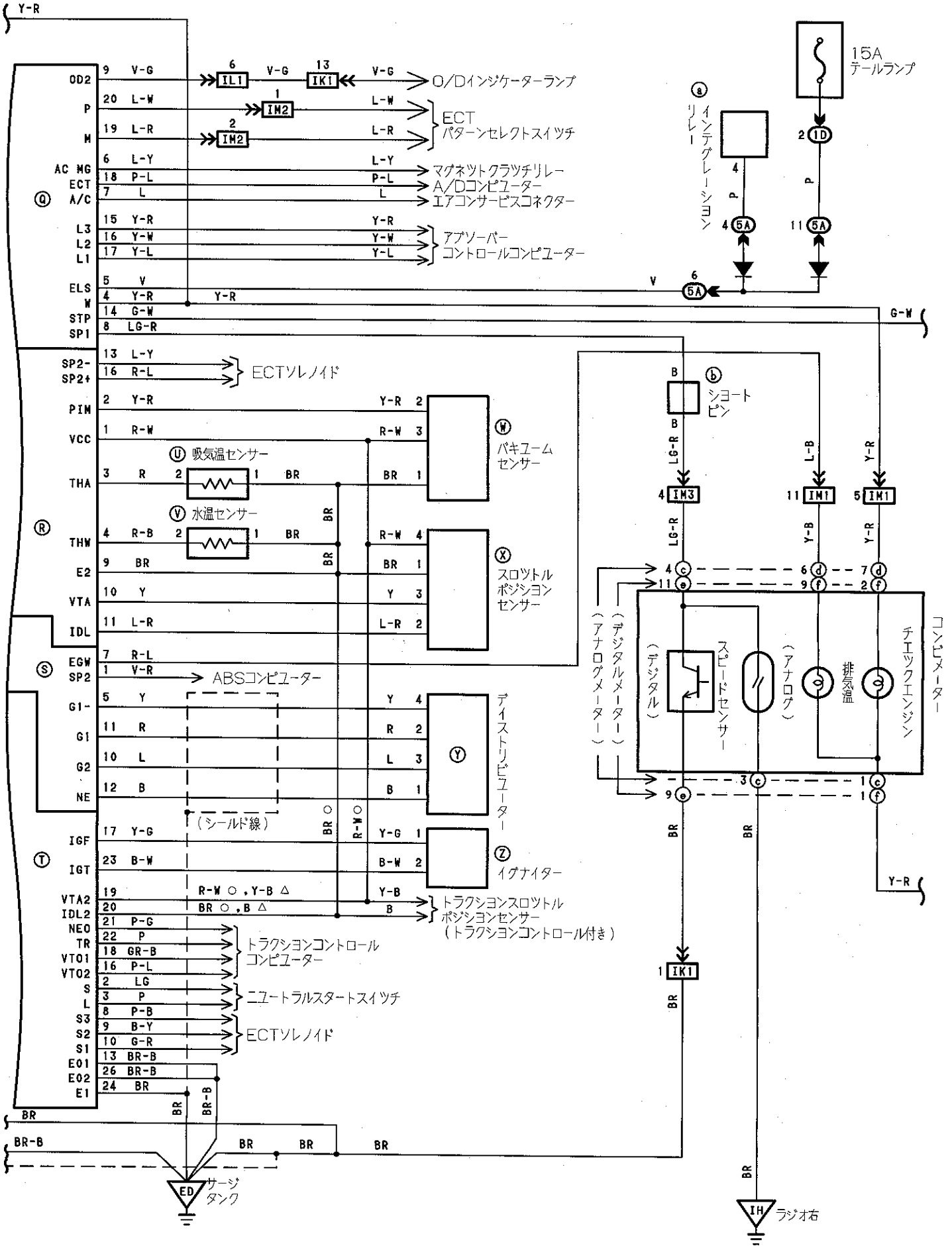

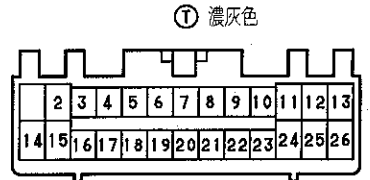
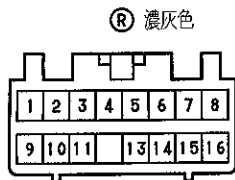
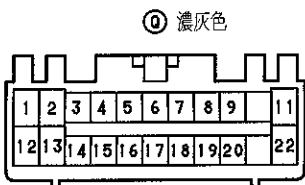
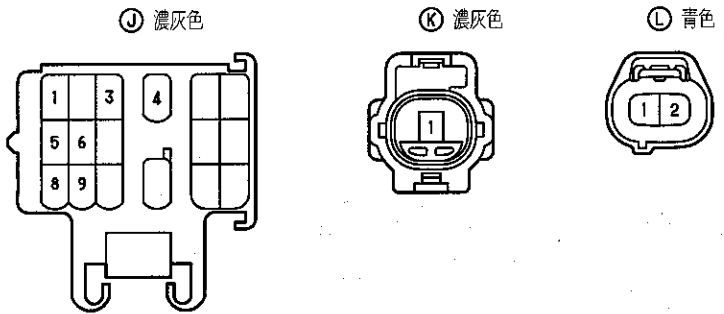
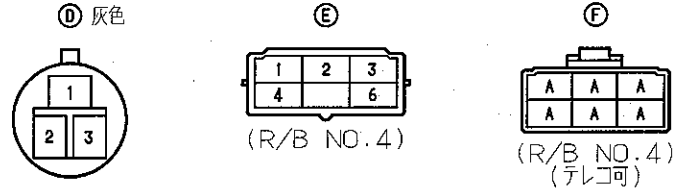
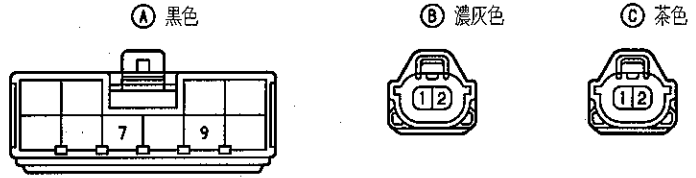
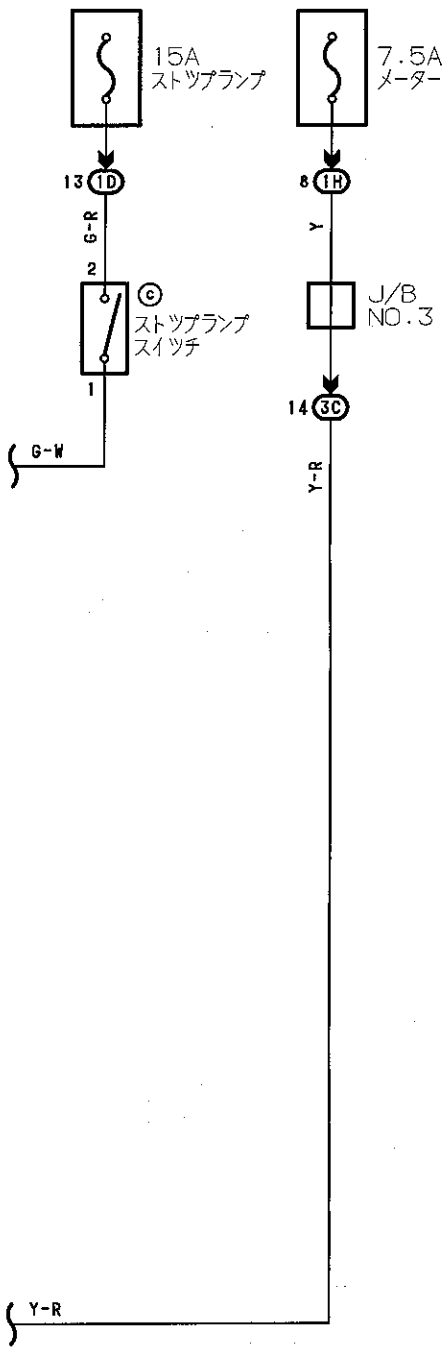

① 濃灰色



⑤ 濃灰色



④ 黑色



⑧ 黑色



⑦ 黑色

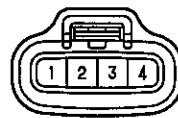

② 黑色

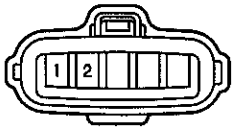

③

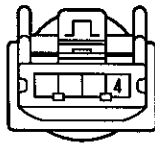

⑥

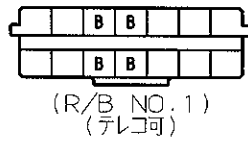

⑨ 灰色

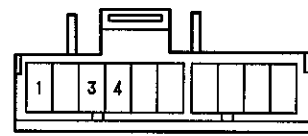

⑩ 青色

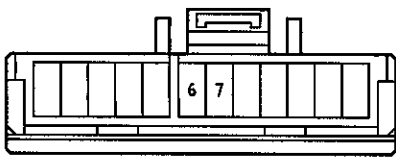

⑪

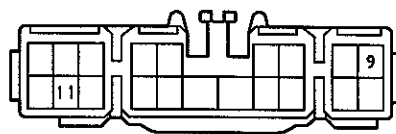

⑫ 灰色

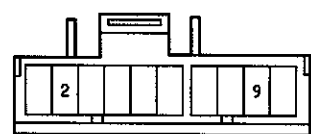

⑬ 青色

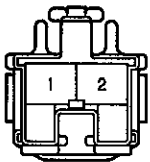

⑬C

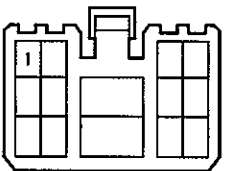

⑬D

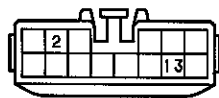

⑬E

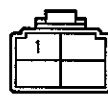

⑬F

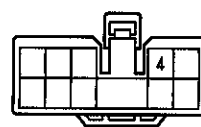

⑬G



⑬H 青色

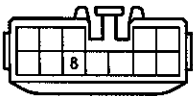

⑬A 茶色



⑬B 黑色

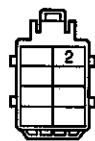

⑬C

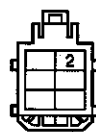

⑬C 青色

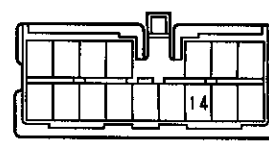

⑬A

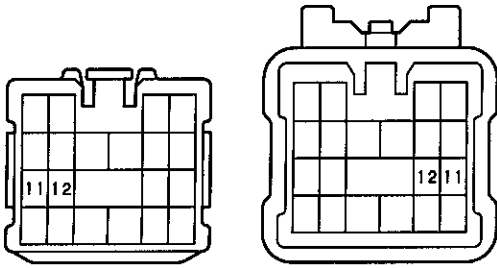
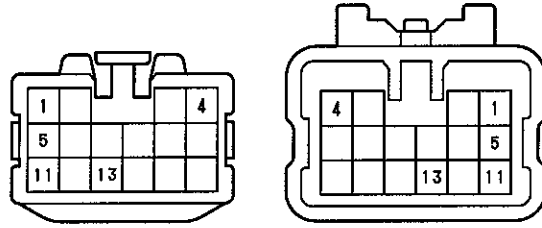
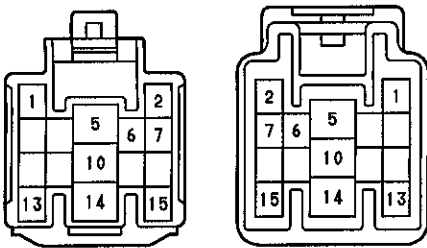
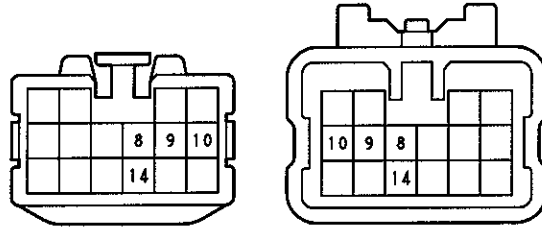
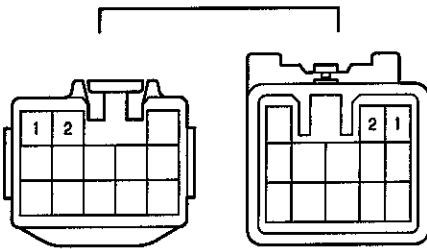
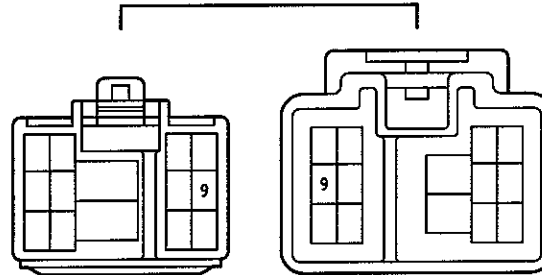

III

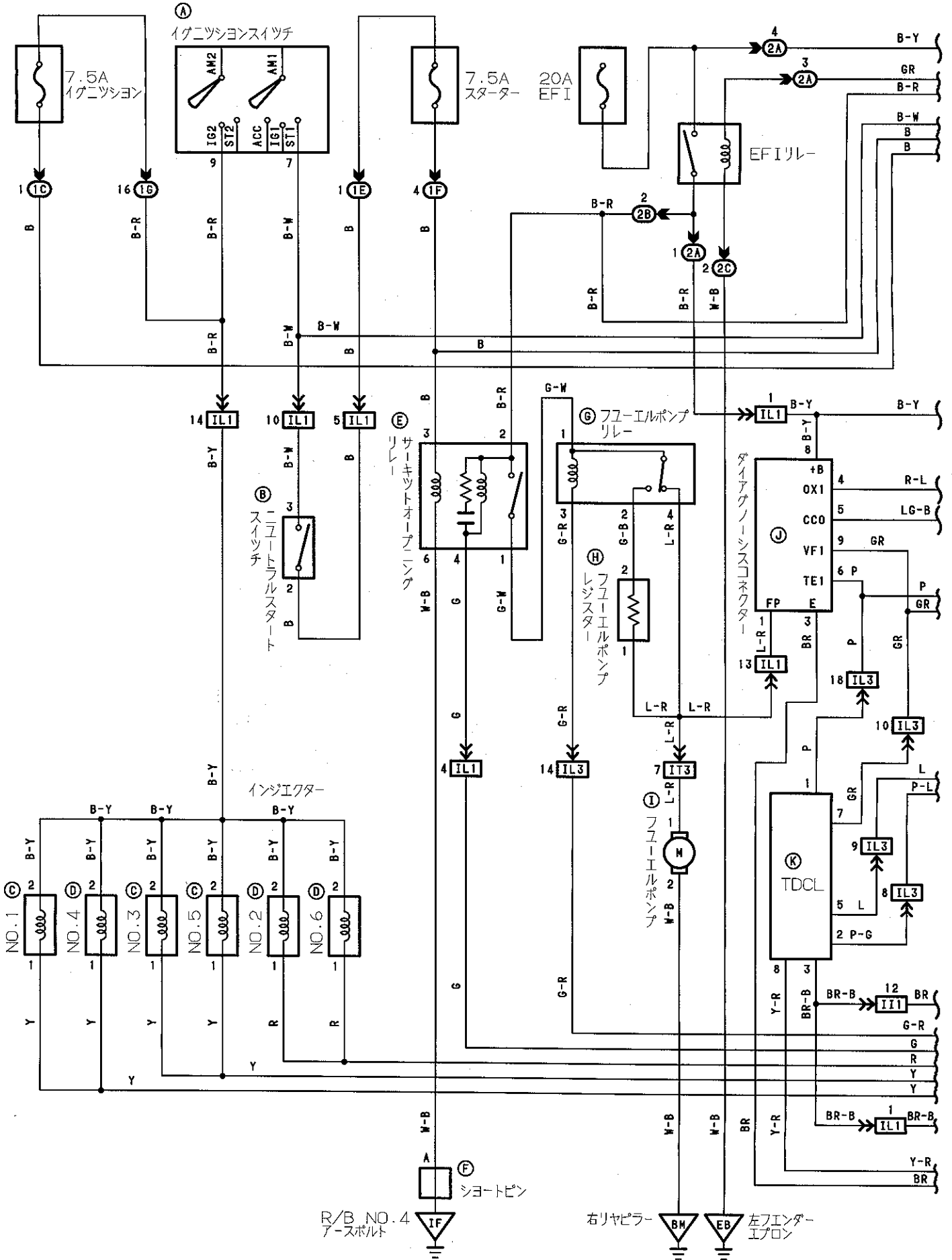
IK1 IM1 IM3

IL1 濃灰色

IL2 濃灰色

IM2

IT3



R/B NO.4
アースボルト



右リヤペラー



左エンダー
エプロン

エンジンコントロール
コンピューター

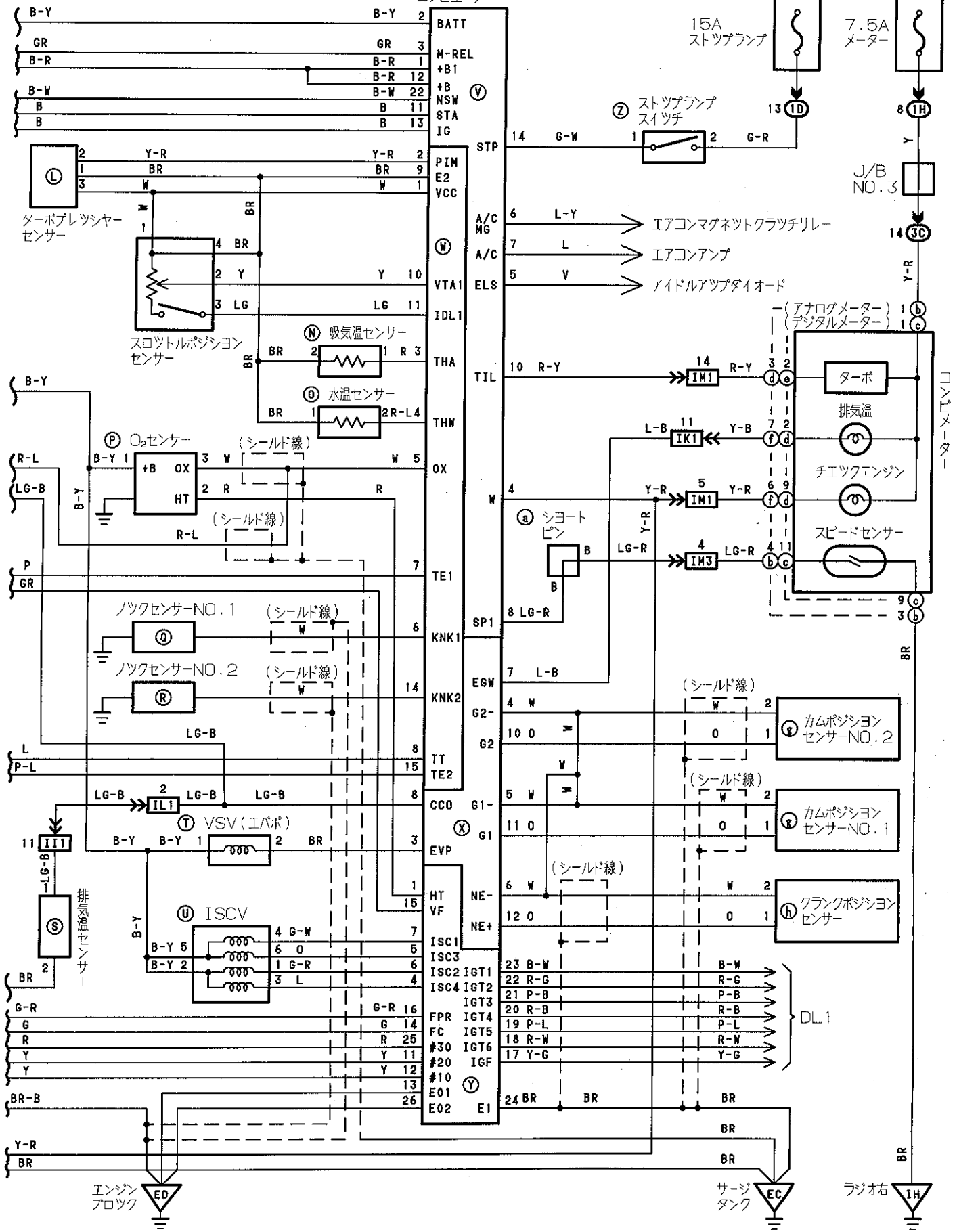



Ⓐ 黒色

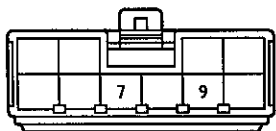

Ⓑ 灰色

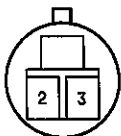

Ⓒ 灰色



Ⓓ 茶色



Ⓔ



(R/B NO. 4)

Ⓕ



(R/B NO. 4)
(テレコ可)

Ⓖ 濃灰色

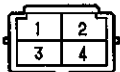

(R/B NO. 1)

Ⓕ 濃灰色



Ⓖ 濃灰色又は灰色



Ⓖ 濃灰色

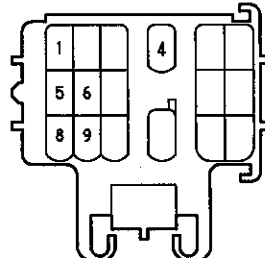

Ⓖ 濃灰色

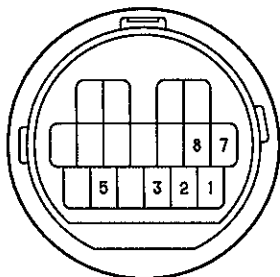

Ⓖ 黒色

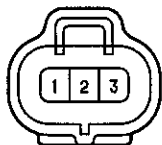

Ⓖ 黒色



Ⓖ 濃灰色



Ⓖ 濃緑色



Ⓖ 濃灰色



Ⓖ 濃灰色



Ⓖ 濃灰色



Ⓖ 青色



Ⓖ 灰色



Ⓖ 濃灰色

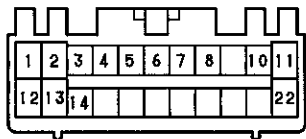

Ⓖ 濃灰色

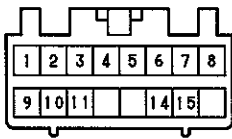

Ⓖ 濃灰色

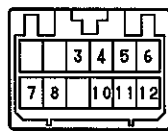

Ⓖ 濃灰色

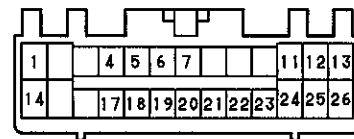

Ⓖ 青色

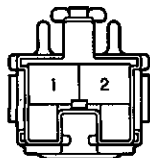

Ⓖ

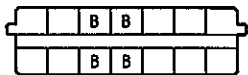

(R/B NO. 1)
(テレコ可)

Ⓖ 灰色

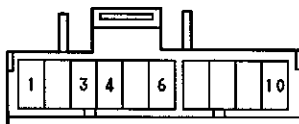

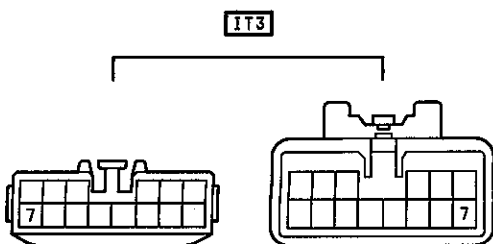
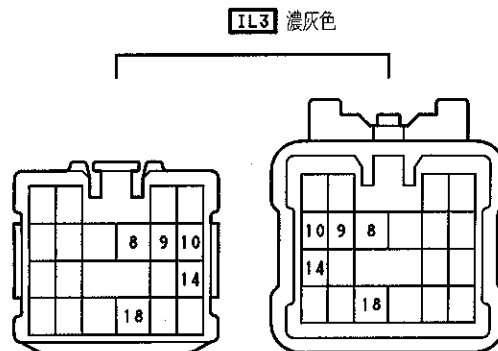
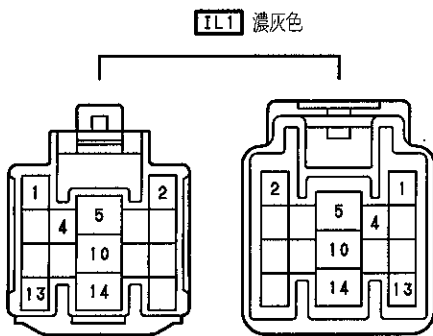
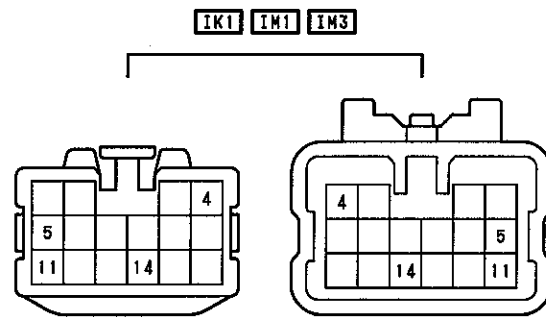
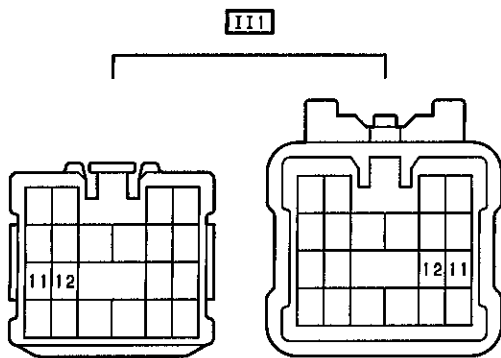
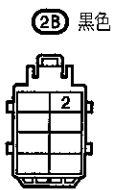
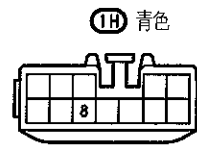
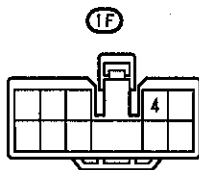
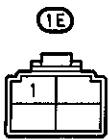
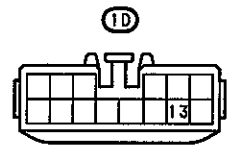
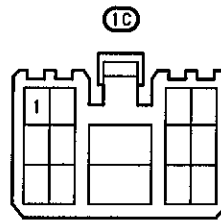
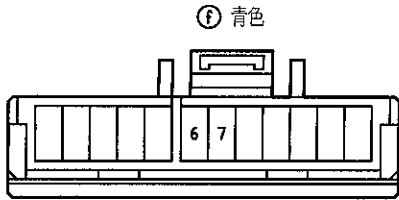
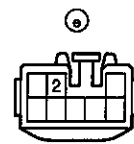
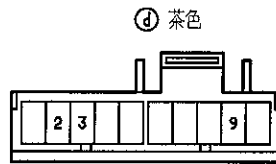
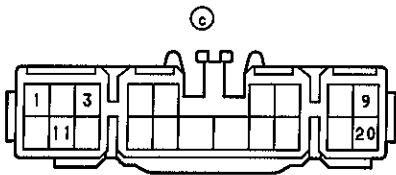

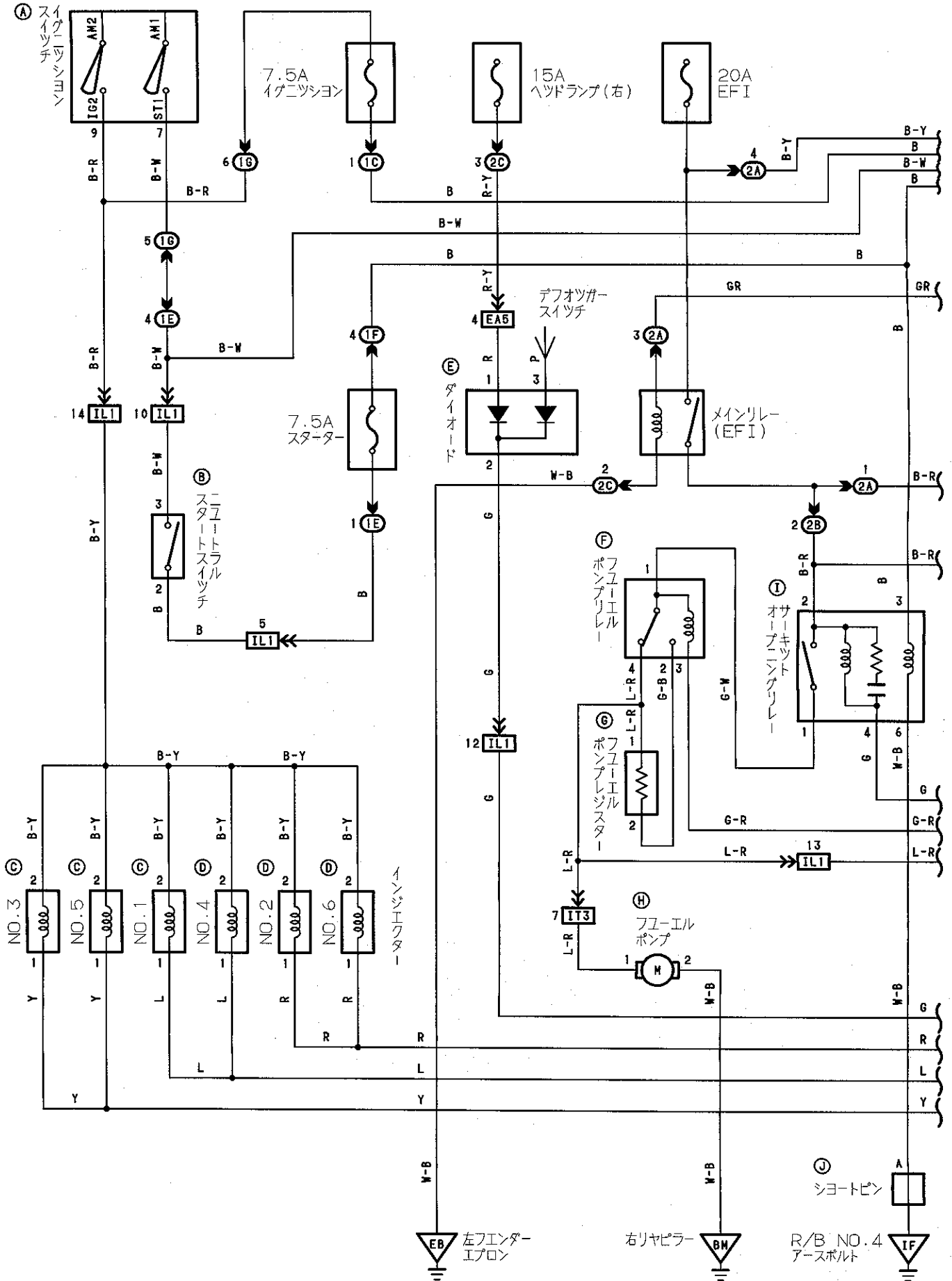

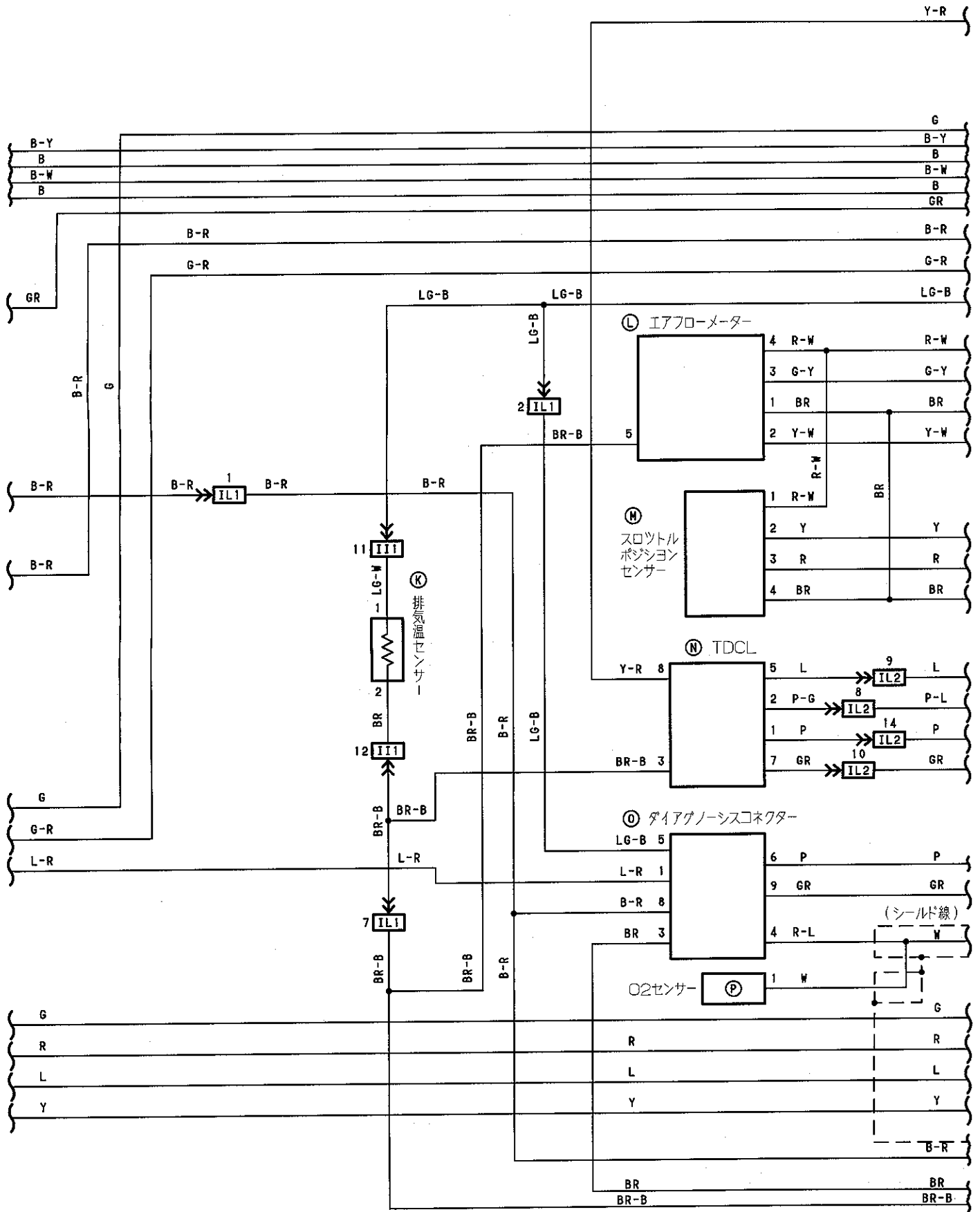

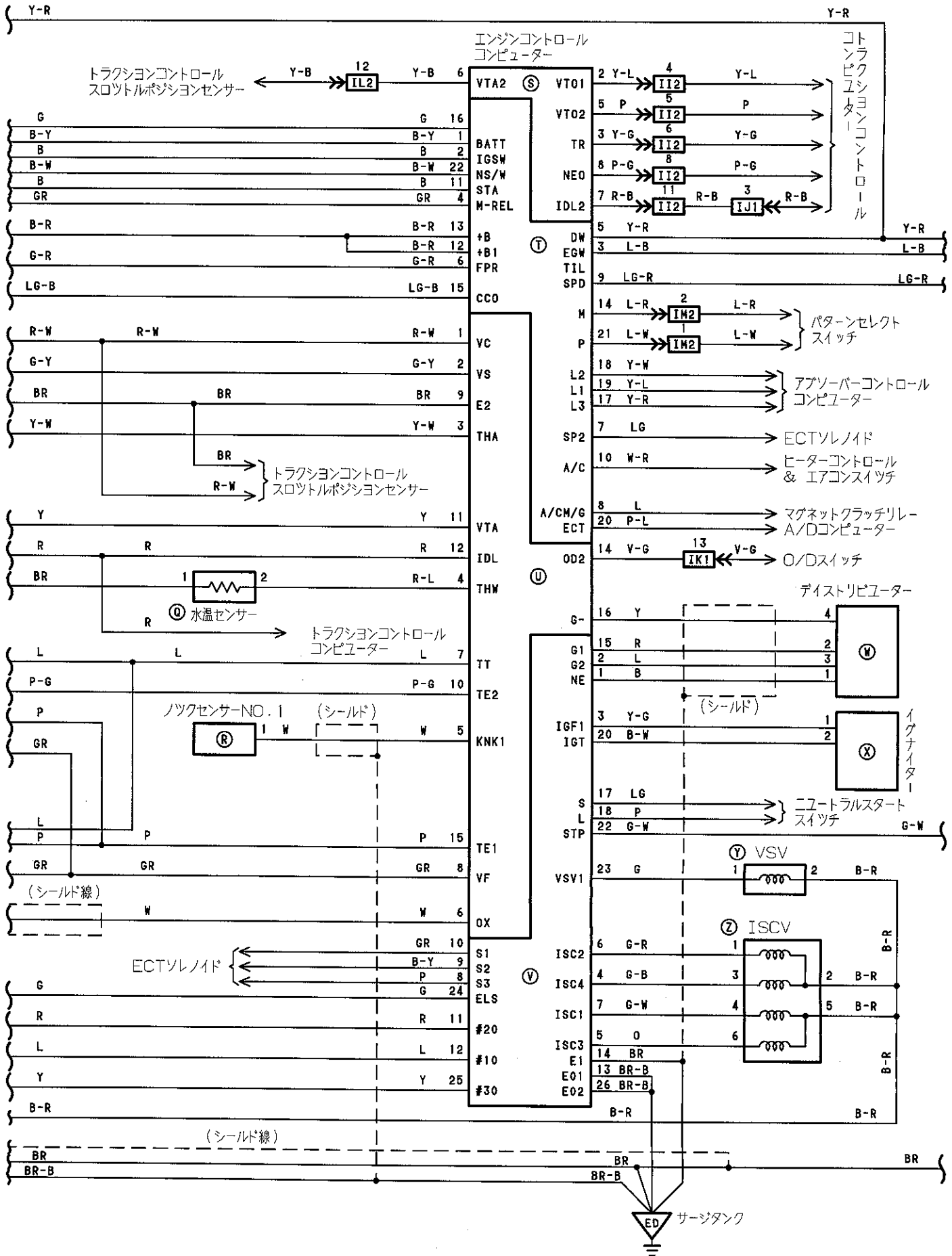

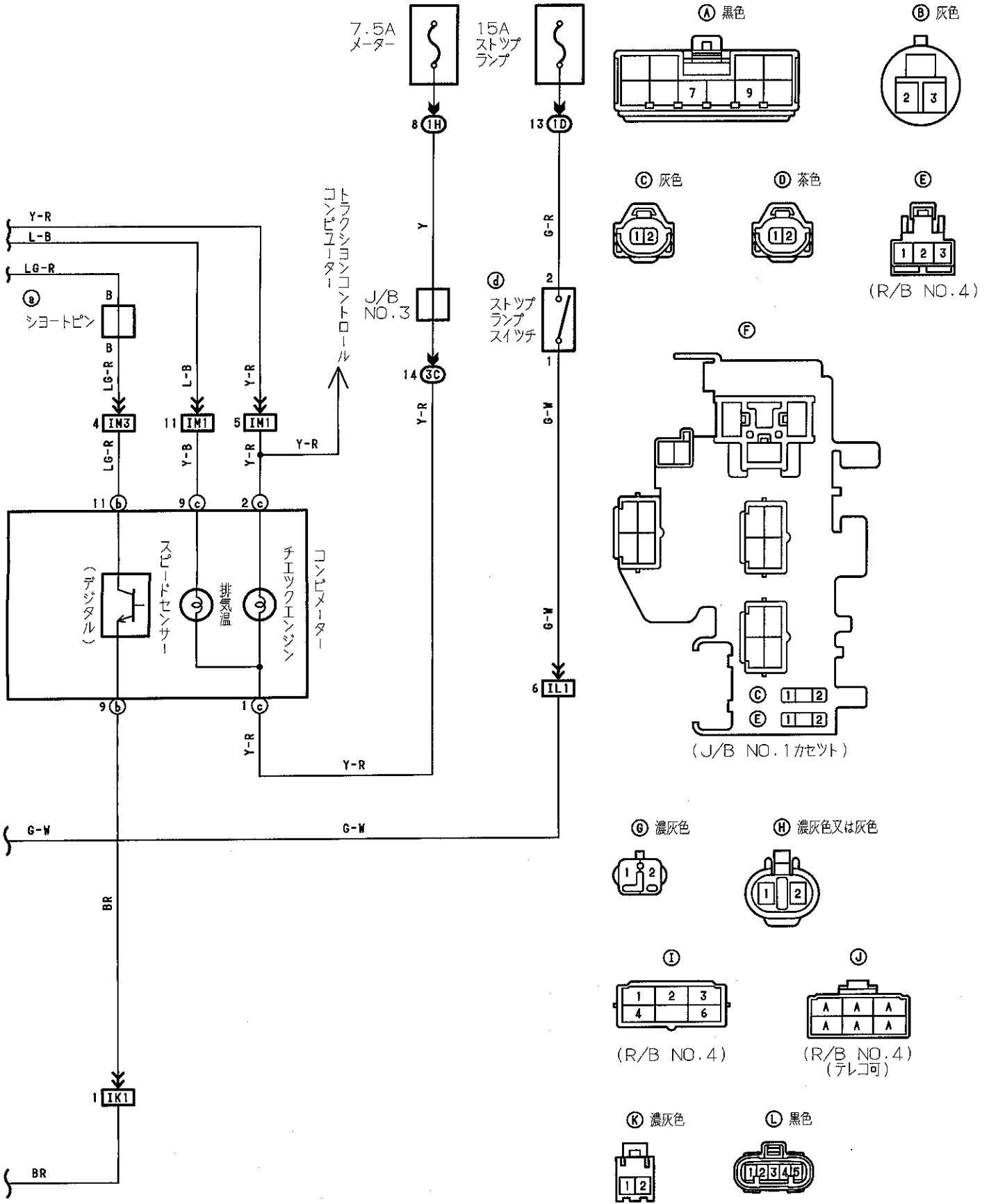

Ⓜ 黒色

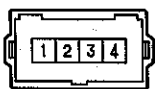

Ⓝ 濃灰色

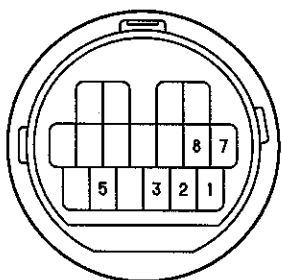

ⓓ 濃灰色

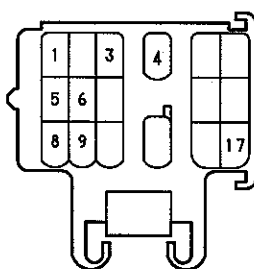

Ⓟ 濃灰色



Ⓠ 濃緑色



Ⓡ 濃灰色



Ⓢ 濃灰色



Ⓣ 濃灰色

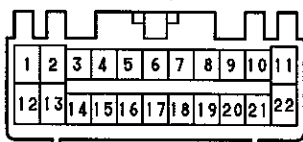

Ⓤ 濃灰色

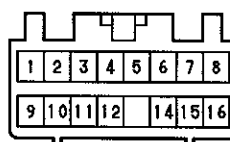

Ⓥ 濃灰色

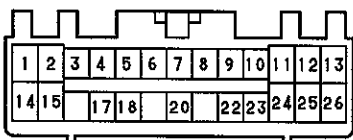

Ⓦ 黒色

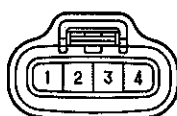

Ⓧ 黒色

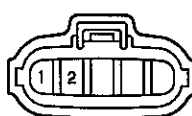

Ⓨ 茶色



Ⓩ 灰色



ⓐ

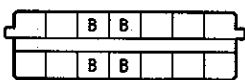

(J/B NO.1)
(テレコ可)

ⓑ

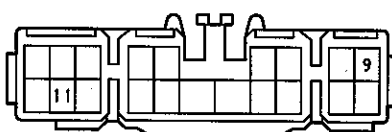

ⓓ 茶色

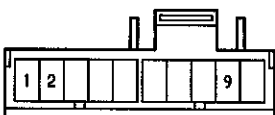

ⓔ 青色

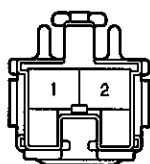

ⓕ

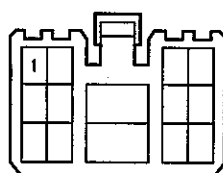

ⓖ

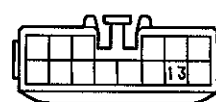

ⓗ



ⓓ

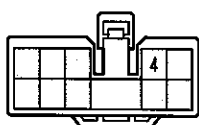

ⓓ

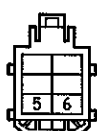

ⓓ 青色

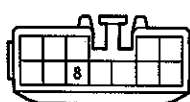

ⓓA 茶色



ⓓB 黒色

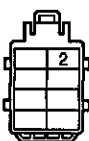

ⓓC

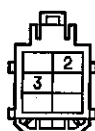

ⓓC 青色

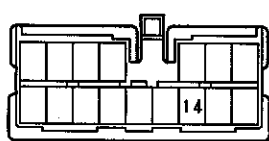

EA5 灰色

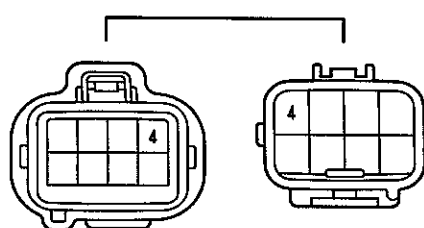

III

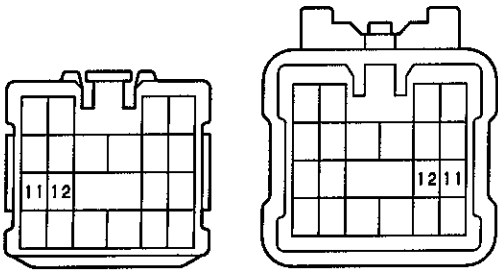

II2 青色

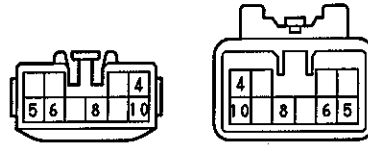

IJI だいだい色

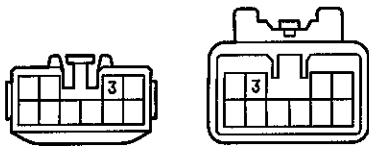

IK1

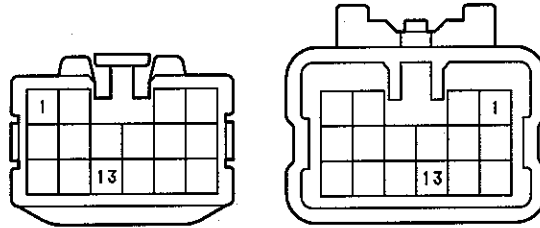

IL1 濃灰色

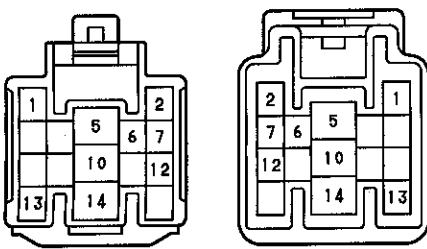

IL2 濃灰色

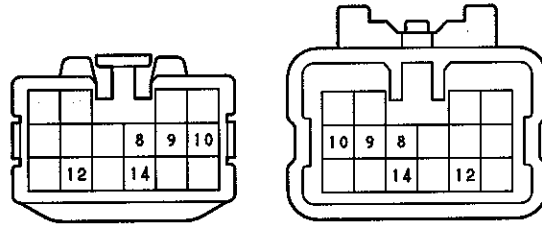

IM1

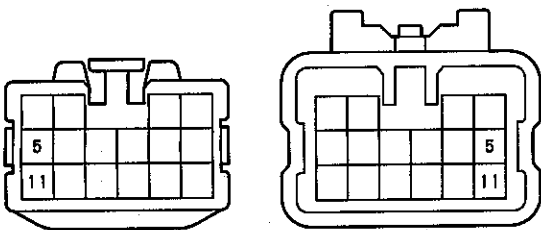

IN2

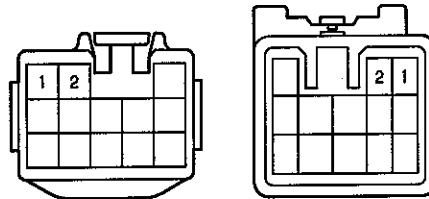

IM3

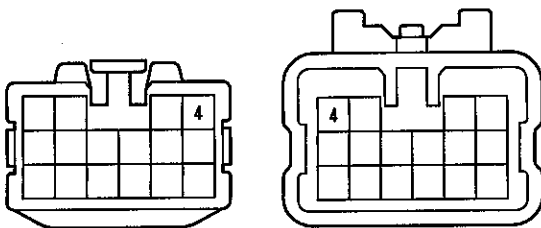

IT3

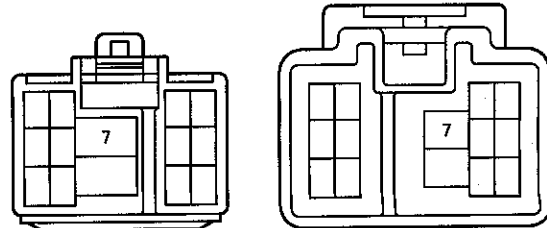

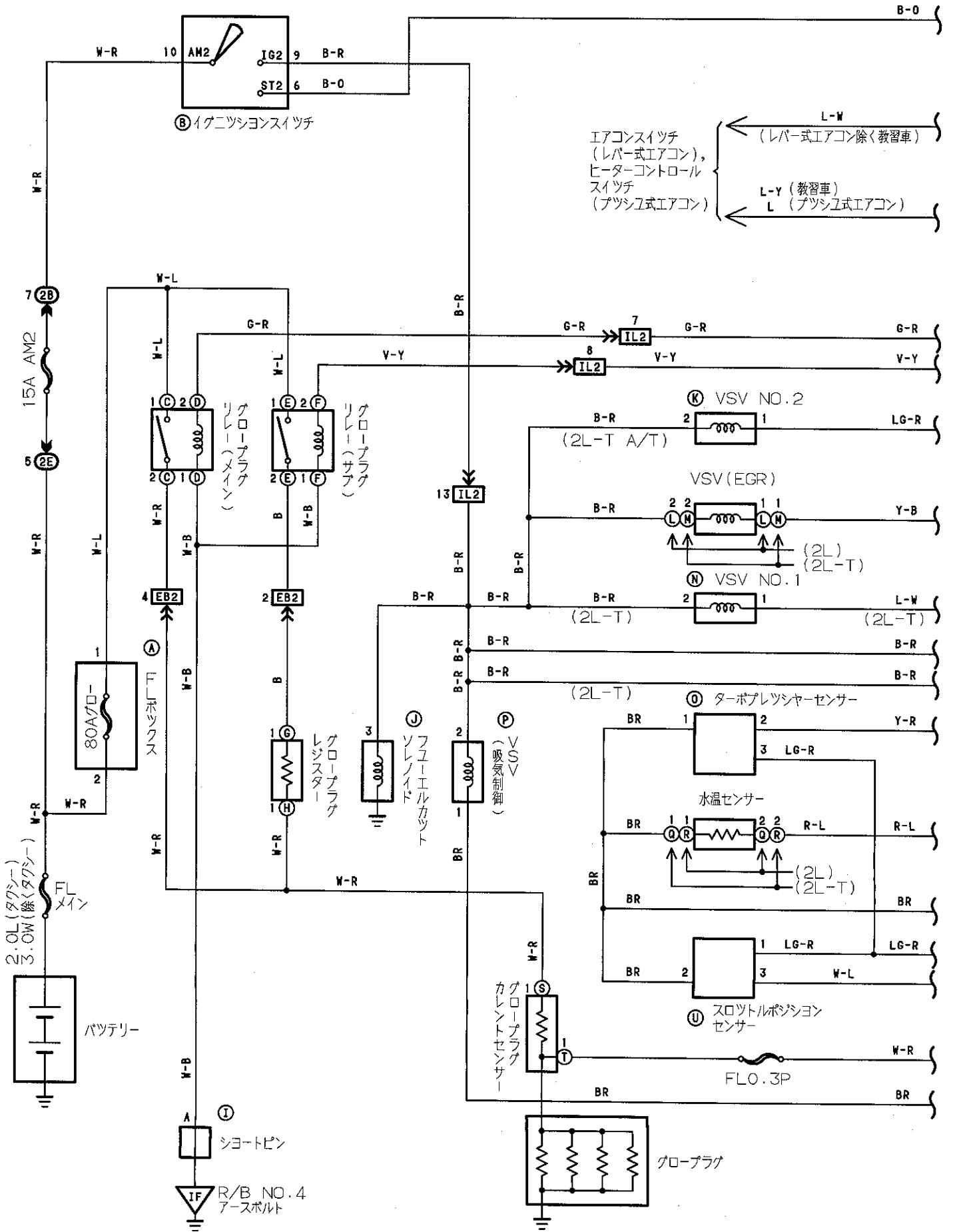

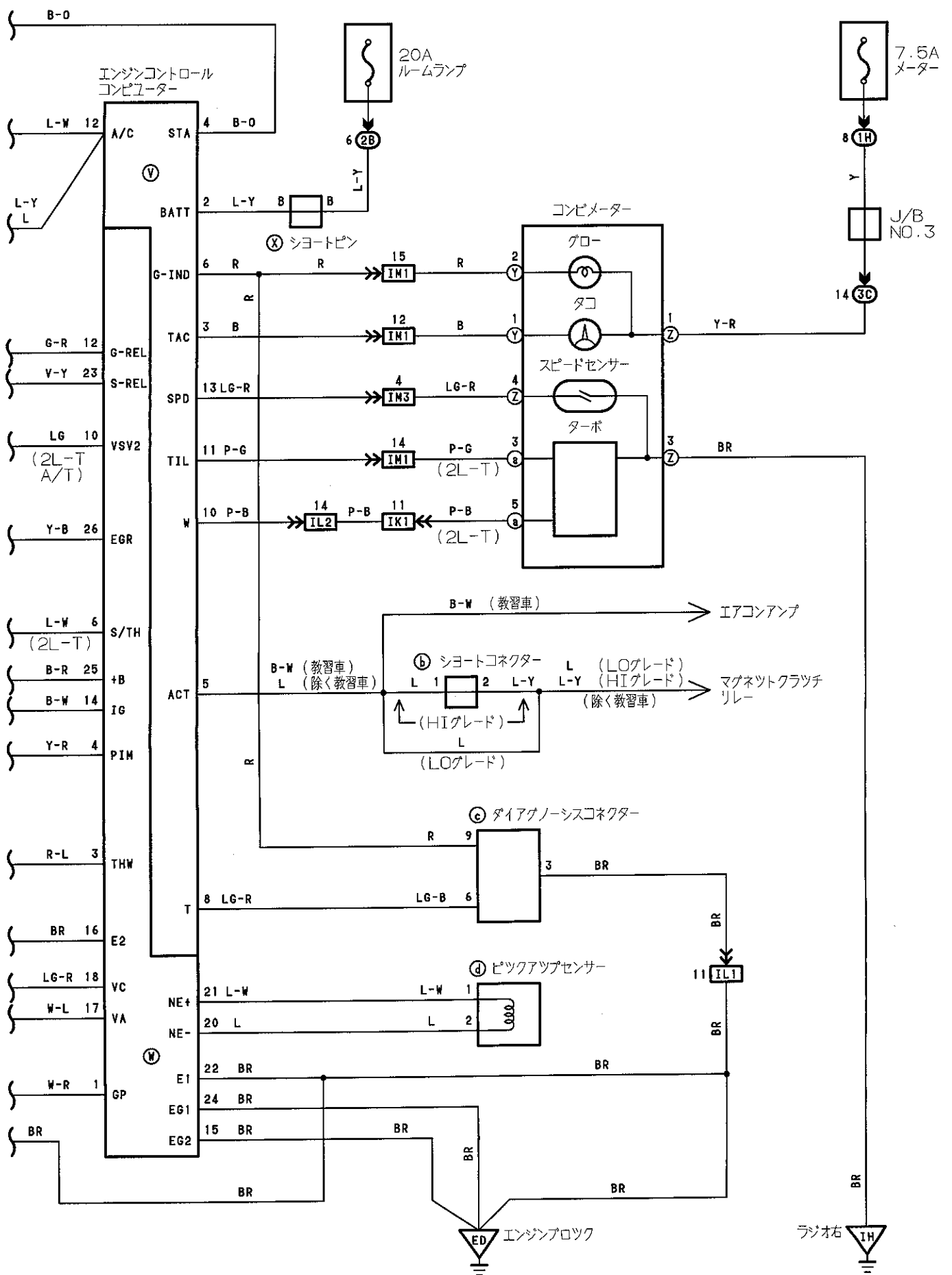

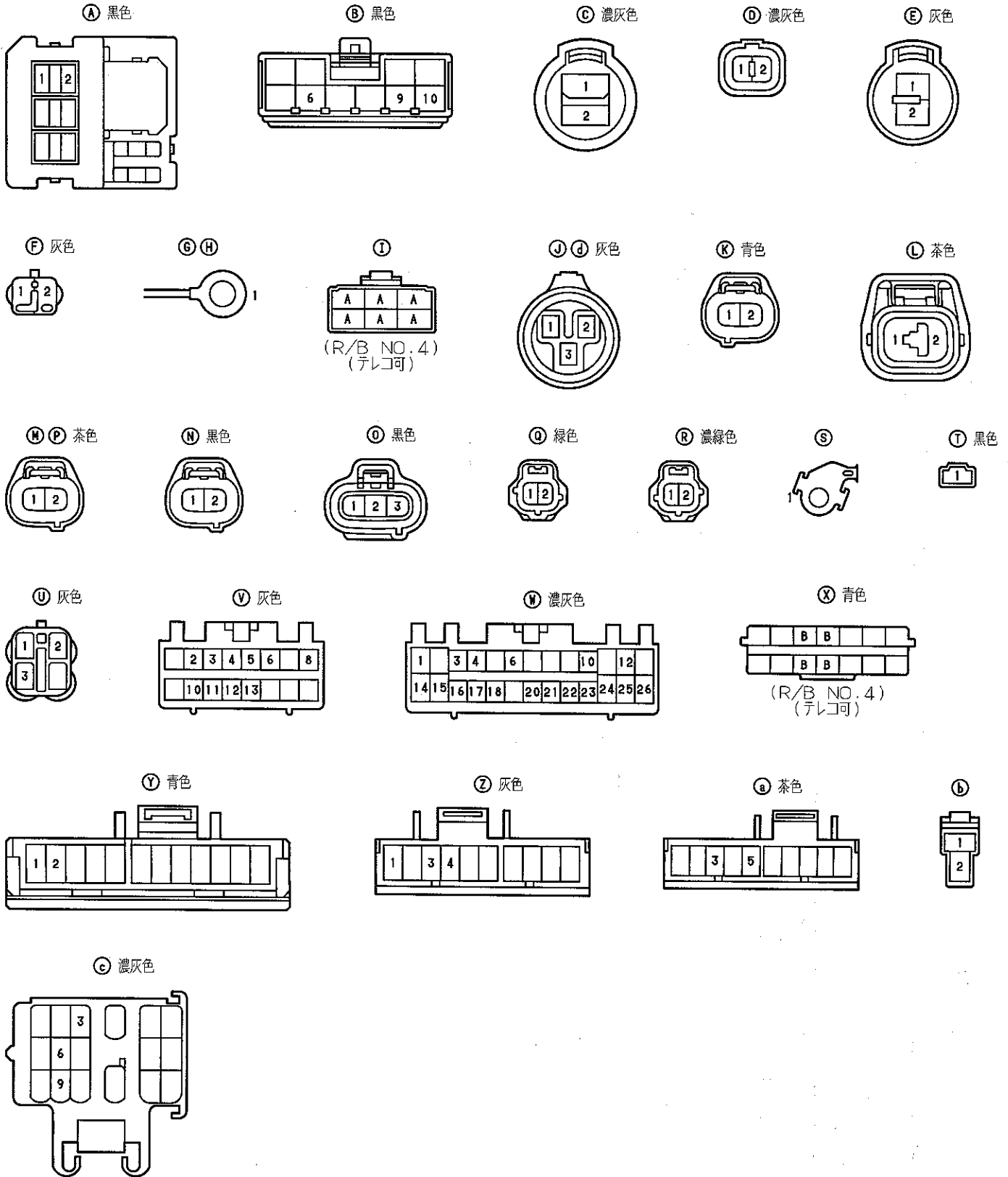

1H 青色

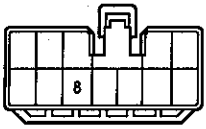

2B 黑色

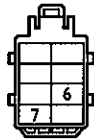

2E 黑色

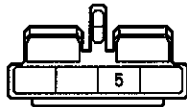

3D 青色

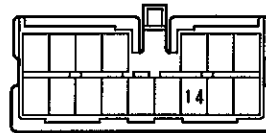

EB2 黑色

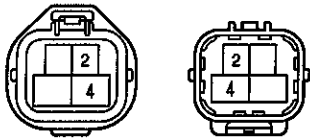

IK1 IM1 IM3

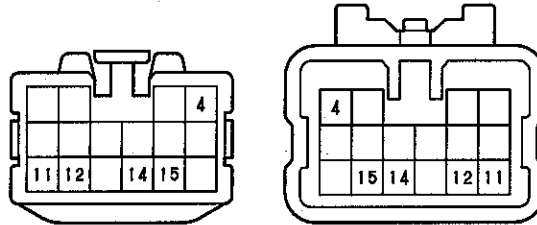

IL1 濃灰色

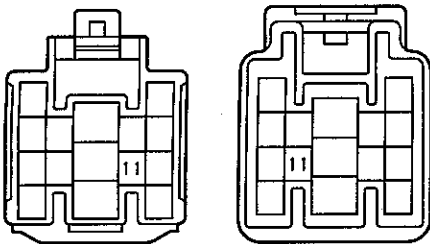

IL2 濃灰色

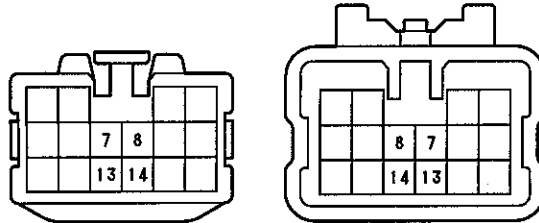

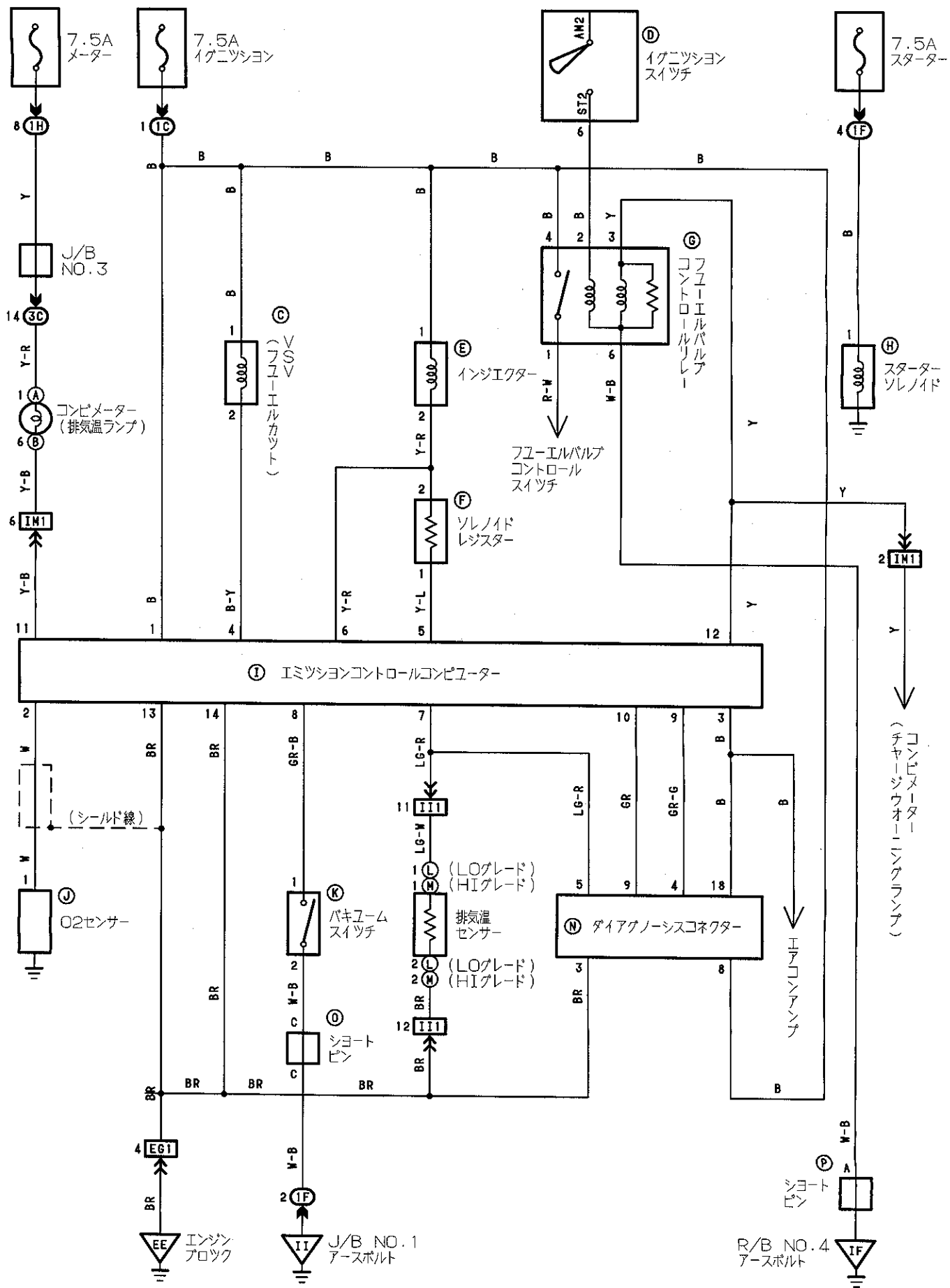



Ⓐ 灰色

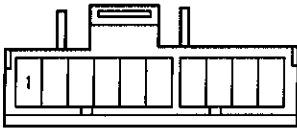

Ⓑ 青色

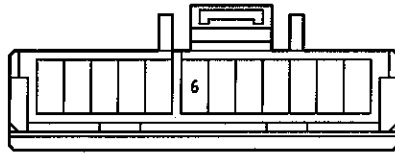

Ⓒ 緑色

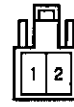

Ⓓ 黒色

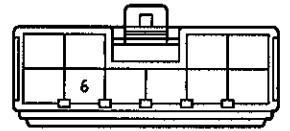

Ⓔ 黒色

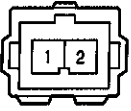

Ⓕ 灰色



Ⓖ

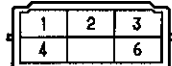

(R/B NO.4)

Ⓗ



Ⓘ 灰色



Ⓙ 濃灰色



Ⓚ 灰色



Ⓛ 灰色

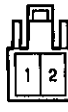

Ⓜ 濃灰色



Ⓝ 濃灰色

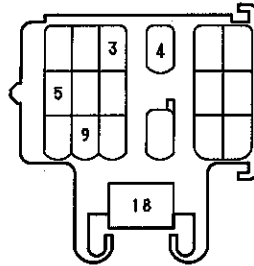

Ⓟ

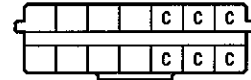

(R/B NO.1)
(テレコ可)

Ⓟ



(R/B NO.1)
(テレコ可)

Ⓠ

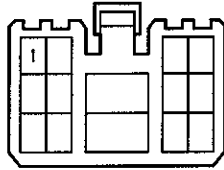

Ⓡ 青色

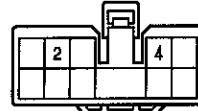

Ⓢ



Ⓣ 青色

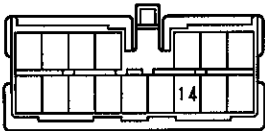

EG1 灰色

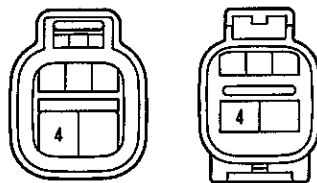

III

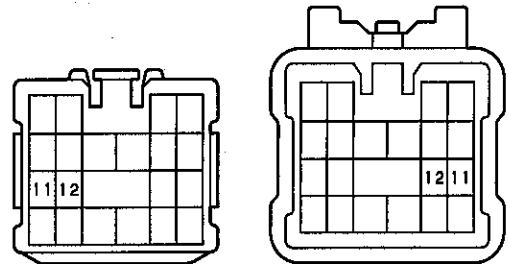

IMI

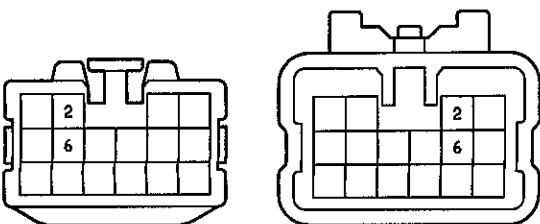

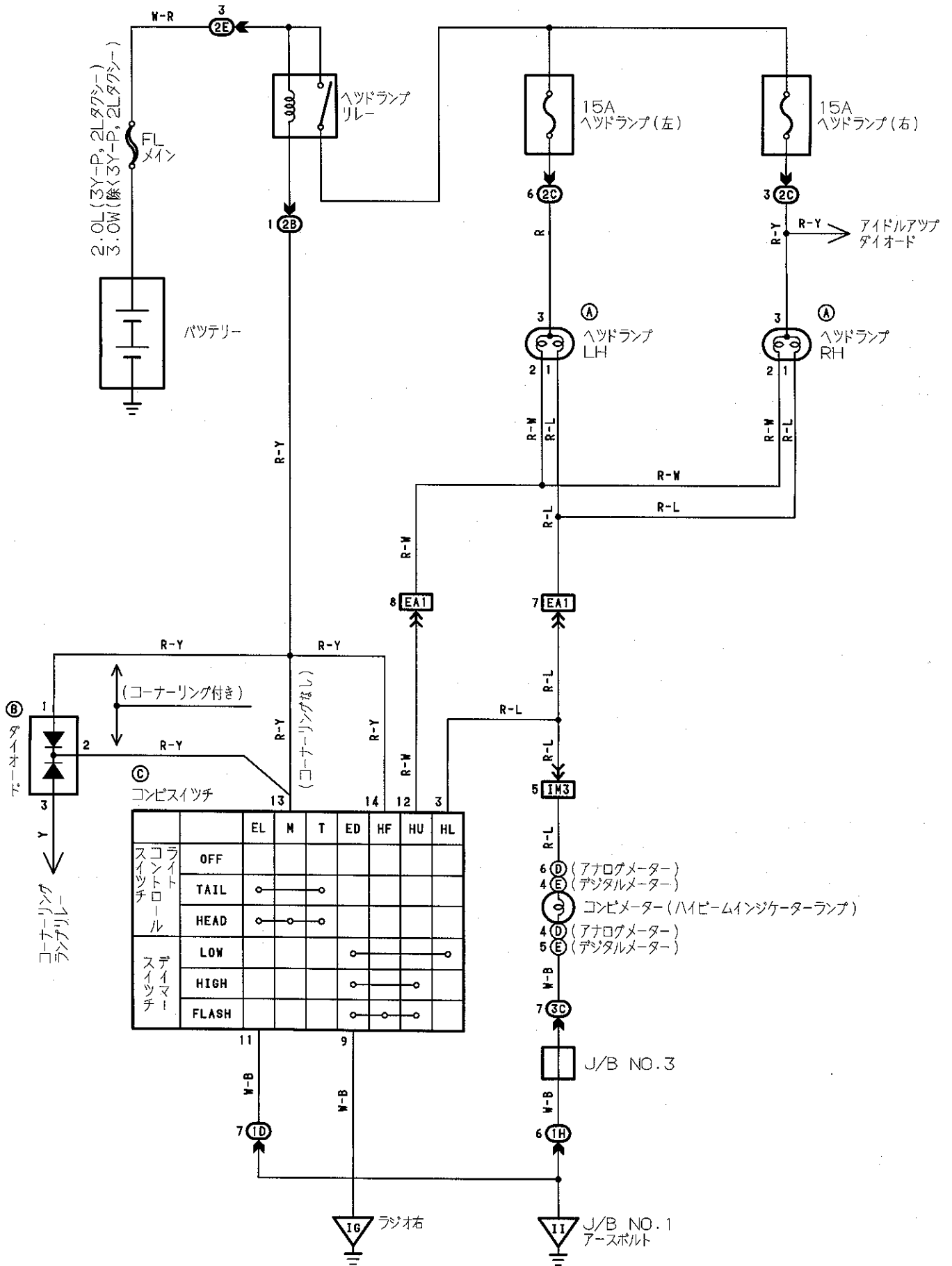

Ⓐ 灰色



Ⓑ

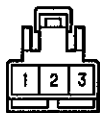

Ⓒ 黒色

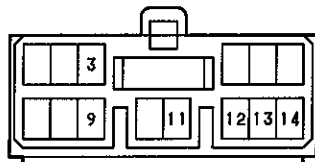

Ⓓ 茶色

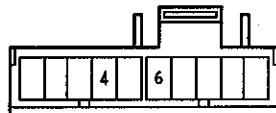

Ⓔ

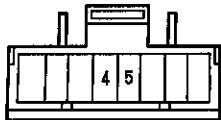

1D

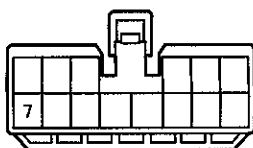

1H 青色

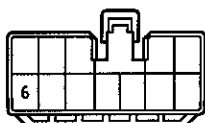

2B 黒色



2C

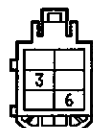

2E 黒色

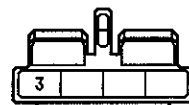

3C 青色

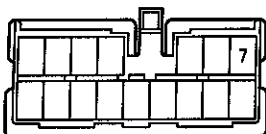

EA1 灰色

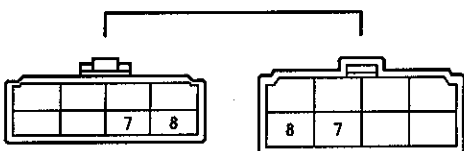

IM3

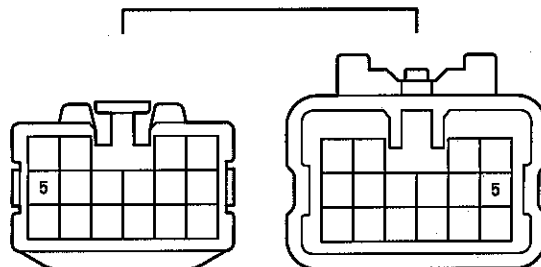

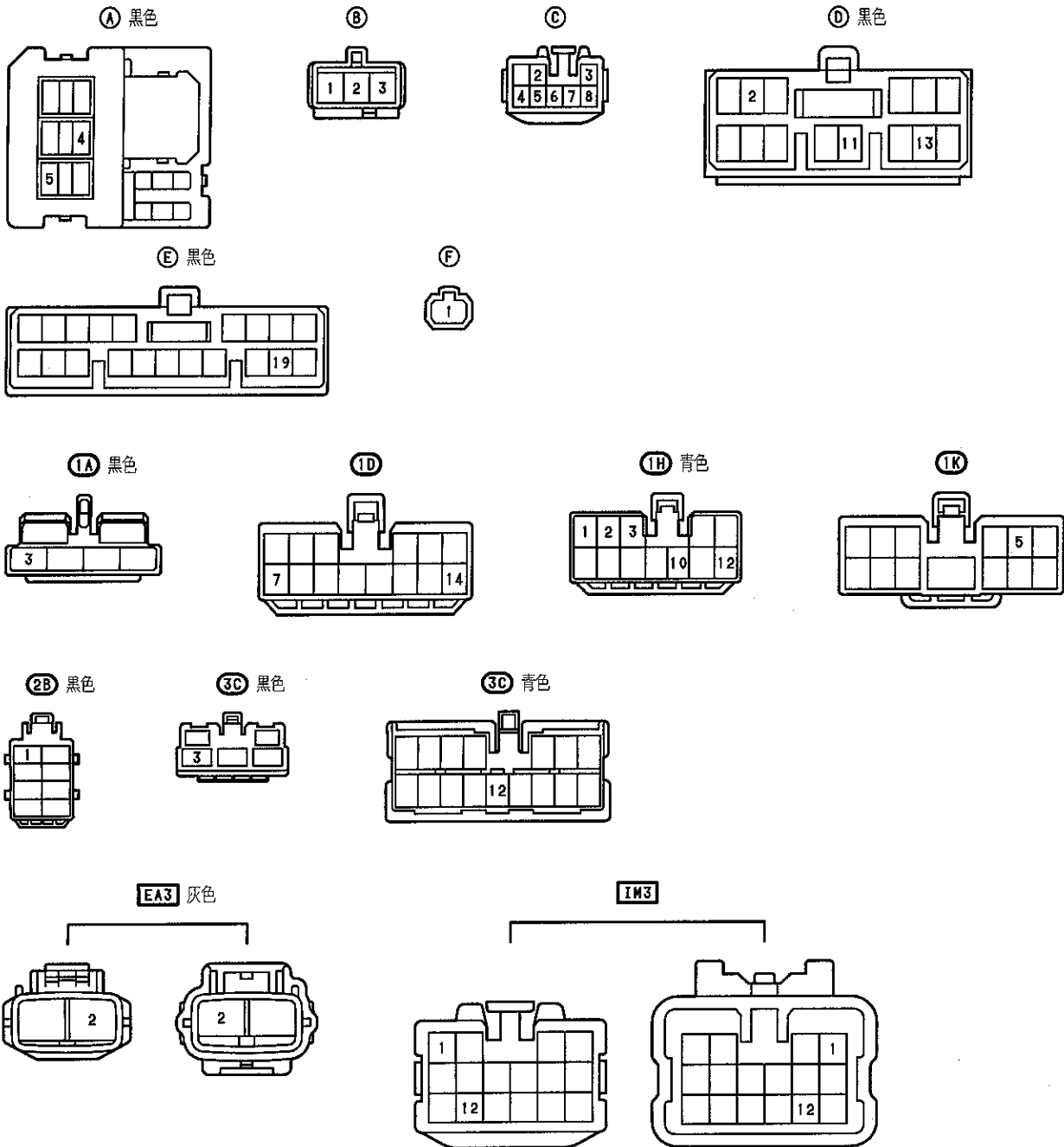

□ マークII Rグレード及び教習車及びタクシー
 △ 除くマークII Rグレード及び教習車及びタクシー

⊙ ランプフェイリアなし
 ▲ ランプフェイリア付き

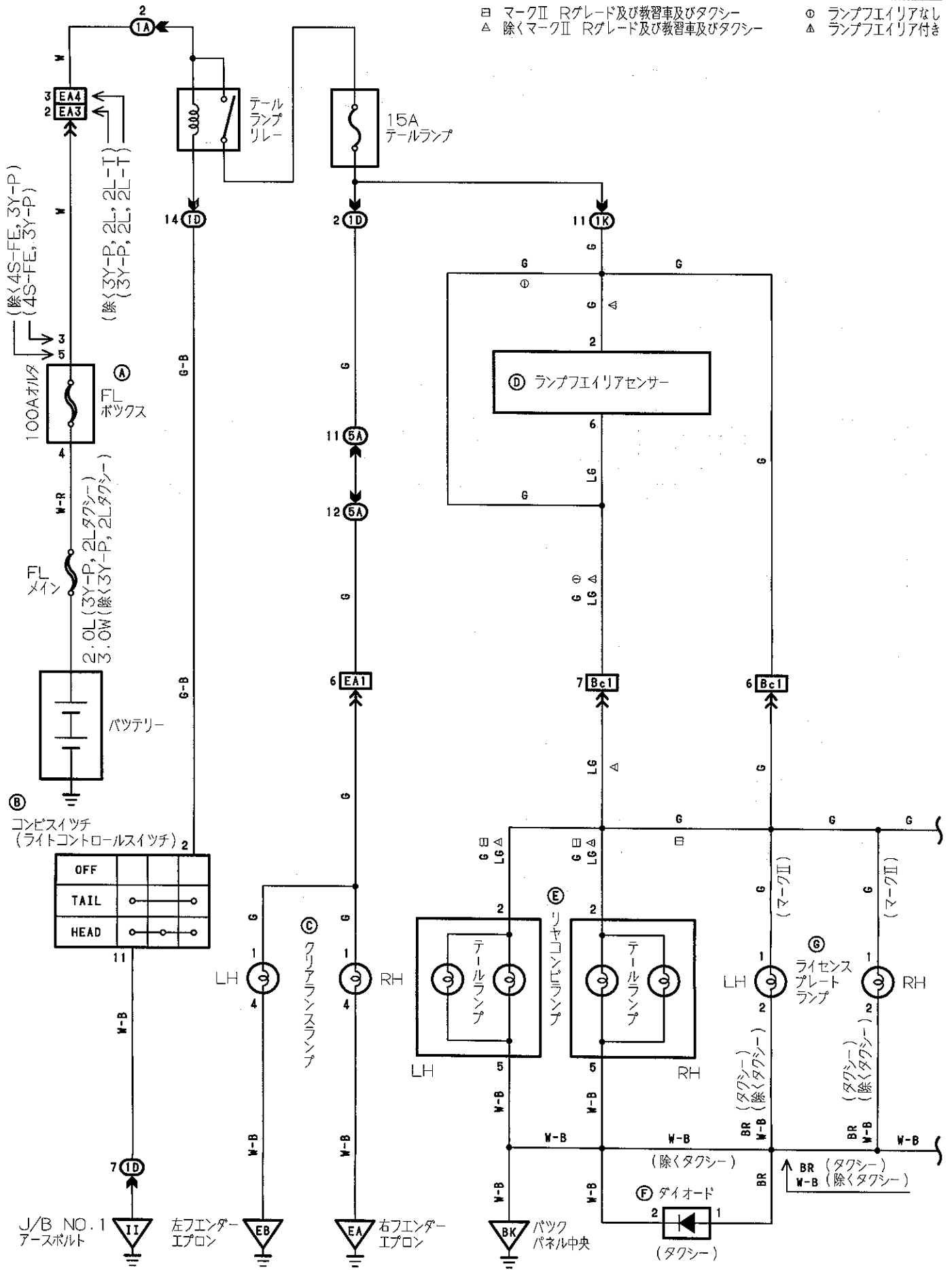

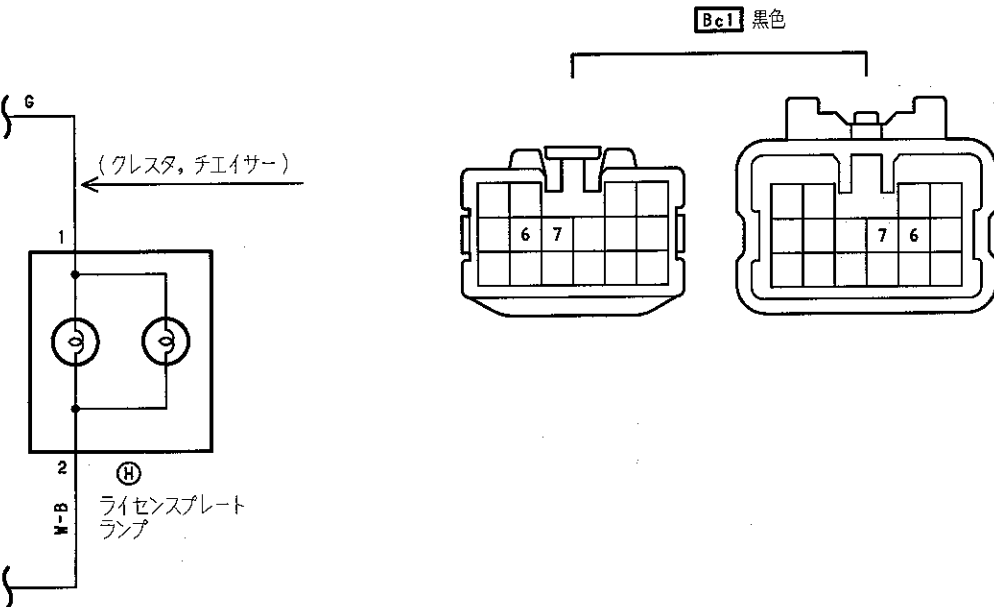
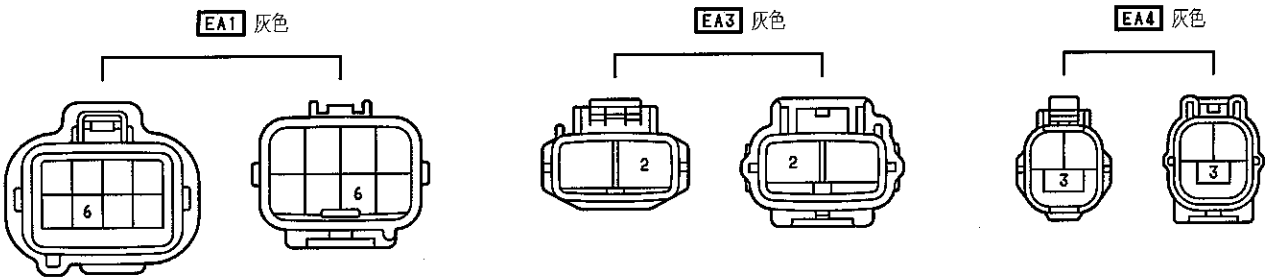
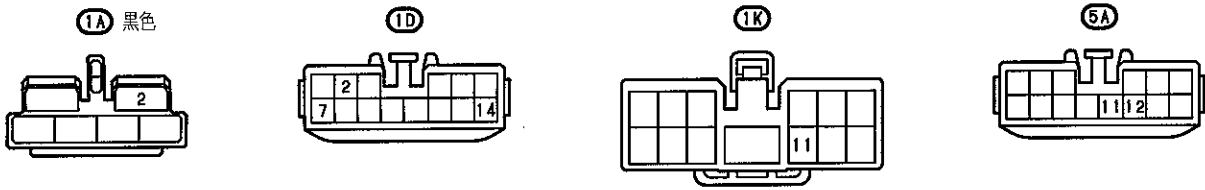
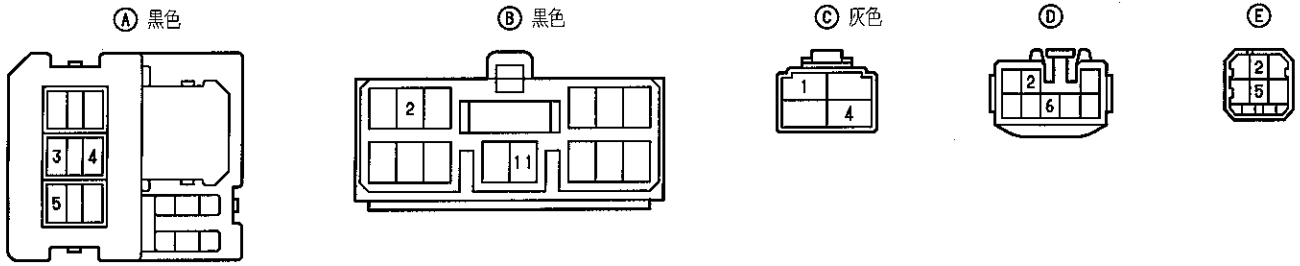

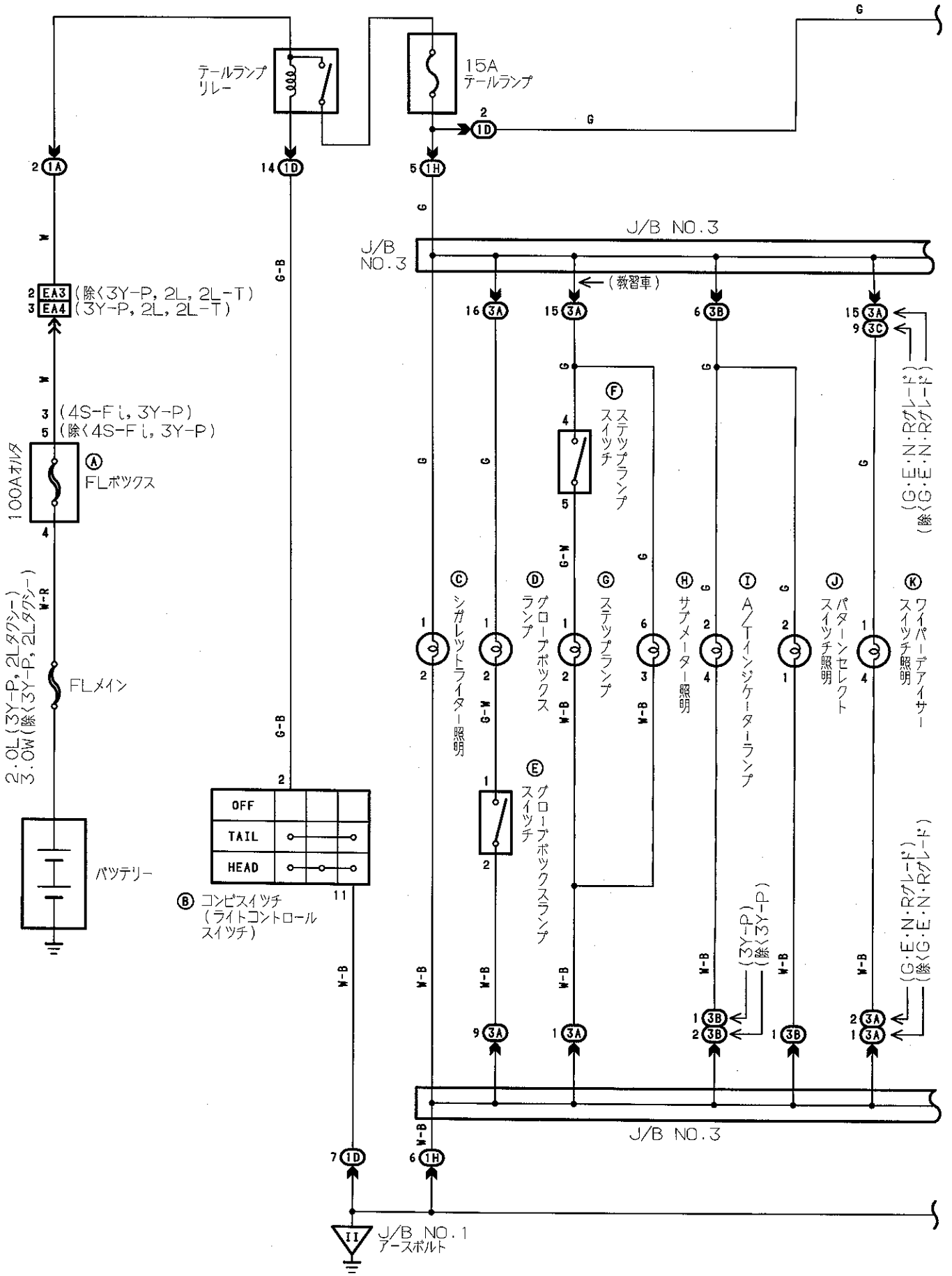

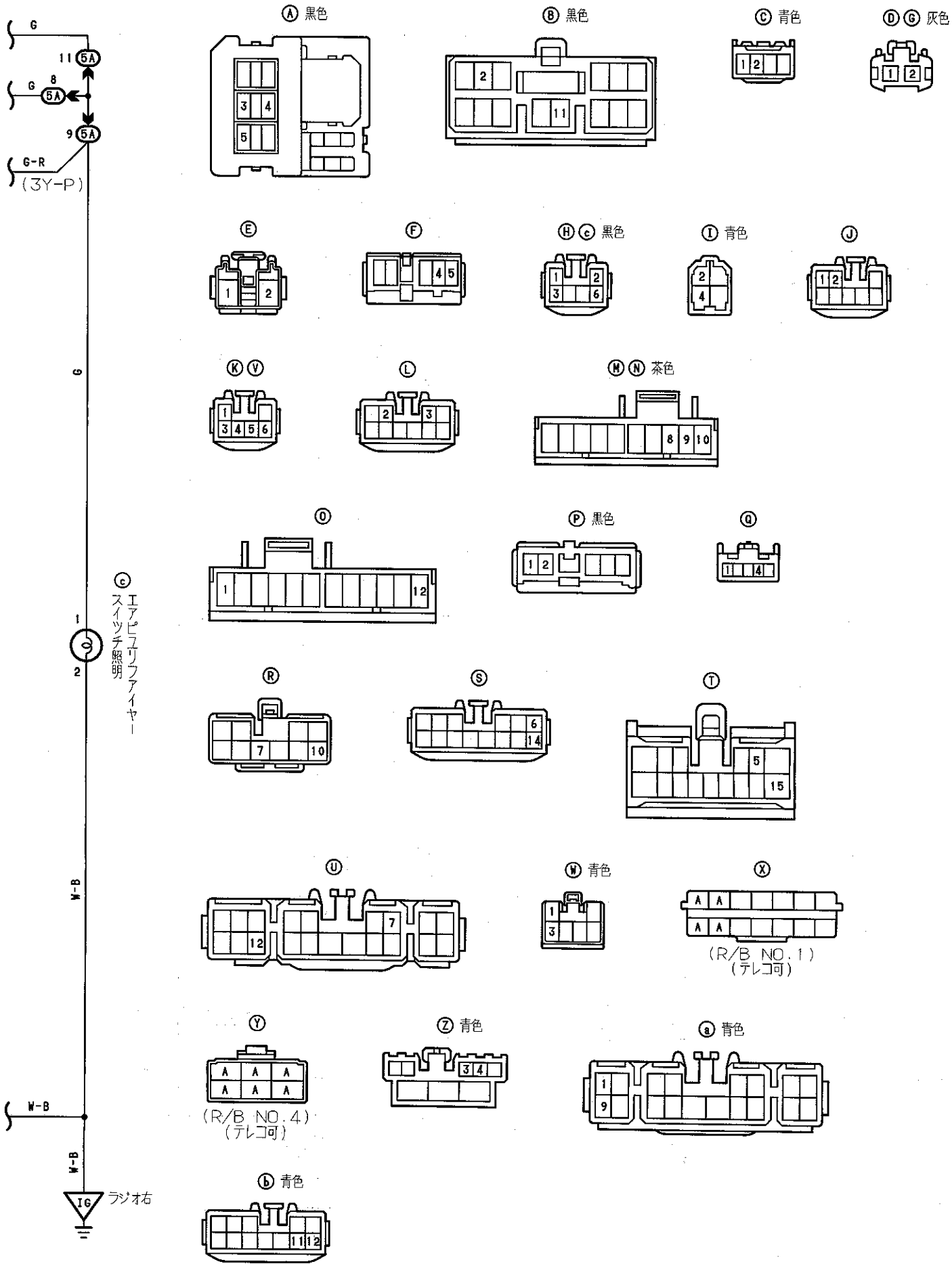

1A 黒色

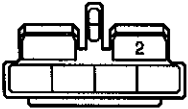

1D 5A

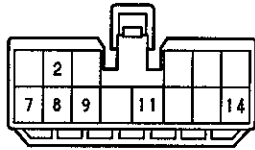

1H 青色

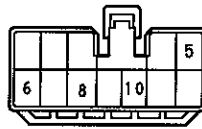

3A

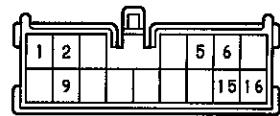

3B だいだい色

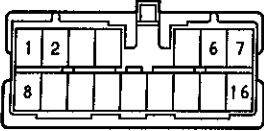

3C 青色

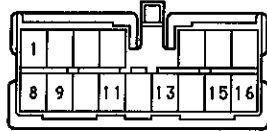

EA3 灰色

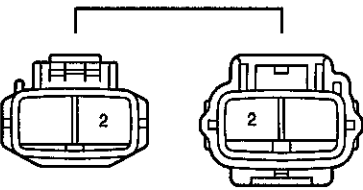

EA4 灰色

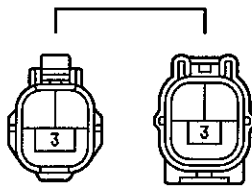

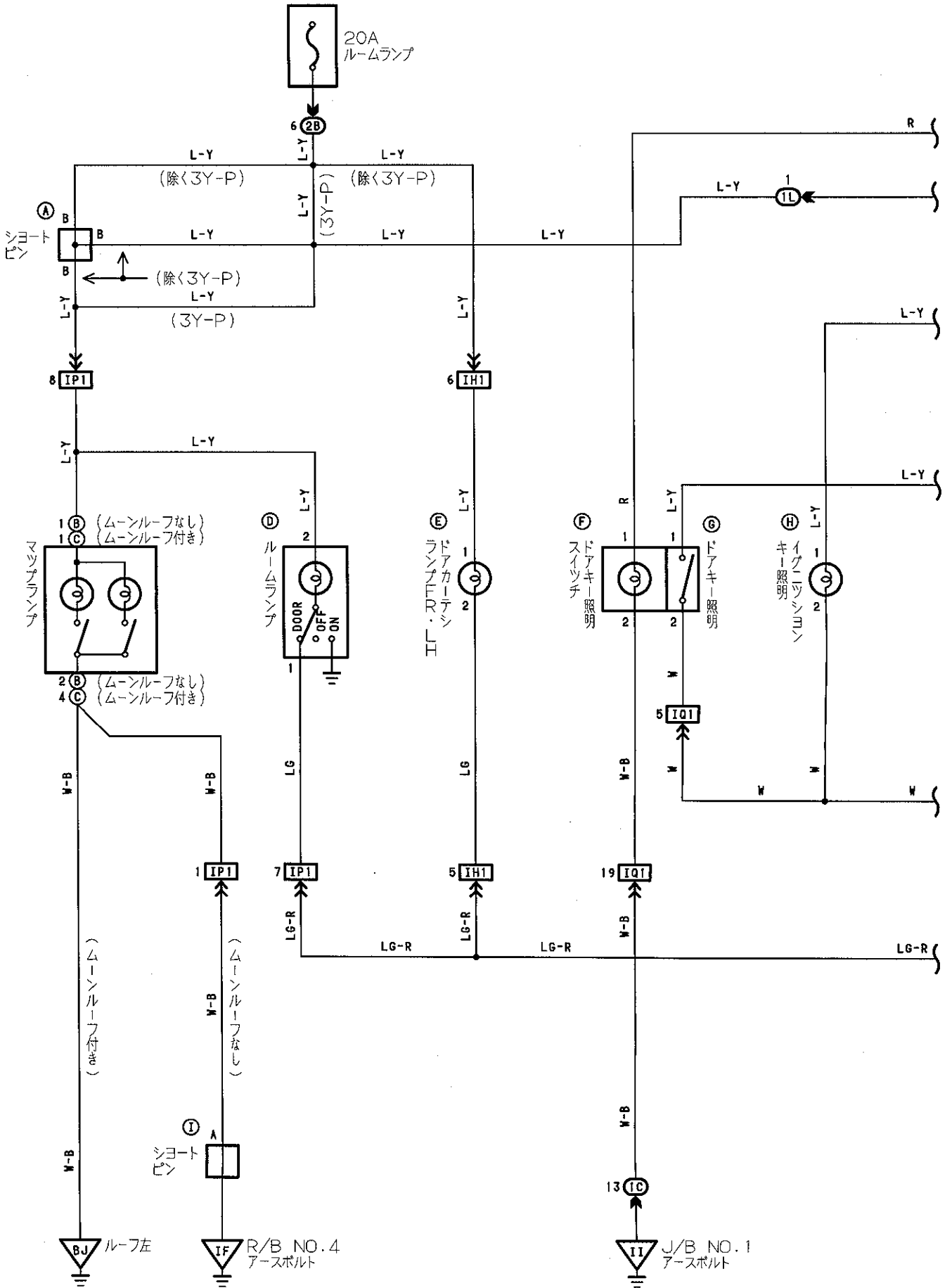

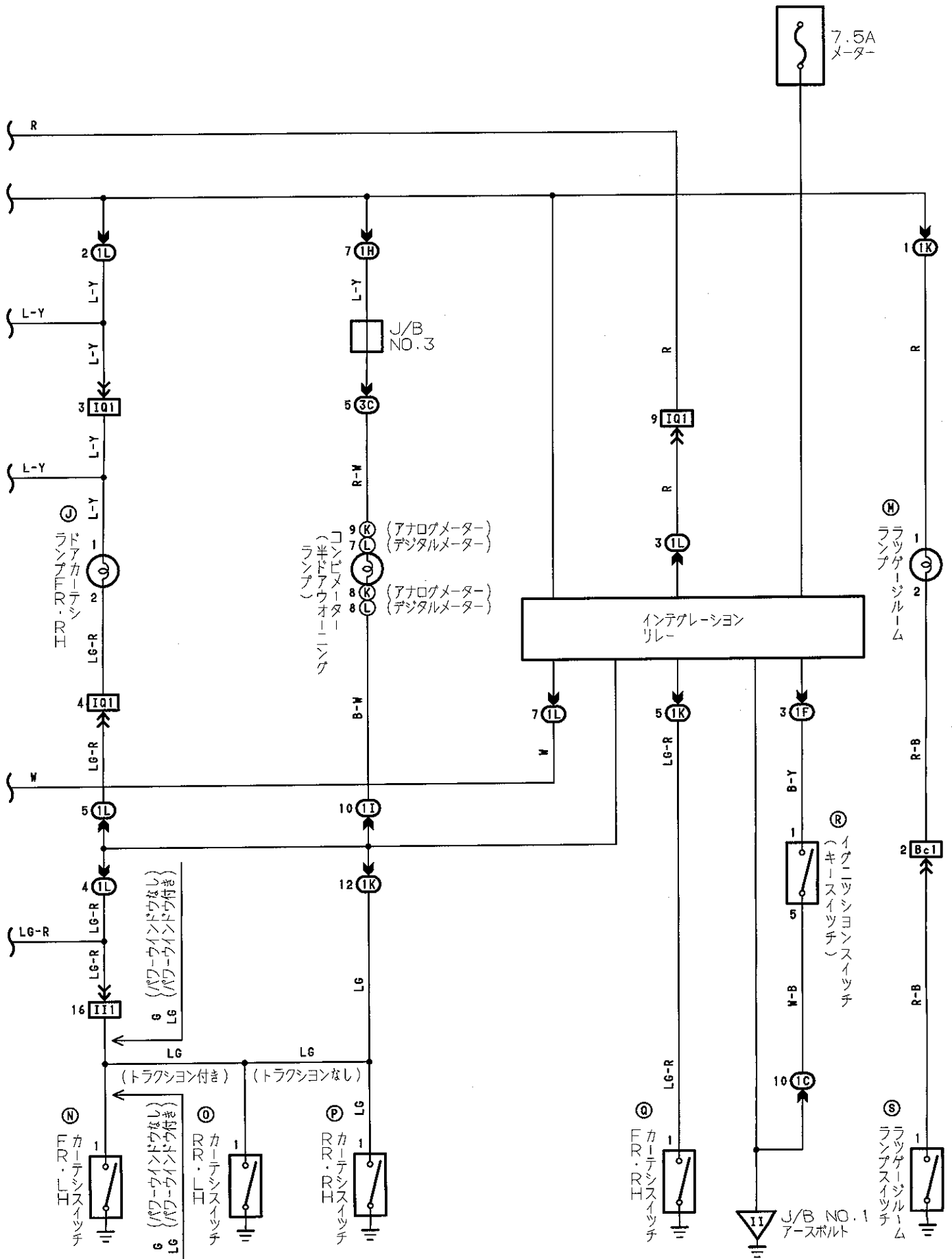
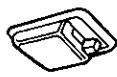

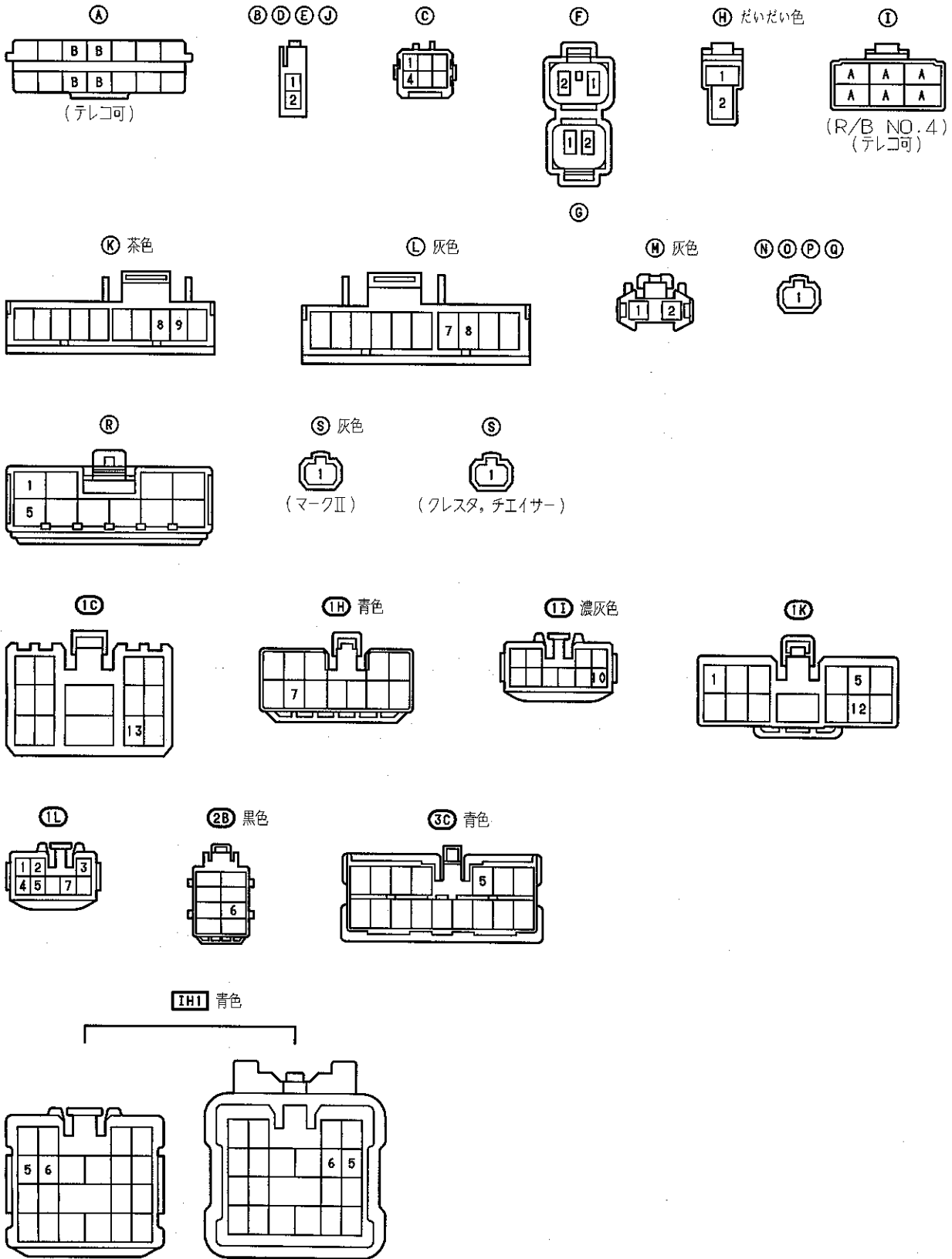

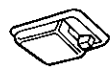

III

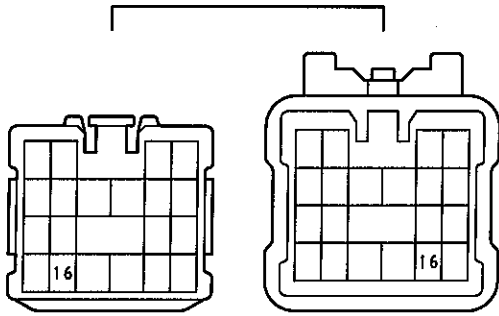

IP1 だいだい色

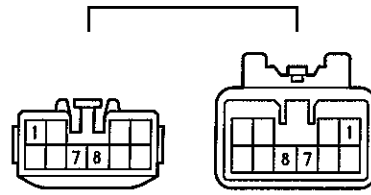

IQ1 青色

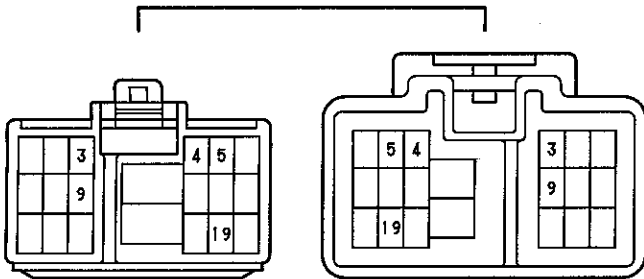

Bc1 黒色

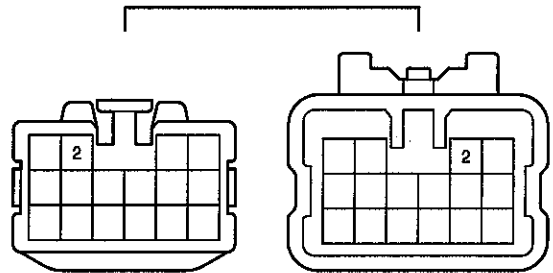

□ セダン LOグレード, タクシー
 △ 除くセダン LOグレード, タクシー

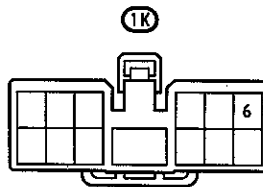
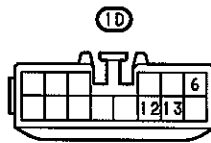
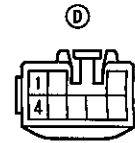
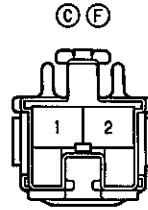
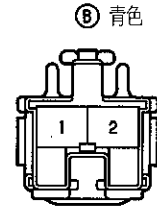
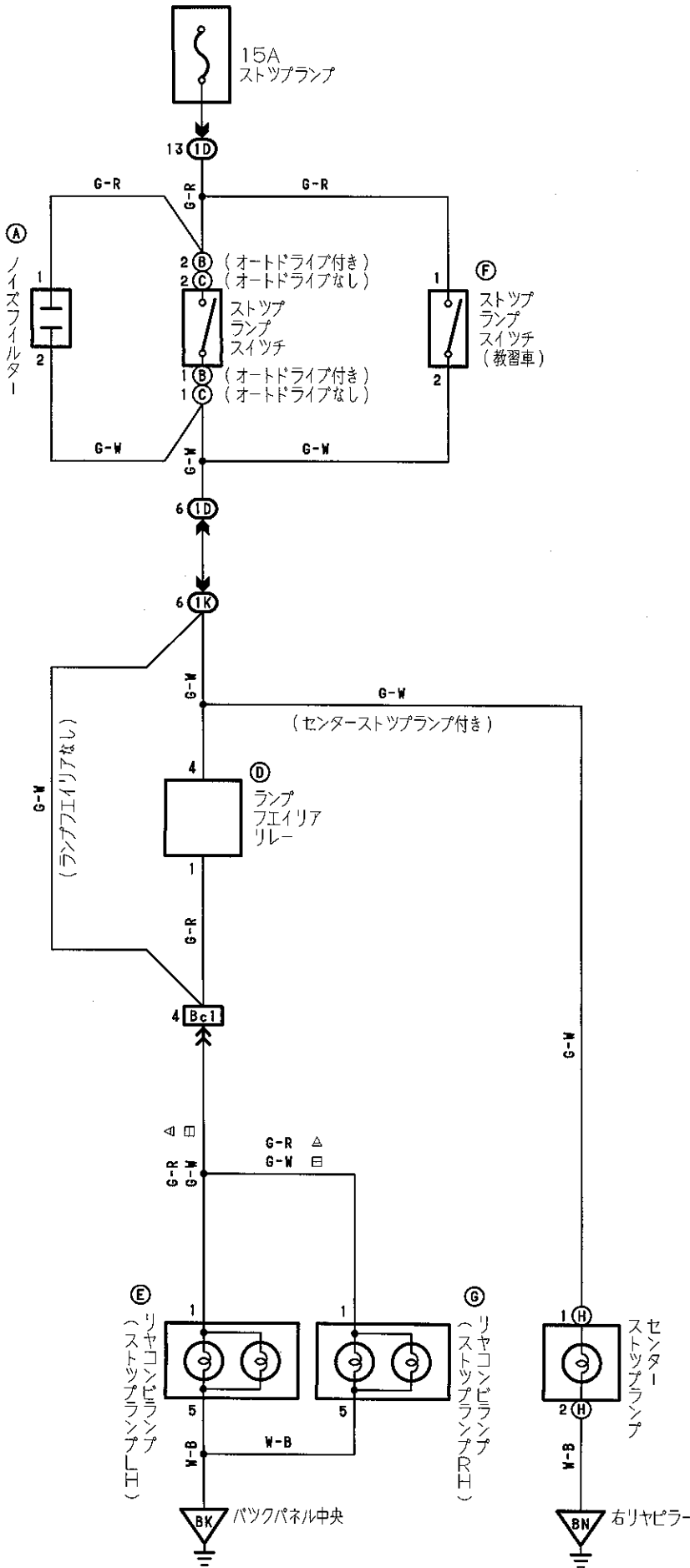

Bc1 黒色

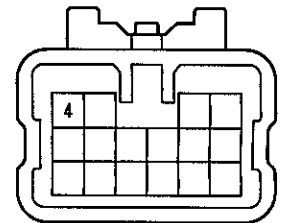
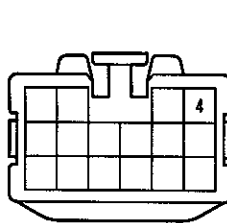

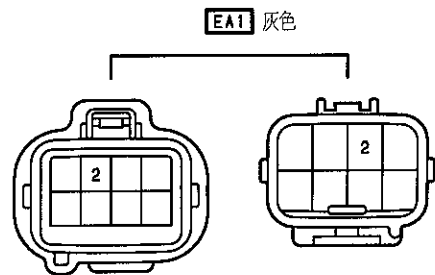
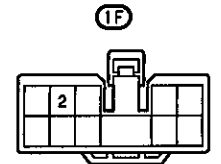
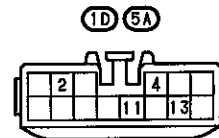
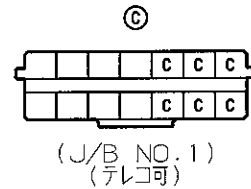
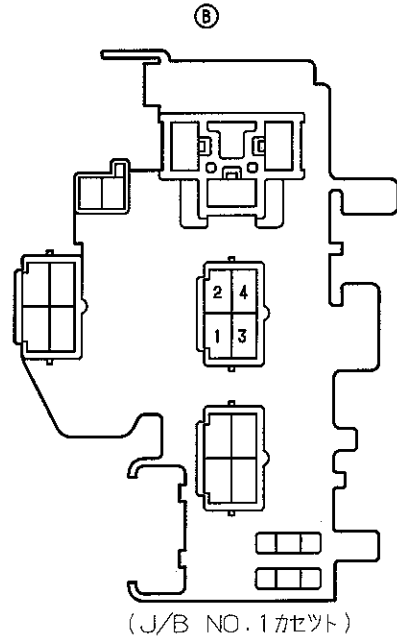
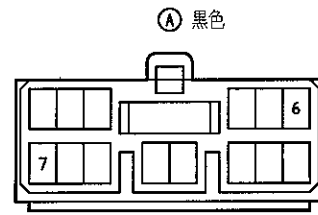
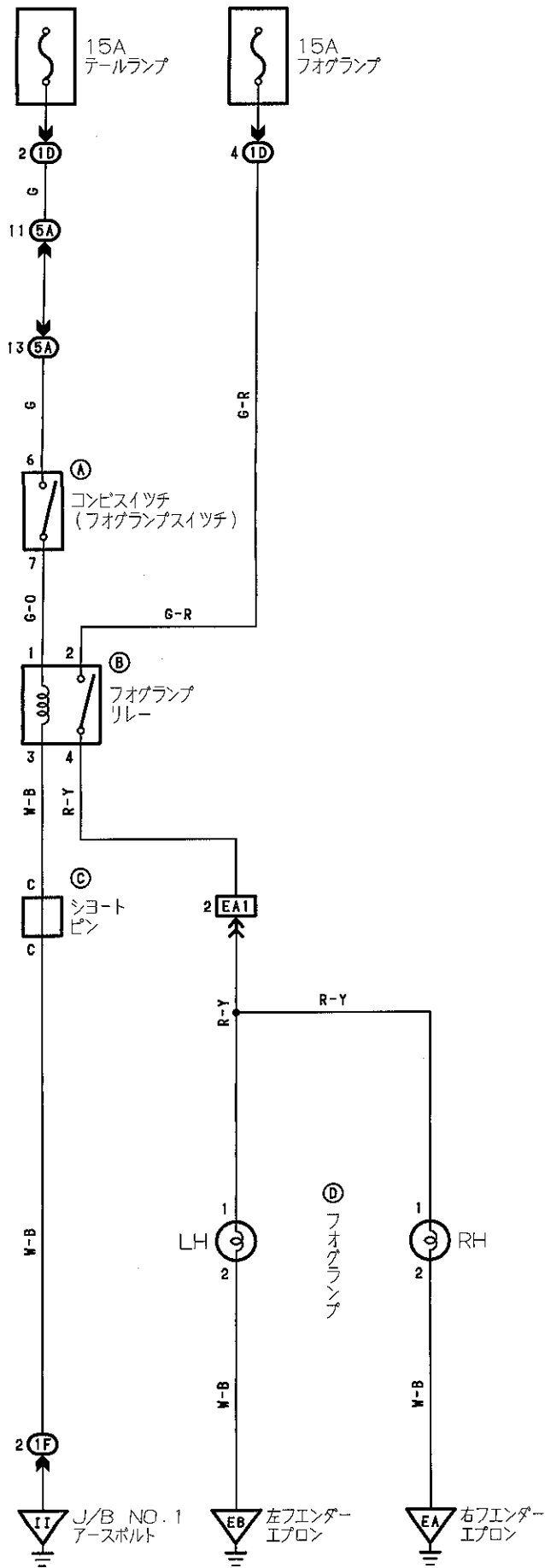
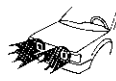

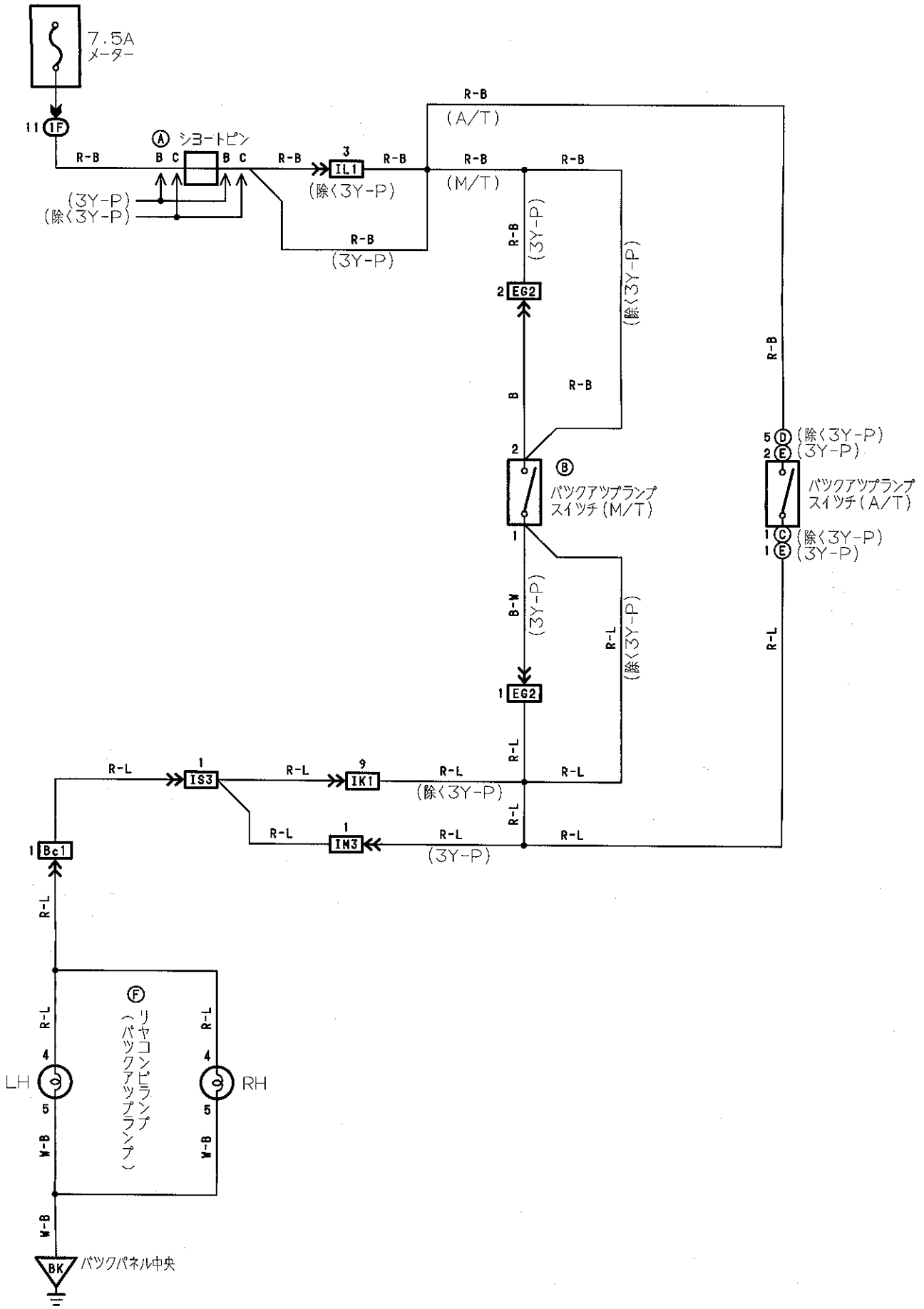

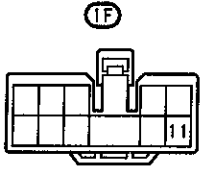
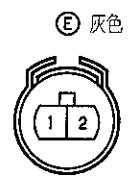
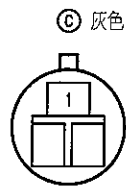
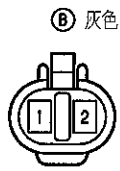
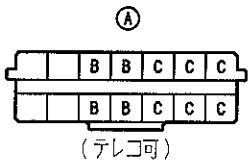

EG2 灰色

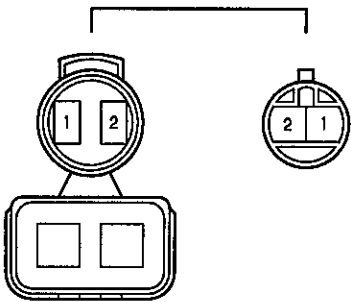

IK1

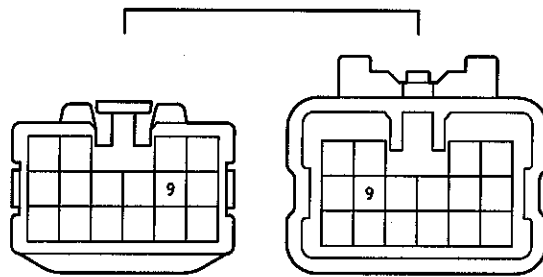

IL1 濃灰色

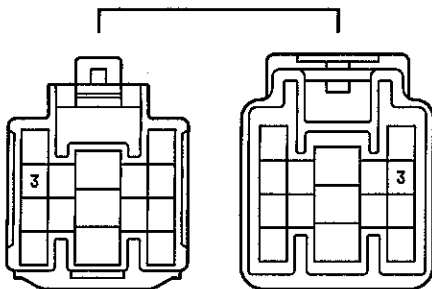

IN3

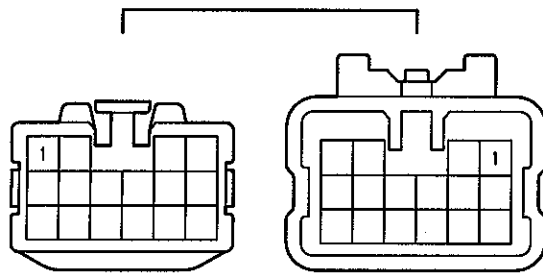

IS3 だいたい色

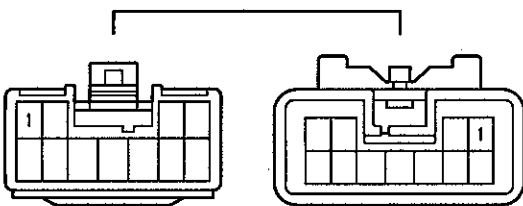

Bc1 黒色

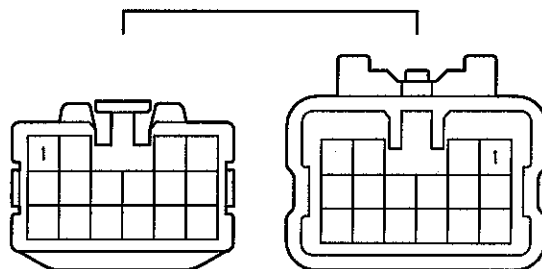

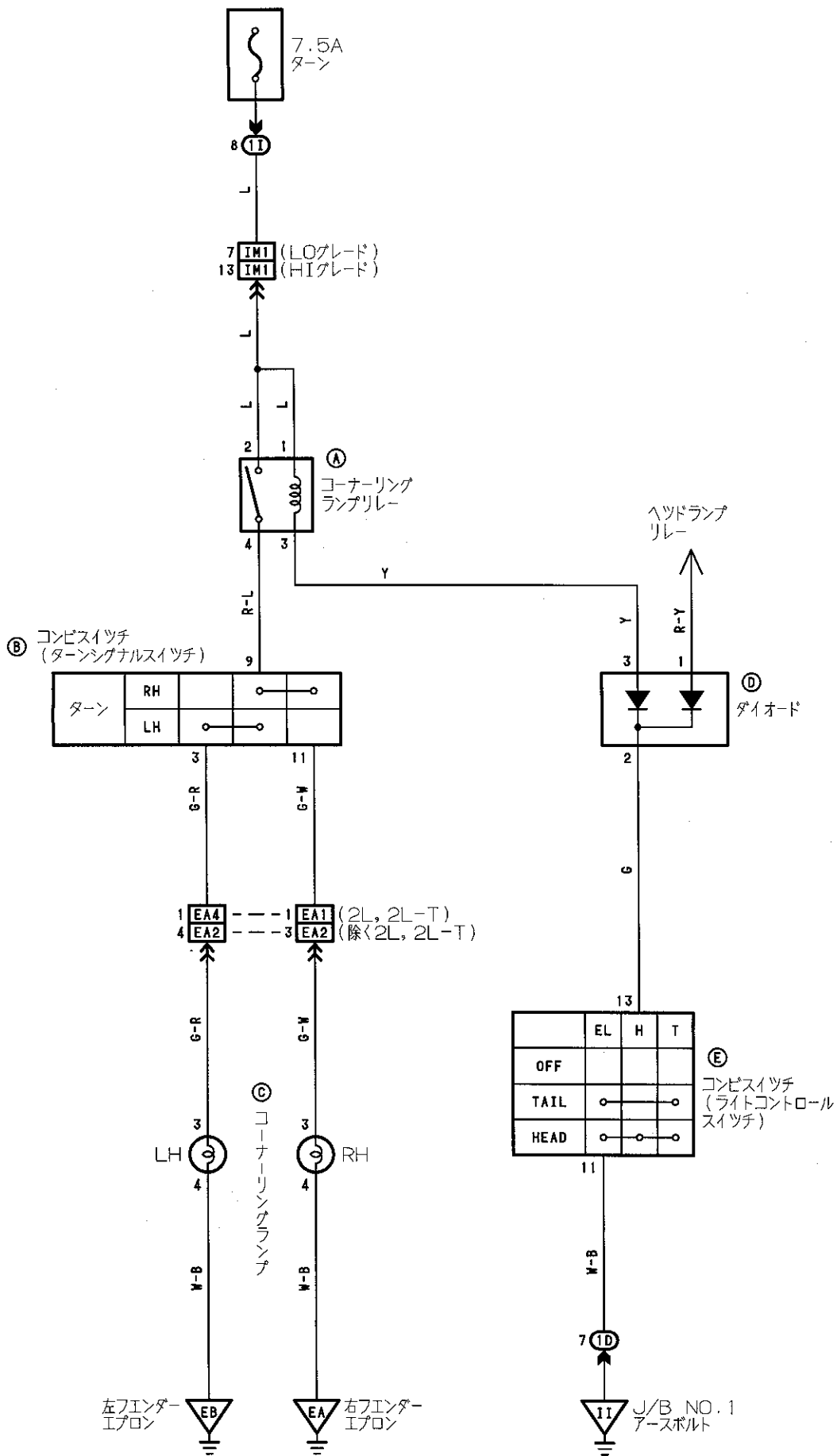



Ⓐ

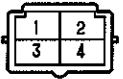

(R/B NO.5)

Ⓑ 黒色

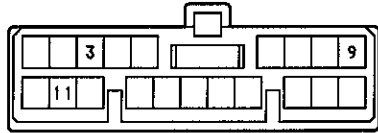

Ⓒ 灰色

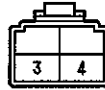

Ⓓ



(R/B NO.1)

Ⓔ 黒色

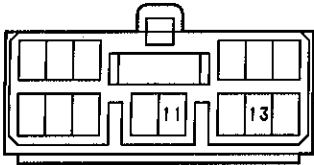

Ⓘ

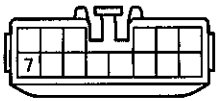

⓫ 濃灰色

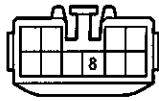

EA1 灰色

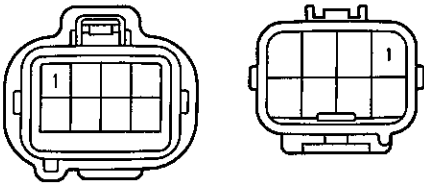

EA2 灰色

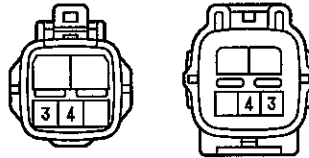

EA4 灰色

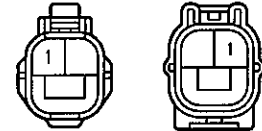

INI

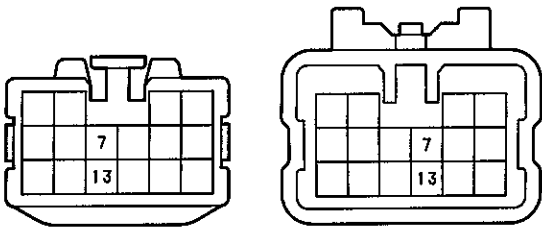



リヤライトウオーニング

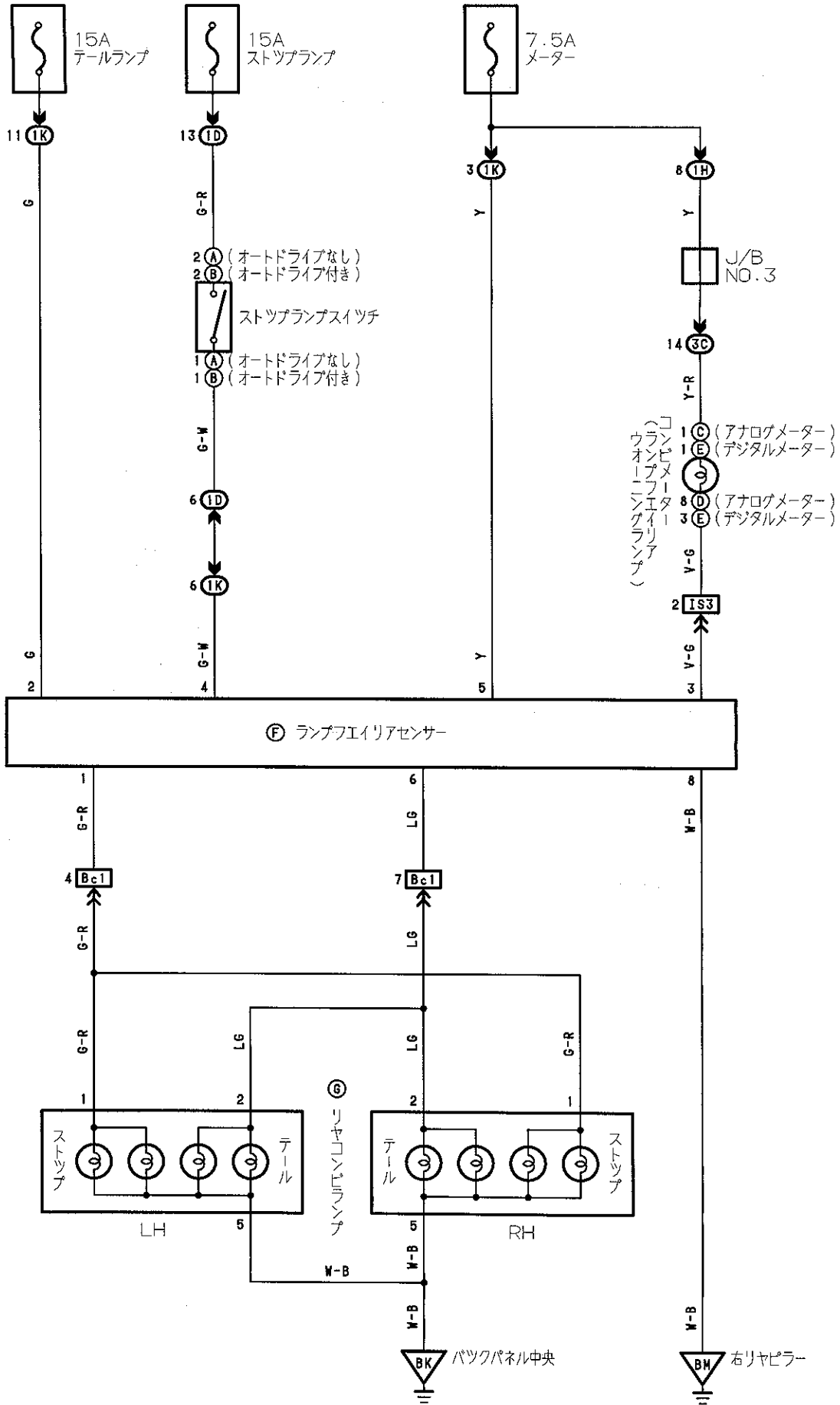

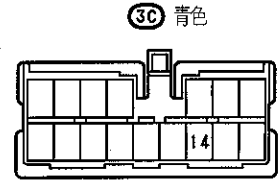
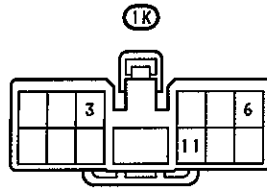
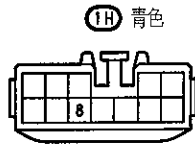
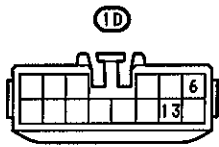
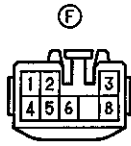
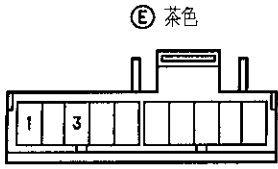
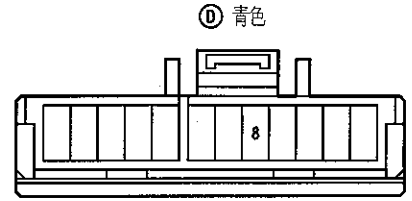
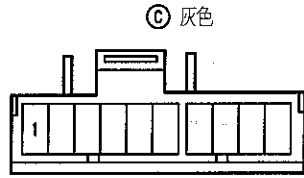
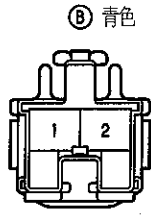
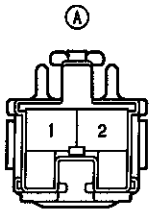

IS3 だいだい色

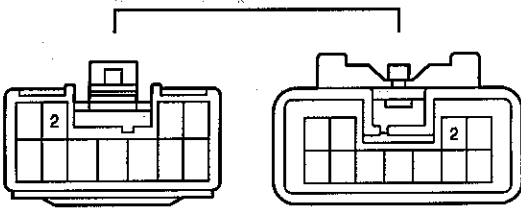

Bc1 黒色

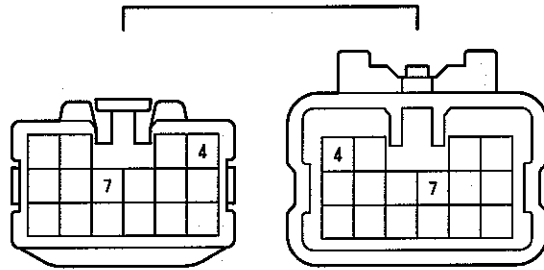

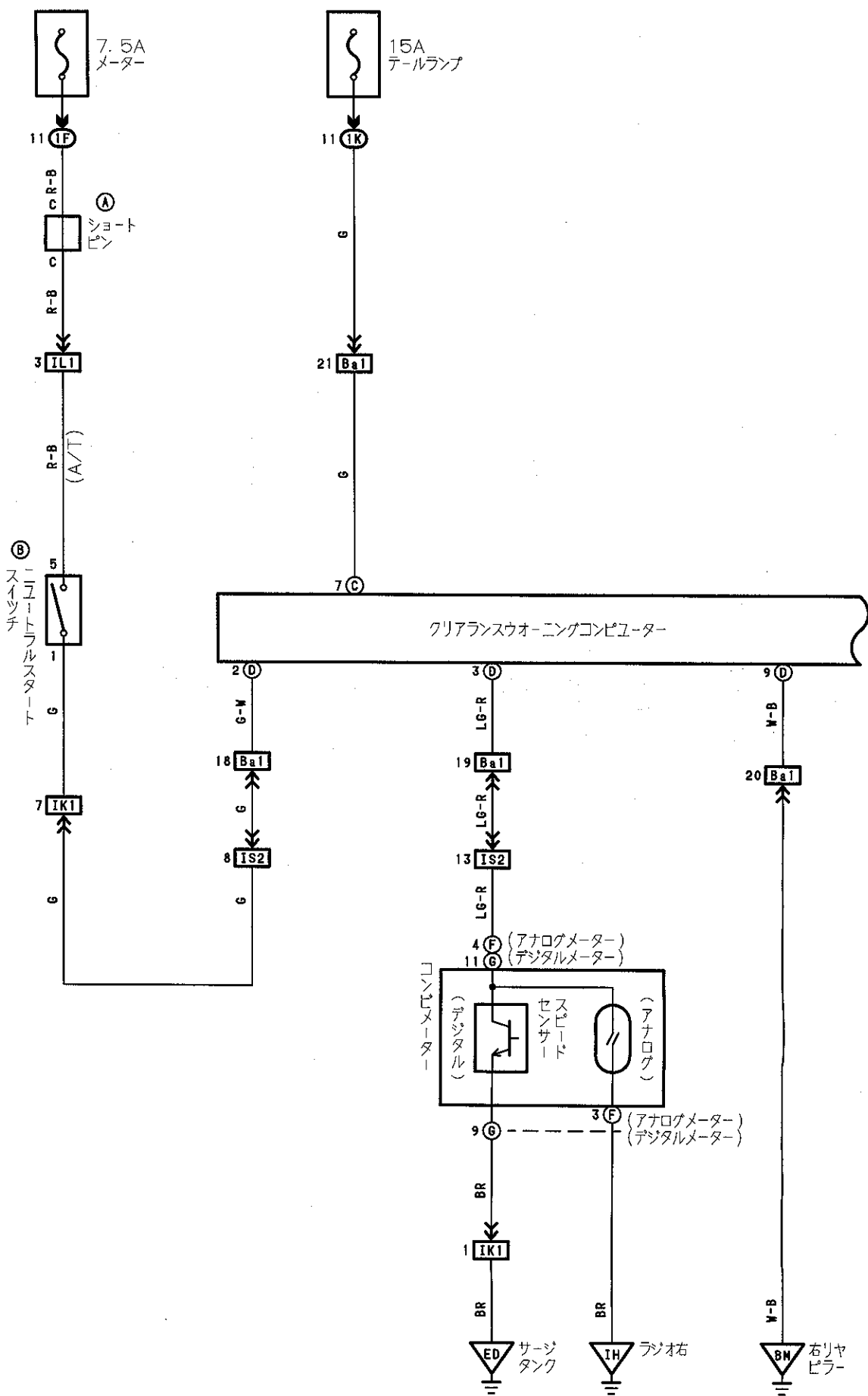

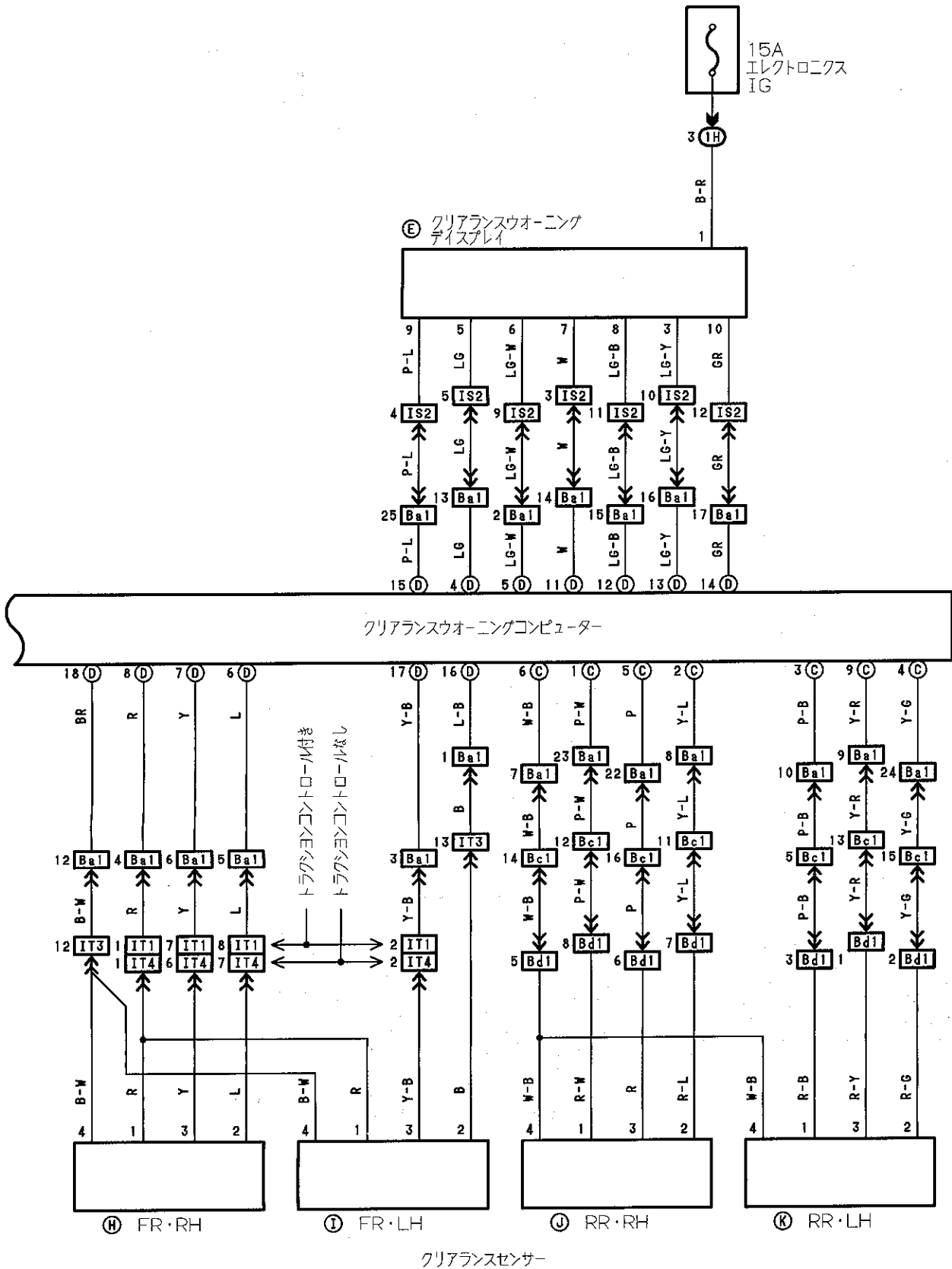

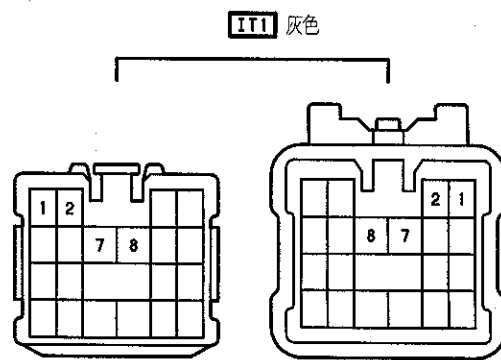
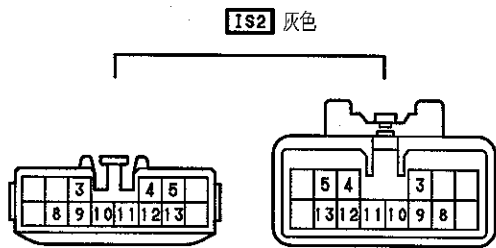
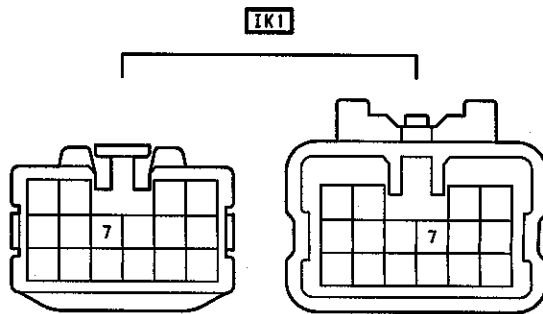
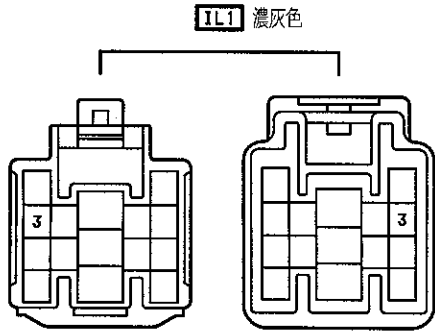
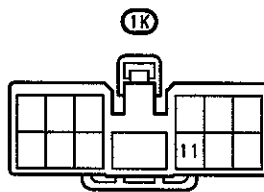
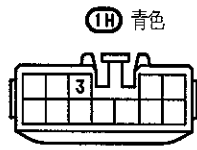
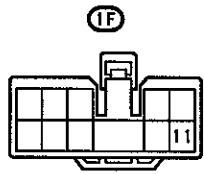
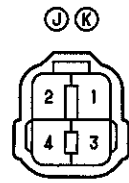
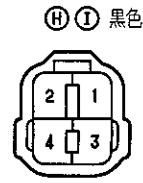
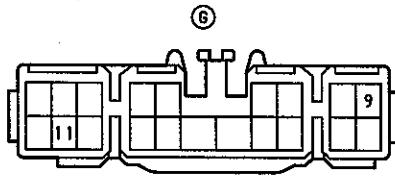
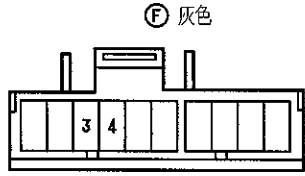
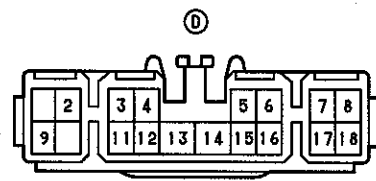
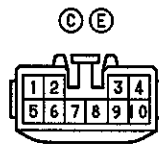
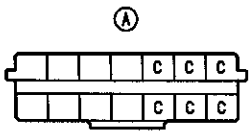

IT3

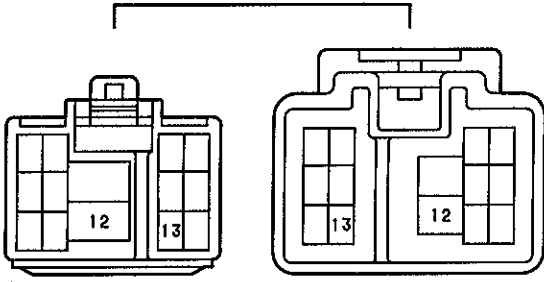

IT4 灰色

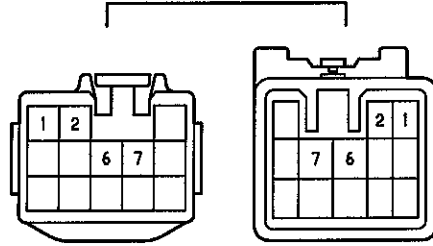

Ba1 濃灰色

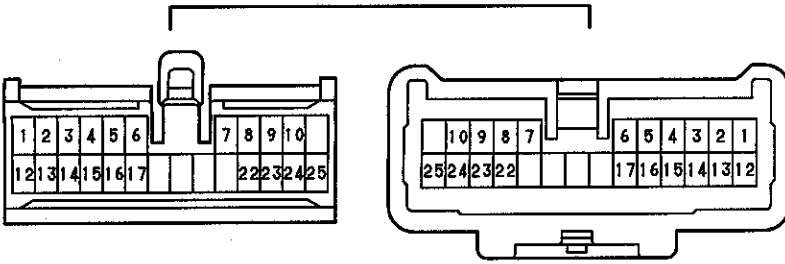

Bc1

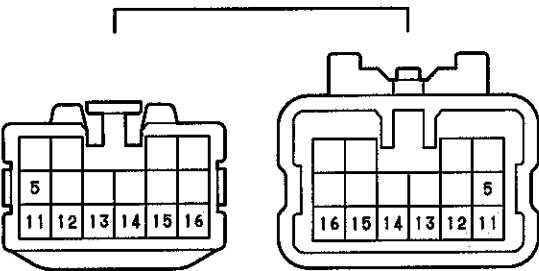

Bd1

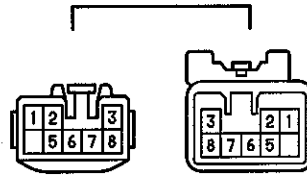

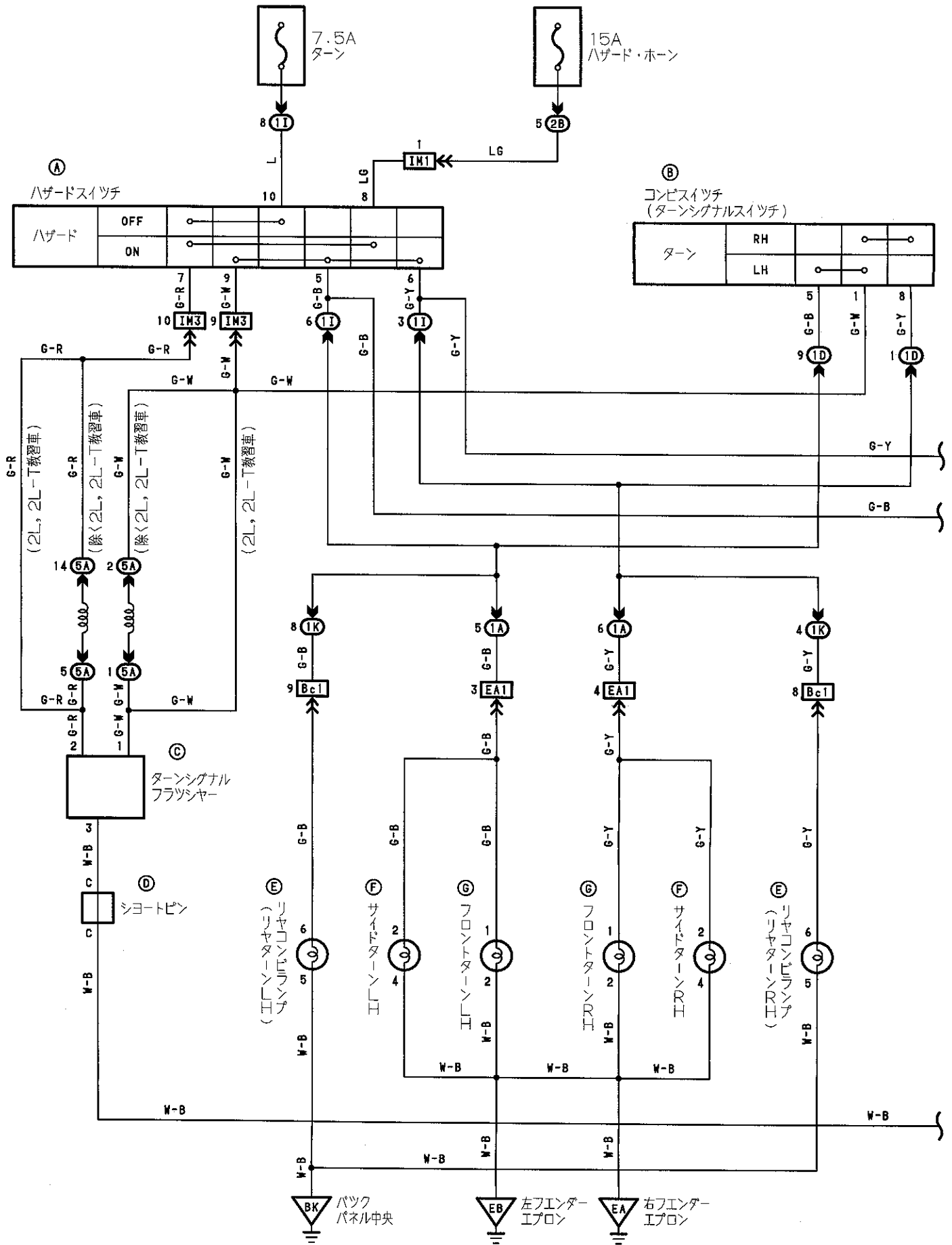

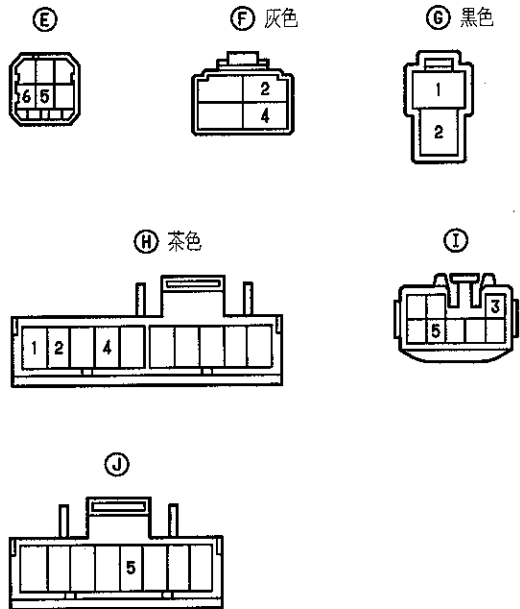
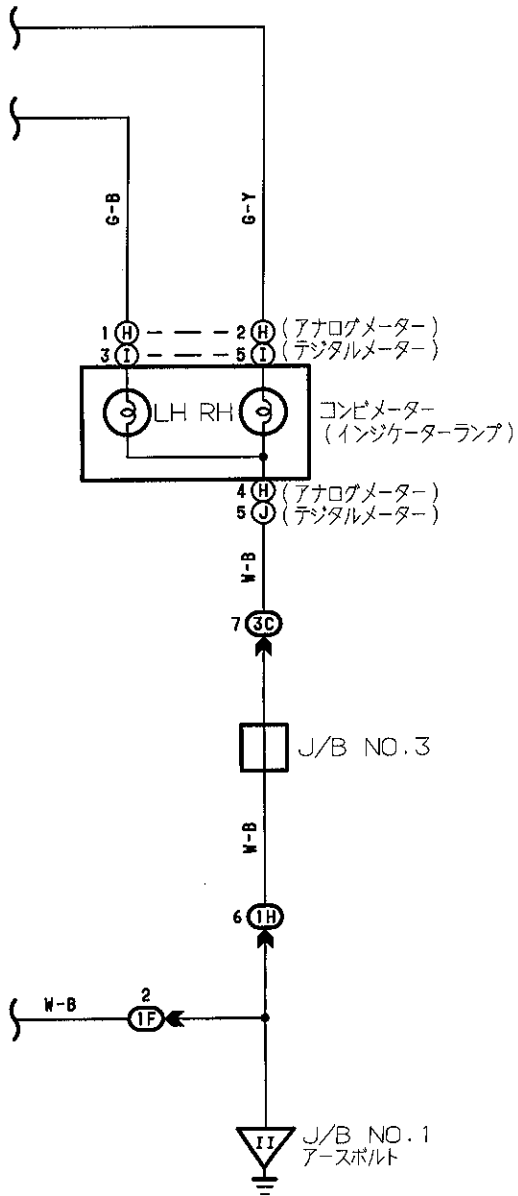
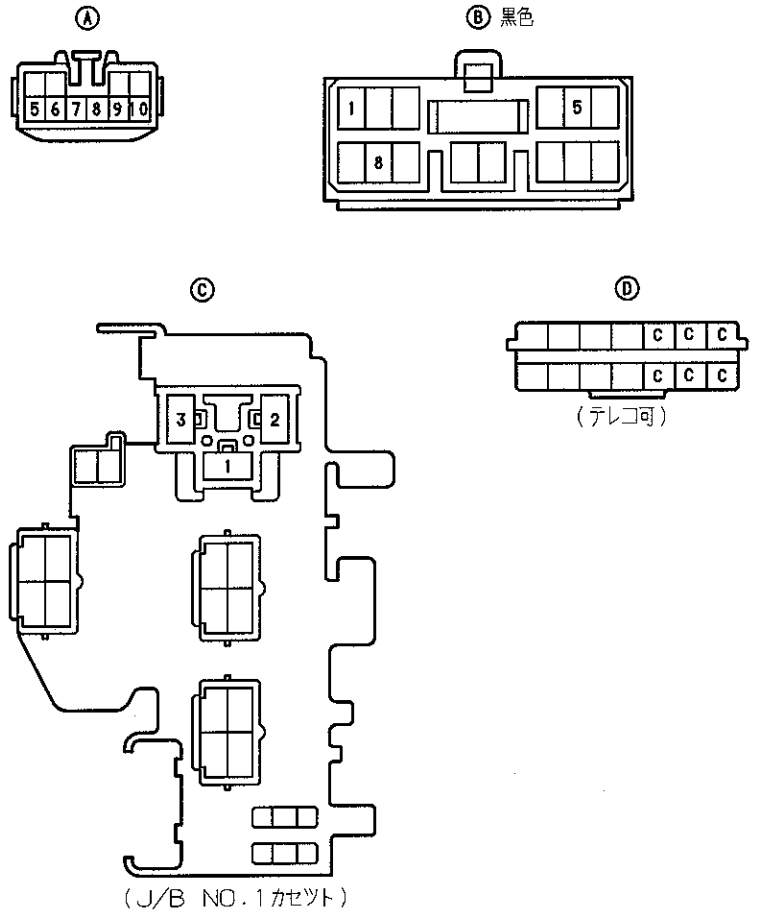



1A 黒色

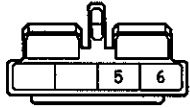

1D

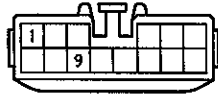

1F

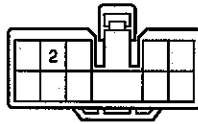

1H 青色



1J 濃灰色



1K

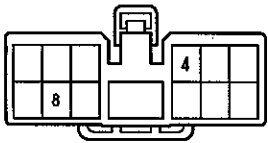

2B 黒色

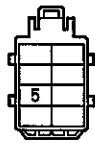

3C 青色

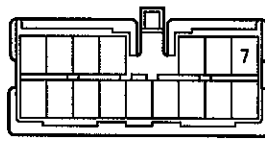

5A

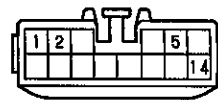

EA1 灰色

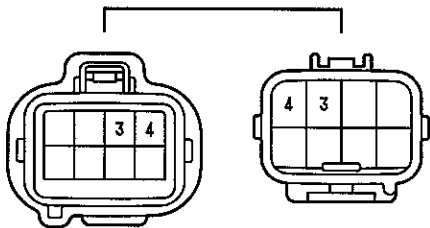

IM1 IM3

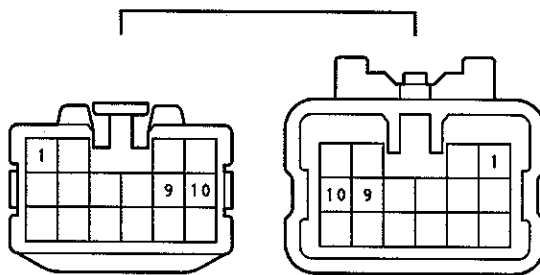

Bc1 黒色

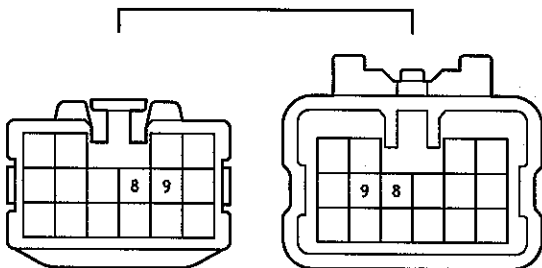

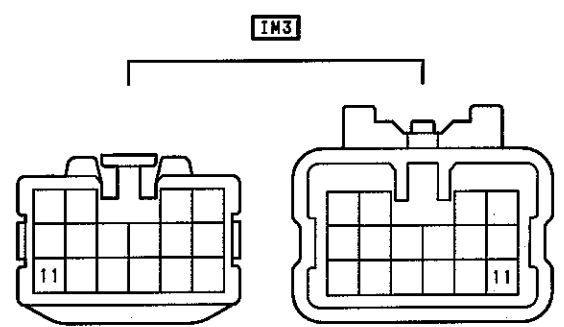
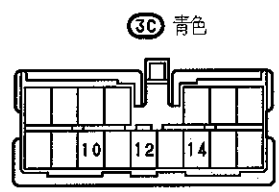
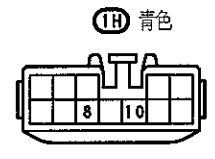
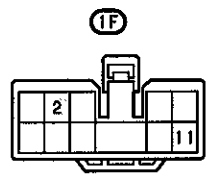
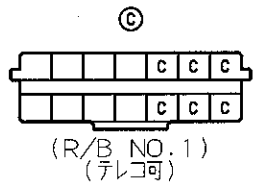
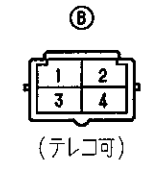
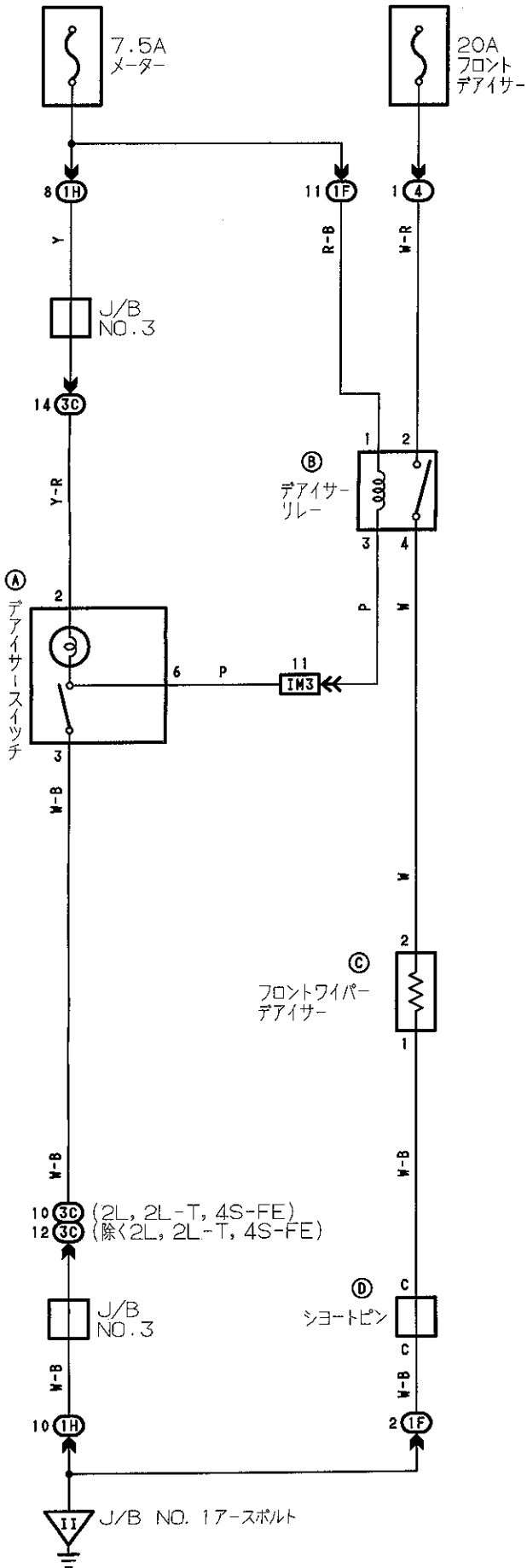
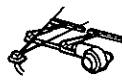

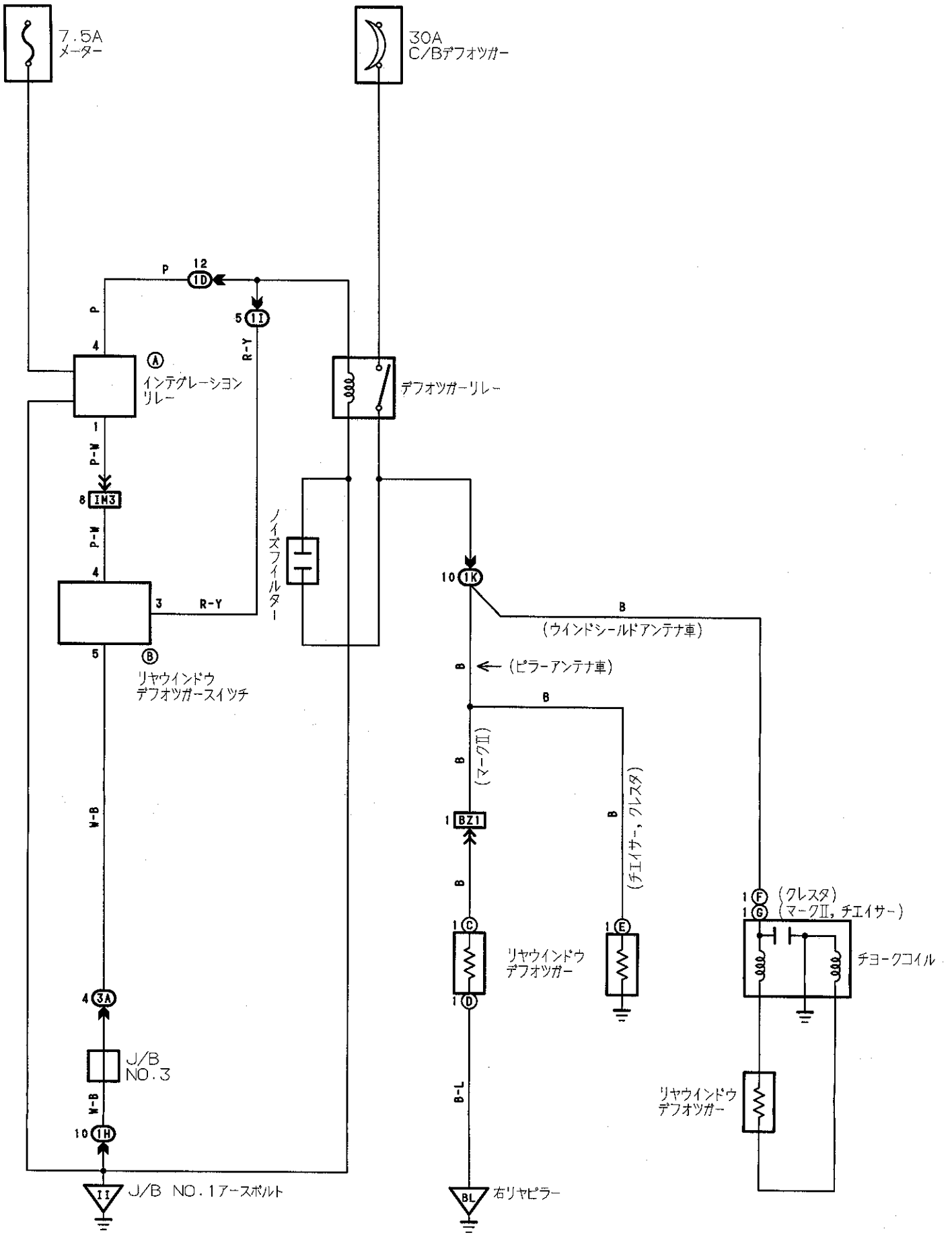

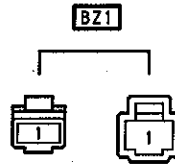
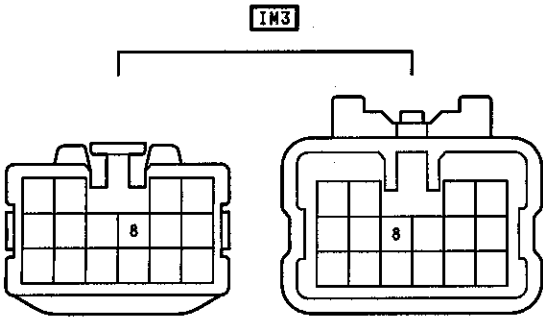
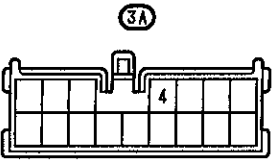
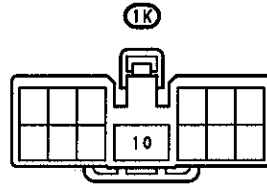
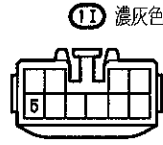
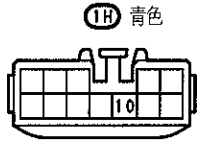
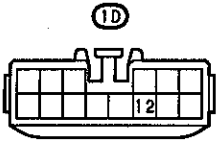
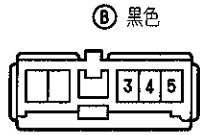
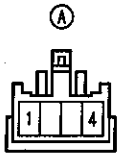
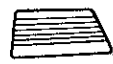

△ (マークII, チェイサー)
 □ (クレスタ)

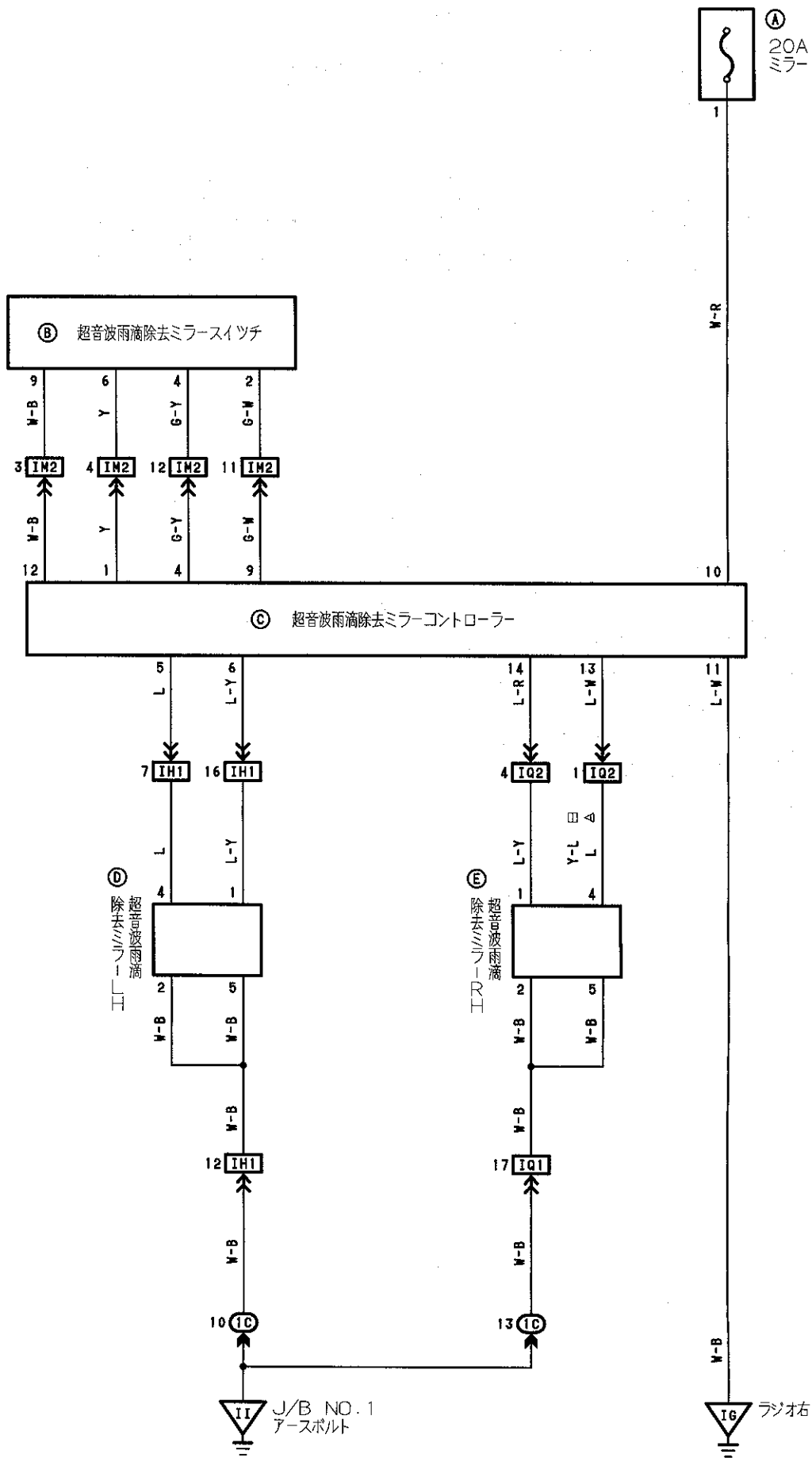

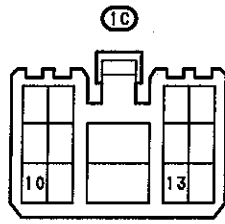
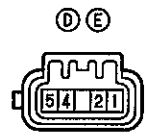
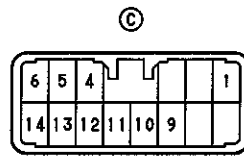
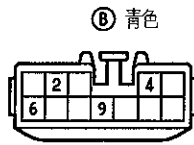
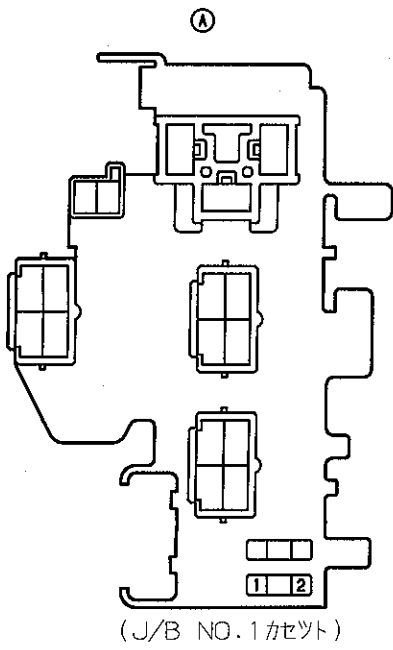

⑦ 青色

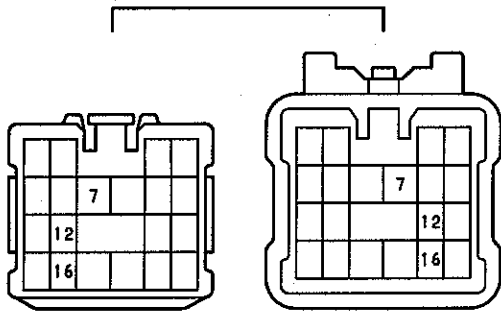

⑧

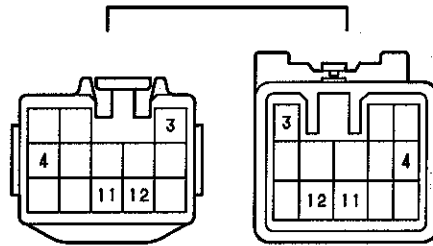

⑨ 青色

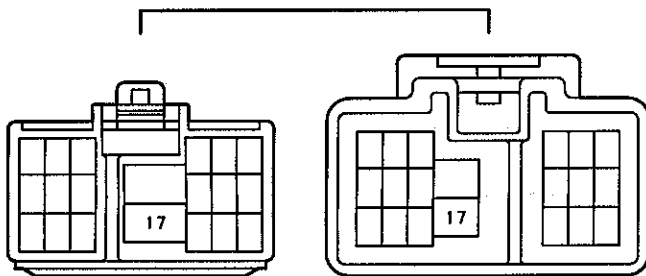

⑩ 青色

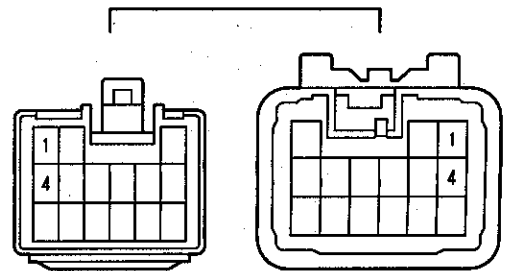

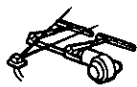

Ⓐ 灰色



Ⓑ 黒色

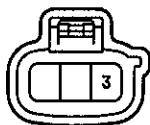

Ⓒ 黒色

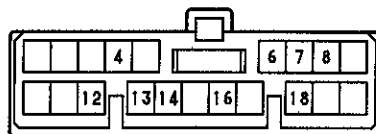

Ⓓ 黒色



Ⓔ

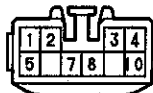

ⓓ ⓔⒶ

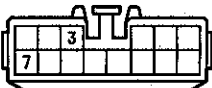

ⓓⒻ

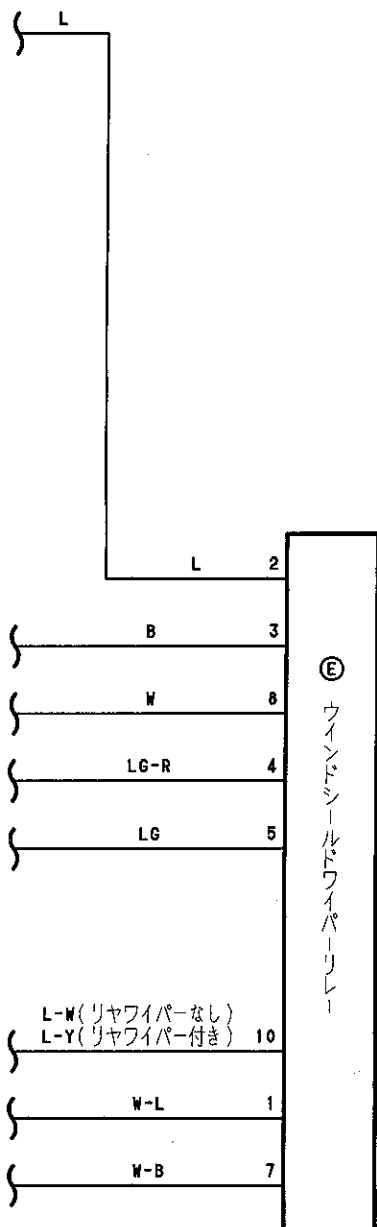
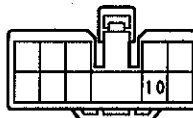

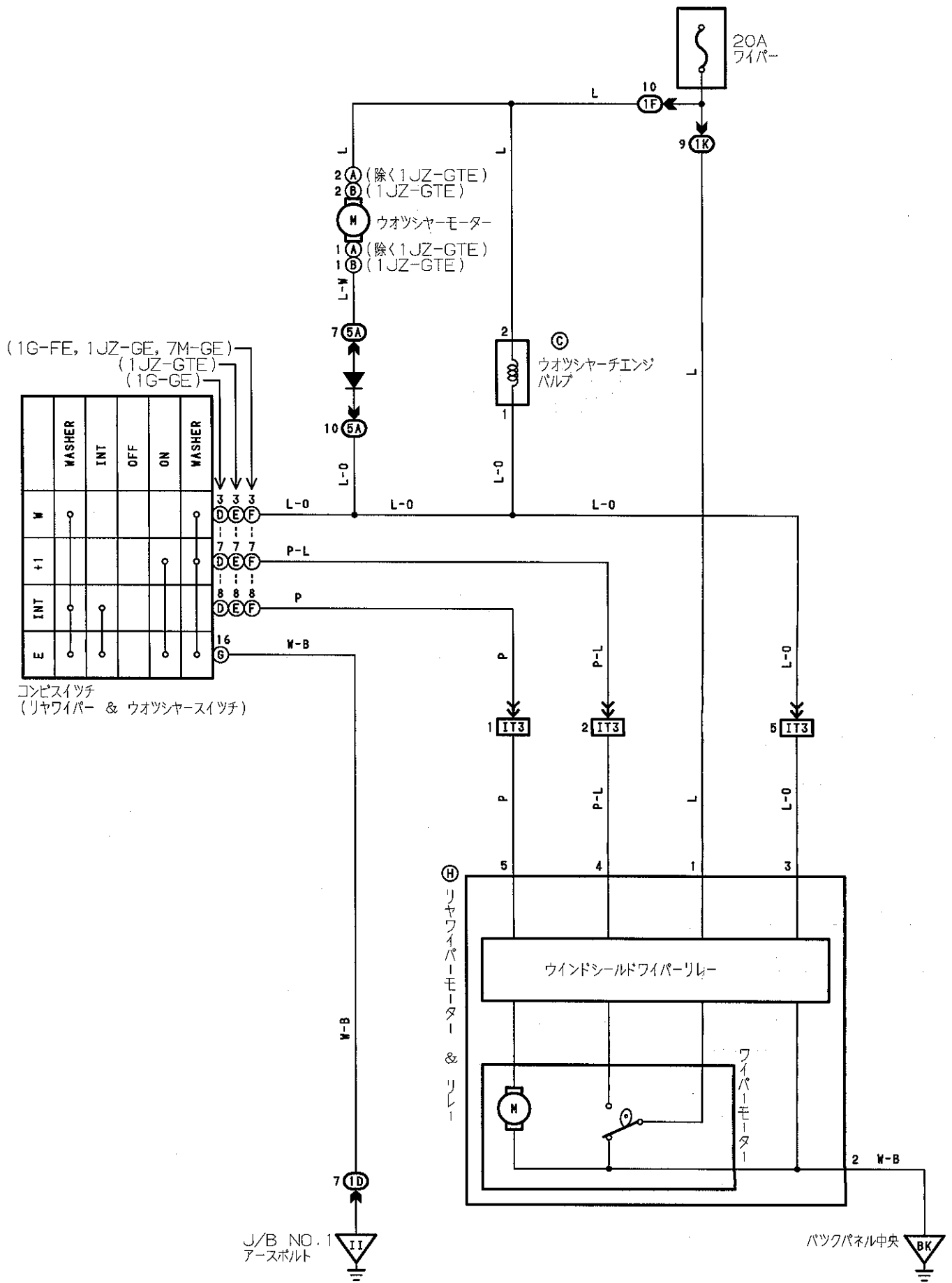

Ⓐ 青色

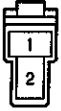

Ⓑ 黒色

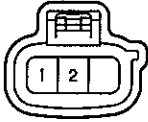

Ⓒ 灰色



(1G-FE) Ⓓ 濃灰色又は無色



(1JZ-GTE) Ⓔ



(1G-FE, 1JZ-GE, 7M-GE) Ⓕ 濃灰色



Ⓖ 黒色

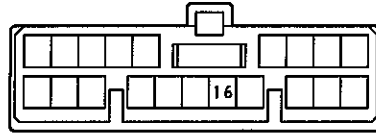

Ⓖ

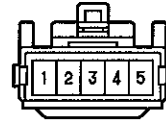

ⓓ ⓔ

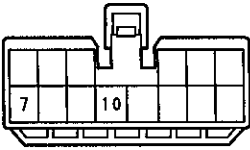

ⓓ

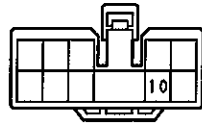

ⓓ

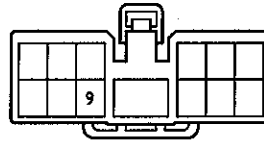

ⓓ

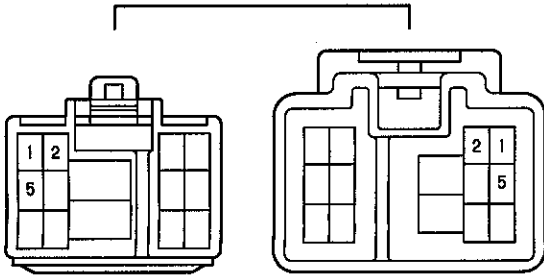

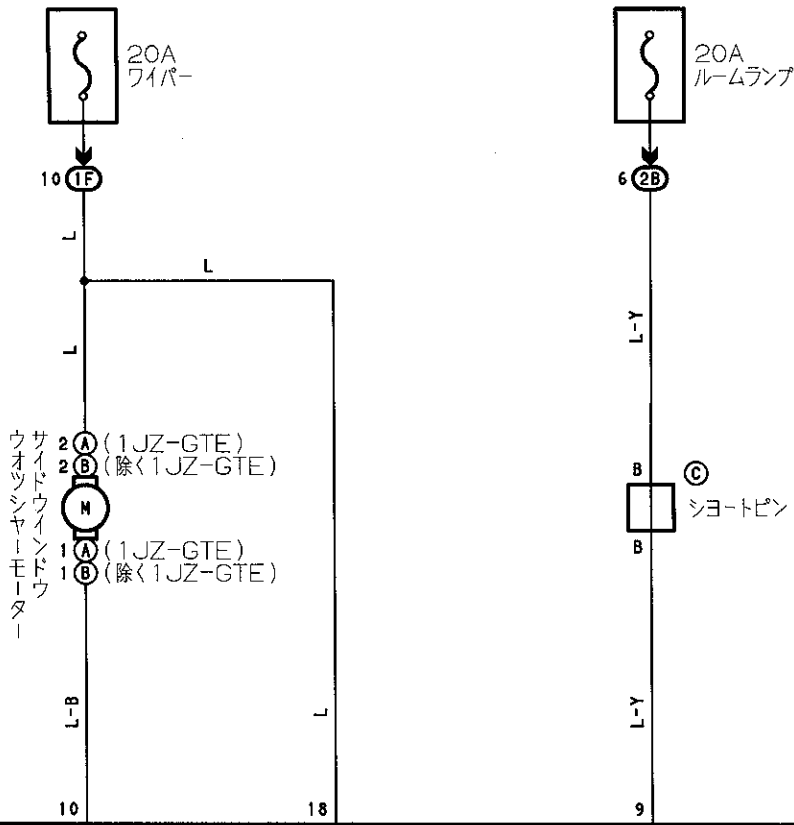

④ サイドウィンドウワイパーリレー

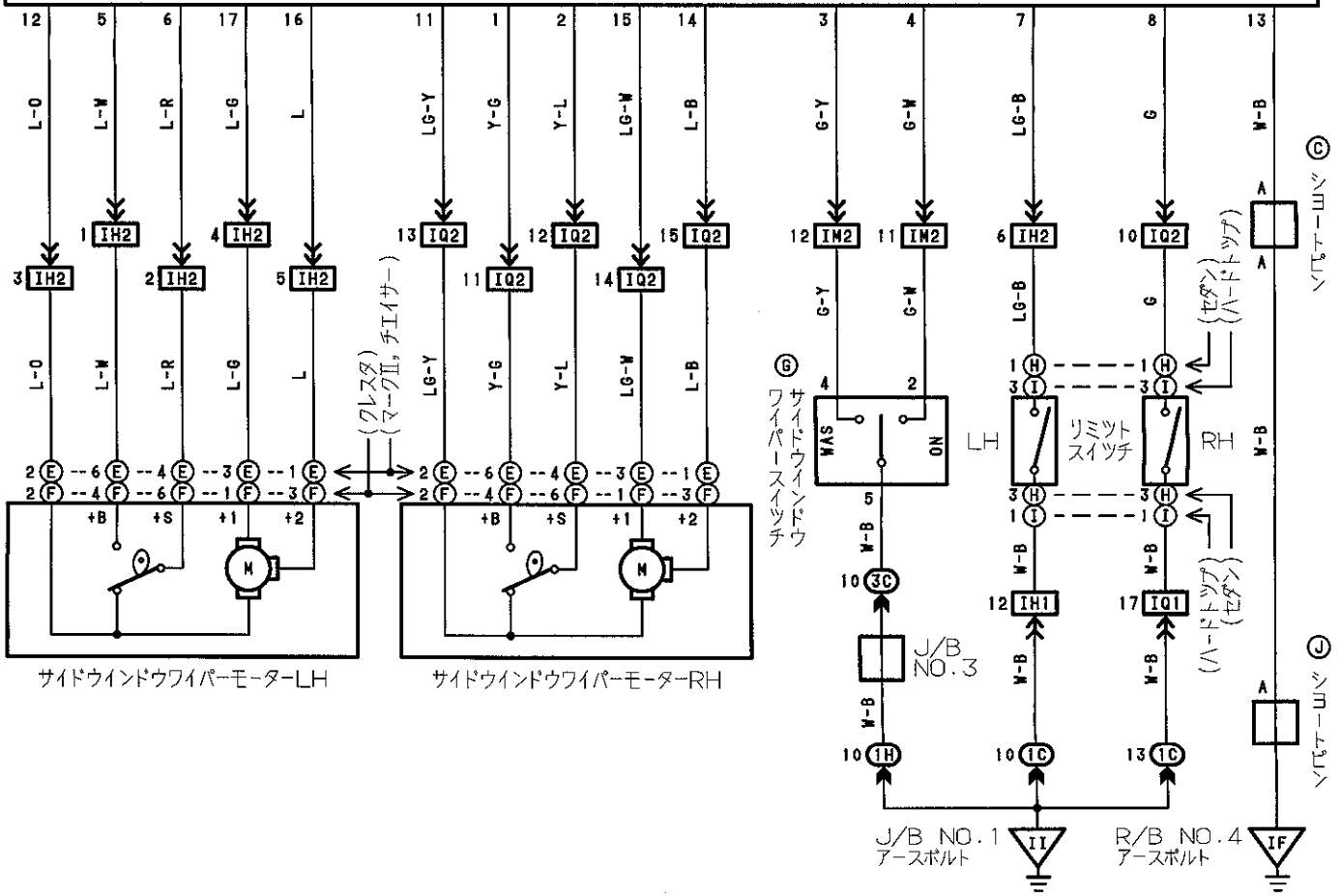



Ⓐ 黒色



Ⓑ 黒色



Ⓒ

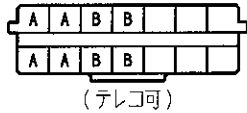

Ⓓ

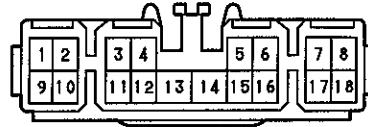

Ⓔ

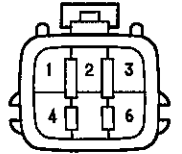

Ⓕ

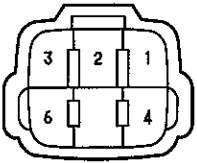

Ⓖ 青色

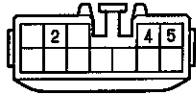

Ⓗ



Ⓘ



Ⓙ

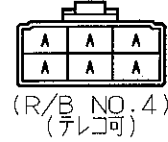

10

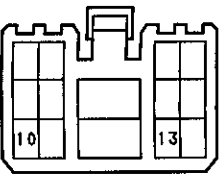

11

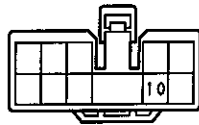

12 青色



20 黒色

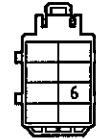

30 青色

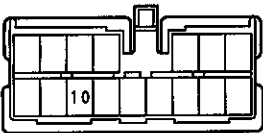

121 青色

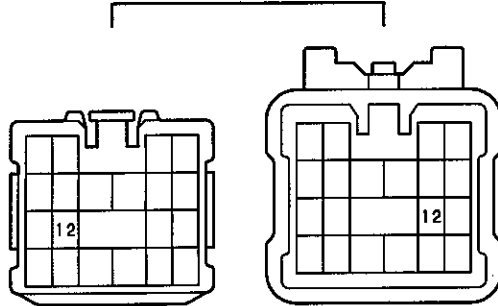

122 青色

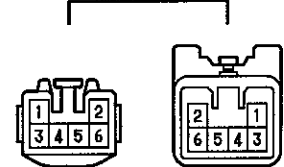

122

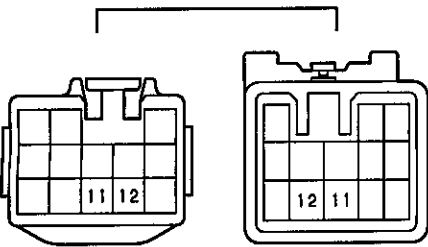

101 青色

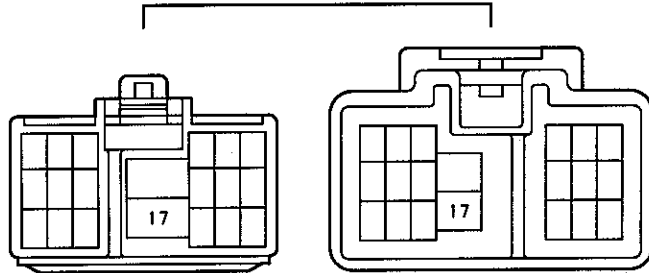

102 青色

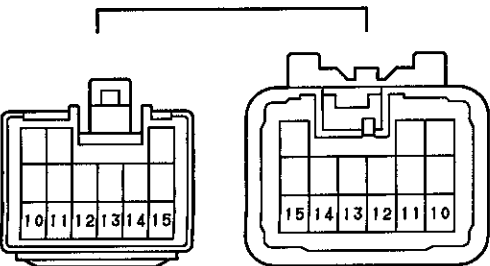



テンションリデューサー (Qグレード以上)

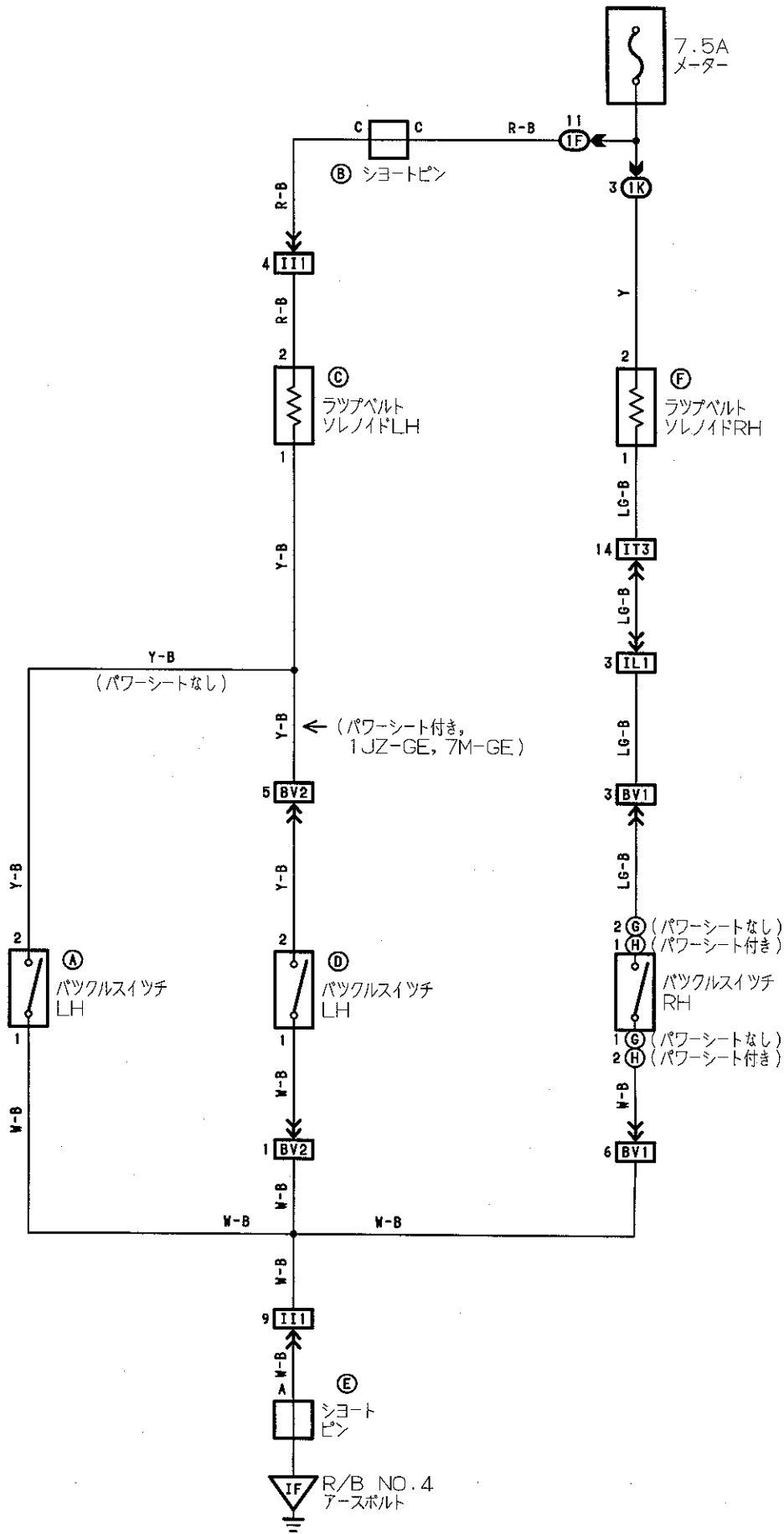



Ⓐ Ⓒ Ⓕ Ⓖ



Ⓑ

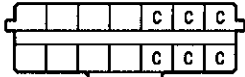

(J/B NO. 1)
(テレコ可)

Ⓓ Ⓗ 黒色



Ⓔ

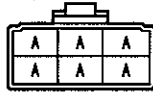

(R/B NO. 4)
(テレコ可)

Ⓘ Ⓕ

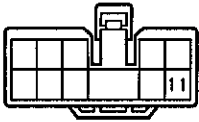

Ⓚ

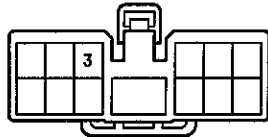

Ⓛ Ⓛ

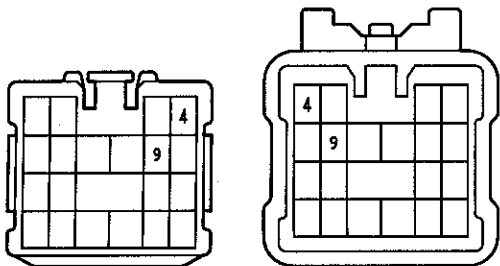

Ⓛ Ⓛ 濃灰色

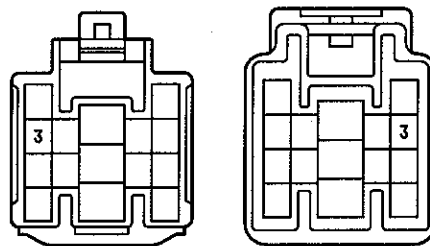

Ⓛ Ⓛ

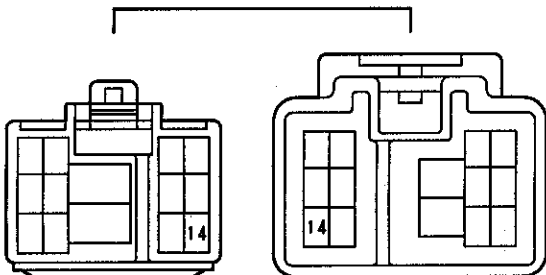

Ⓛ Ⓛ

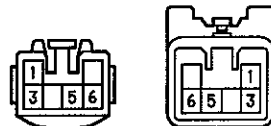



Ⓐ

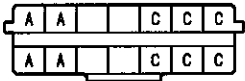

(テレコ可)

Ⓑ

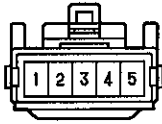

Ⓒ 灰色



Ⓓ

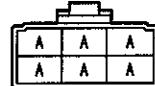

(R/B NO. 4)
(テレコ可)

Ⓔ 灰色

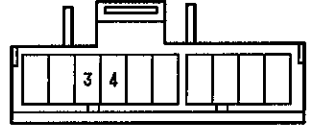

Ⓕ

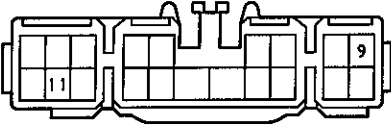

Ⓖ



IK1 IM3

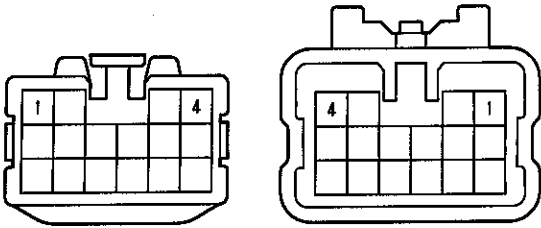



パワーシート (運転席)

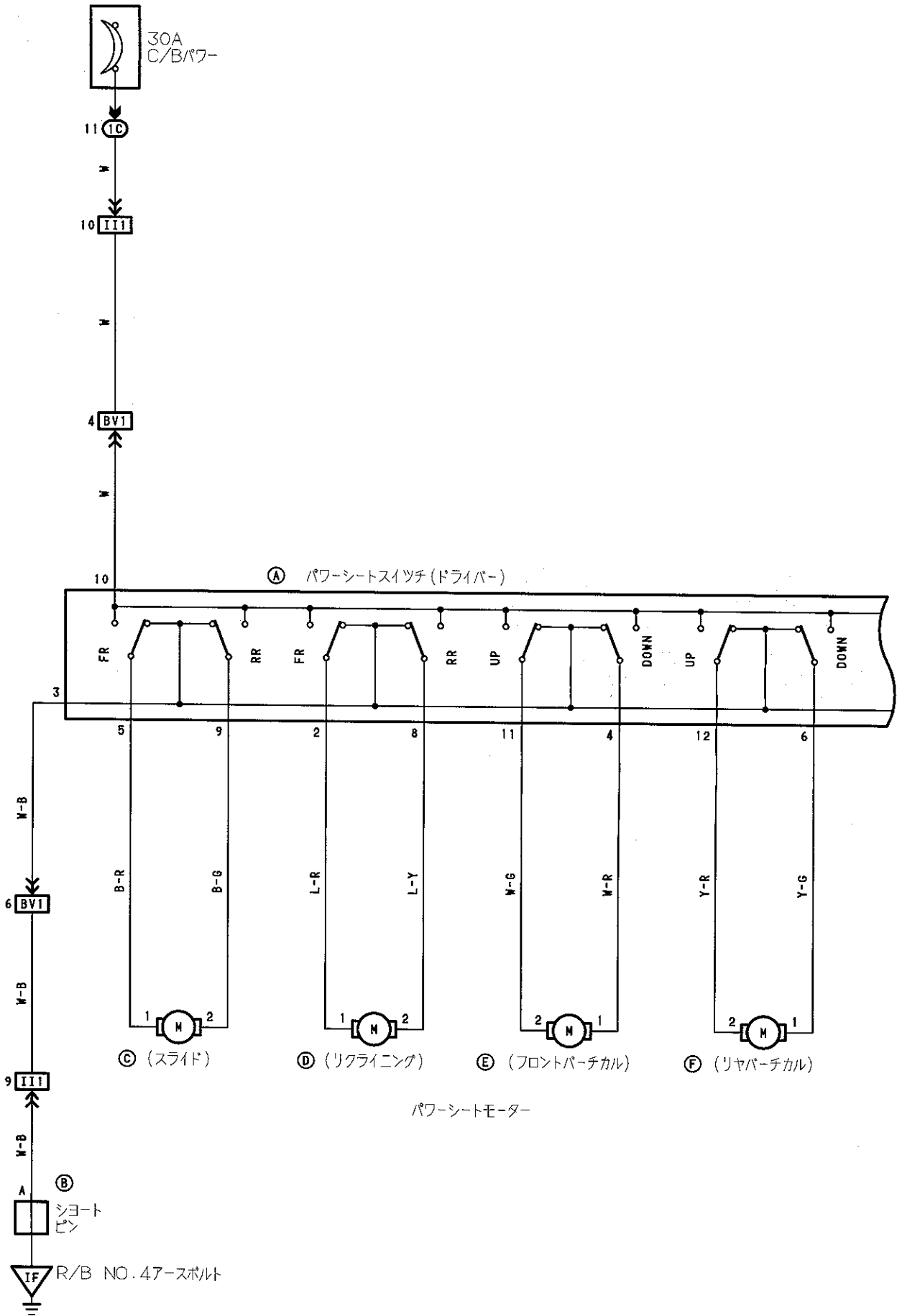

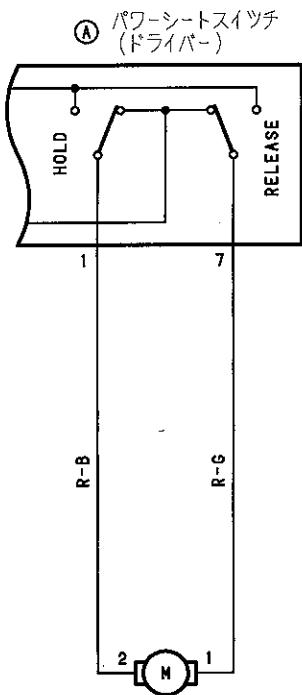
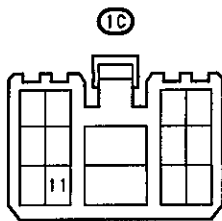
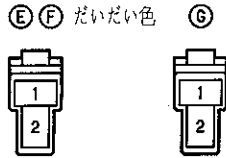
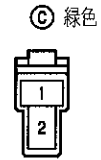
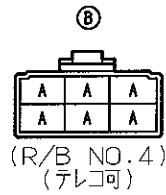
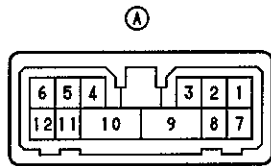

⑬ (ランバーサポート)

パワーシートモーター

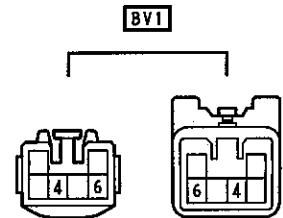
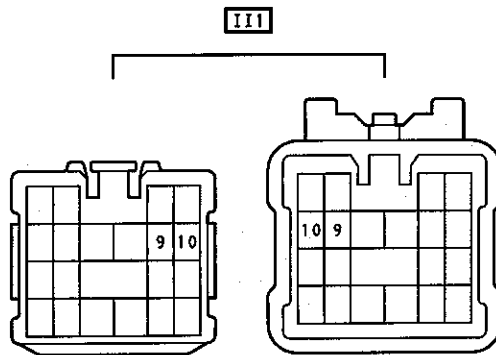

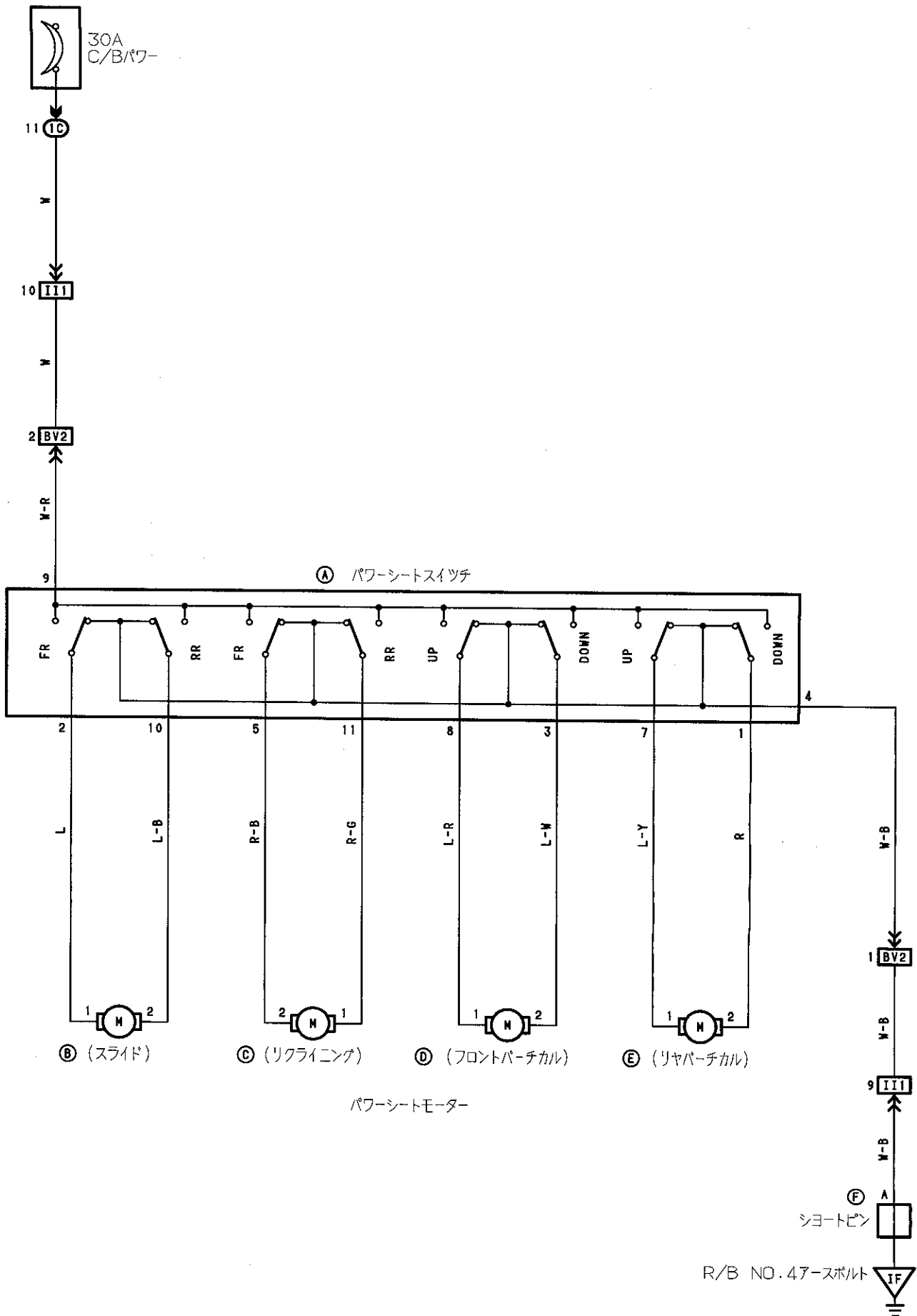



Ⓐ

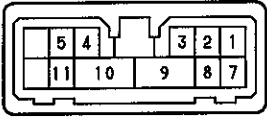

Ⓑ 緑色



Ⓒ



Ⓓ Ⓔ だいたい色

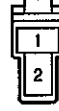

Ⓕ

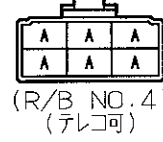

Ⓘ

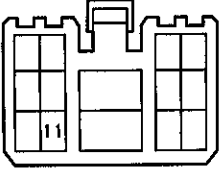

Ⅱ1

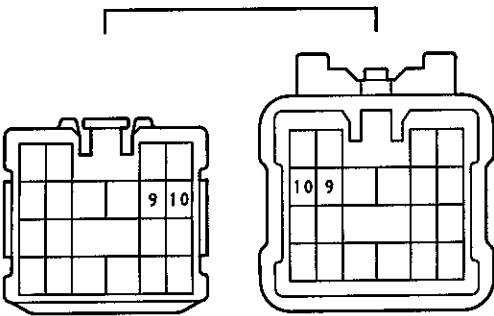

Ⅱ2

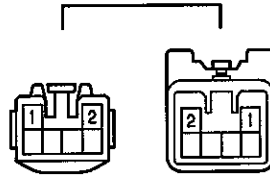

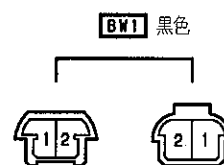
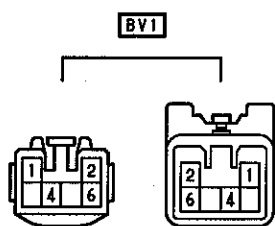
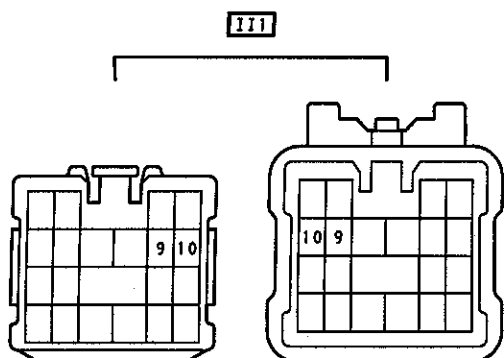
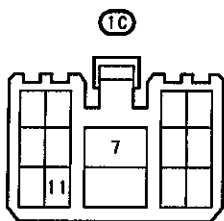
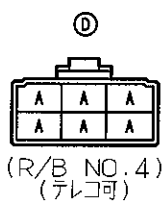



パワーウィンドウ

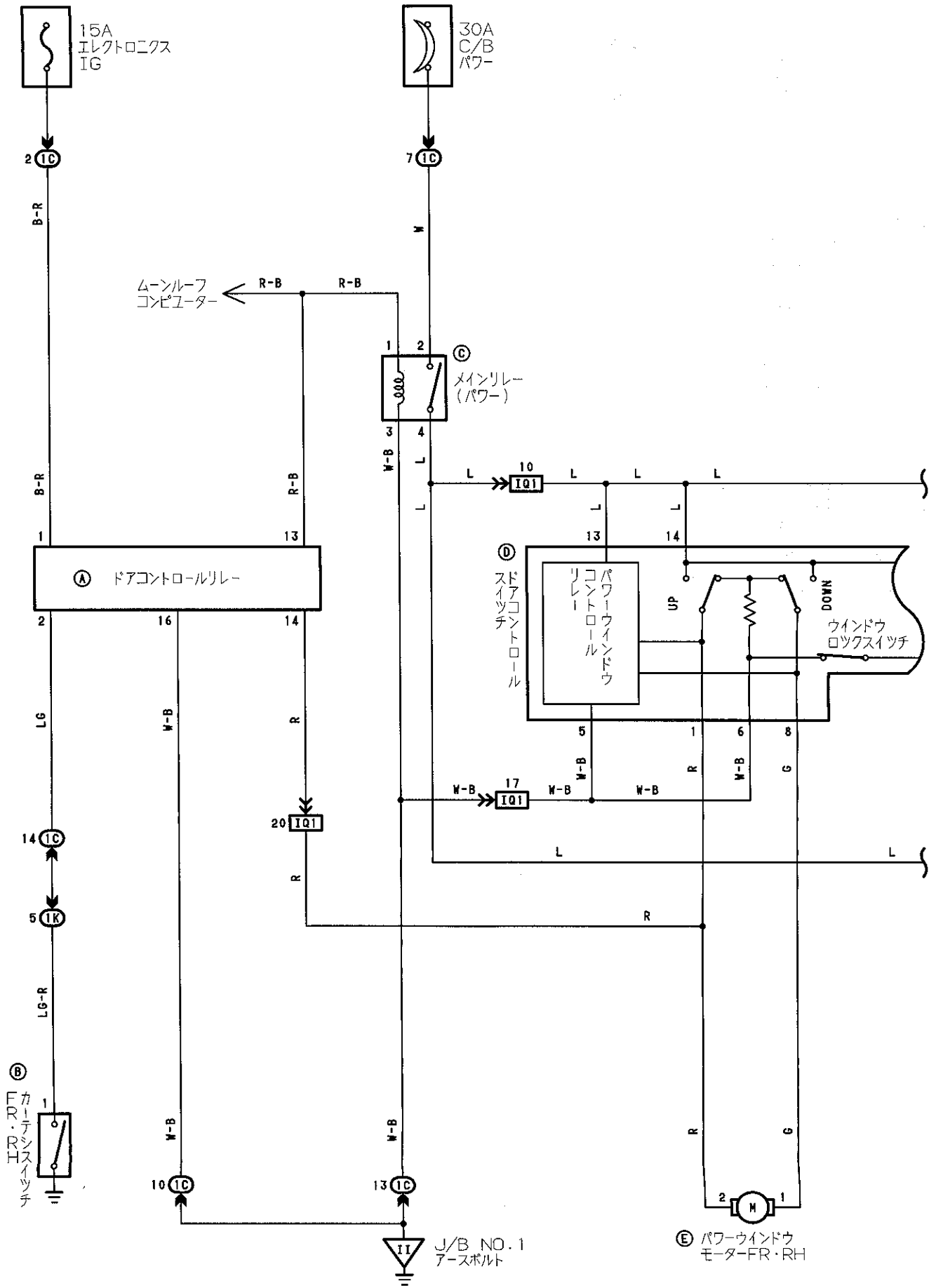

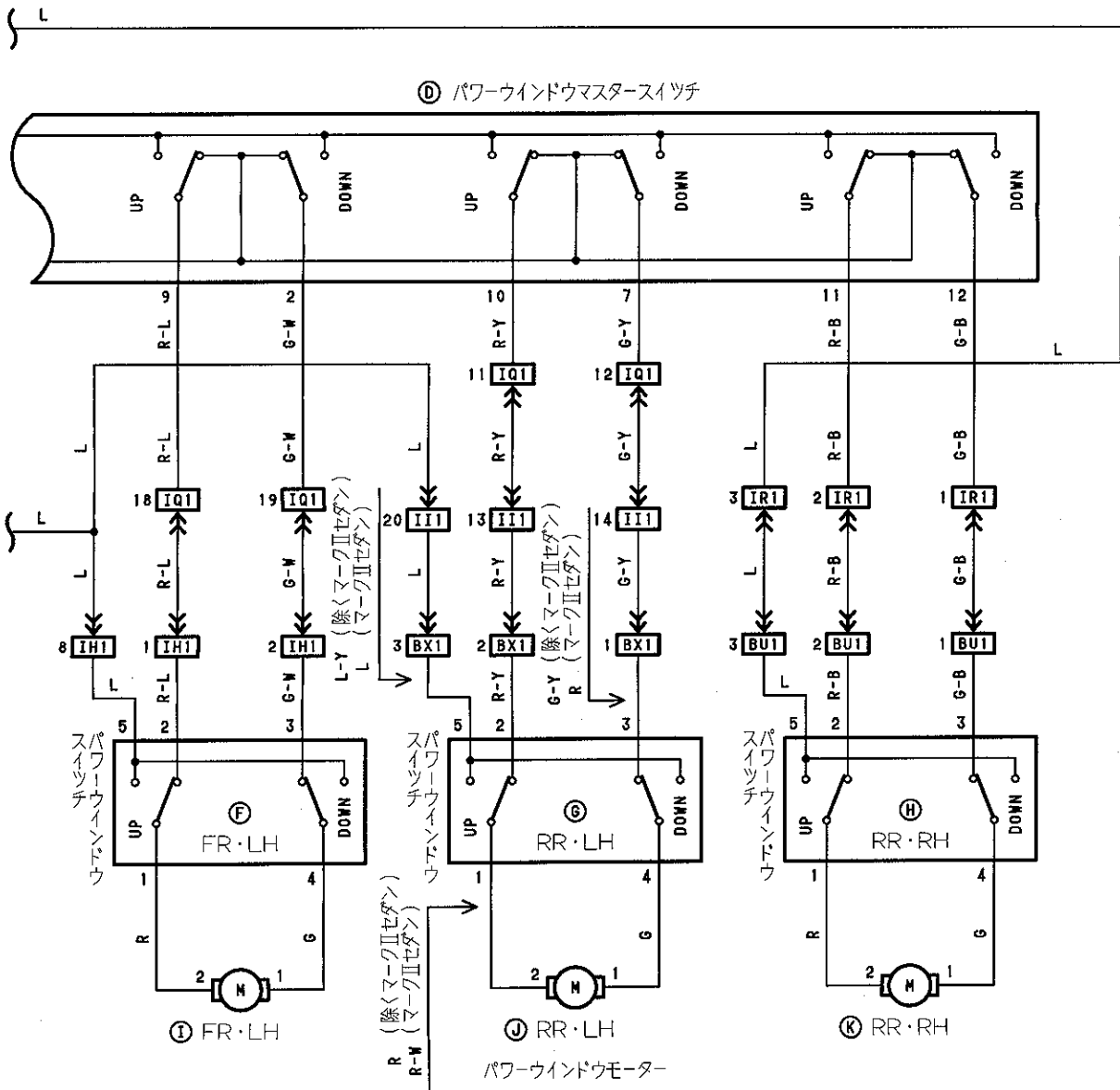

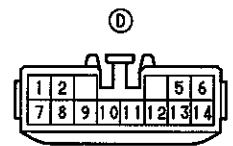
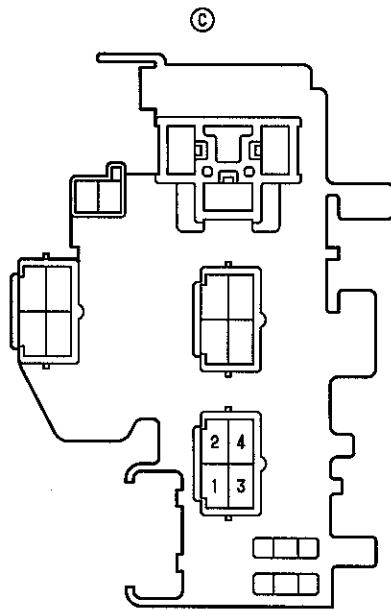
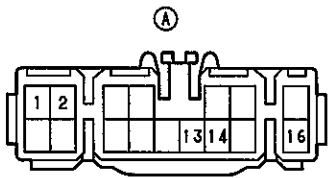

(J/B NO.1カセット)

(E) (I) (J) (K)



(F) (G) (H)



(I) (C)

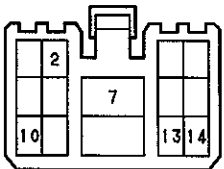

(I) (K)

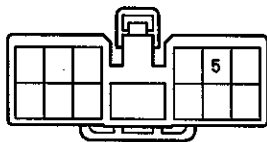

(II) (I) 青色

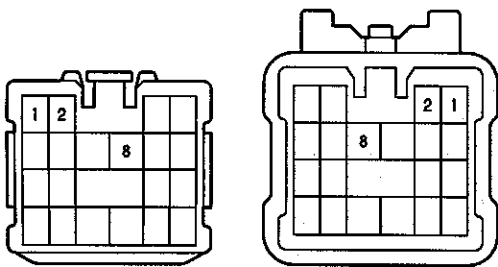

(II) (I)

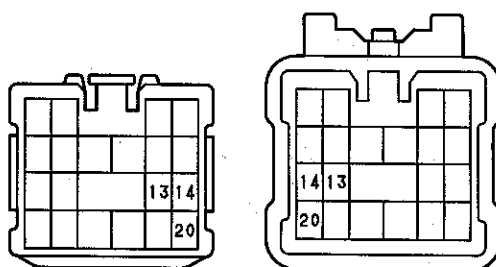



IQ1 青色

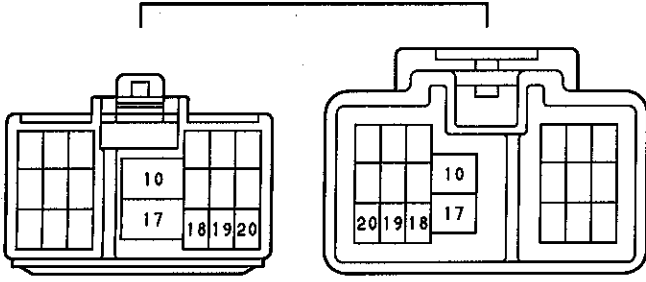

IR1 青色

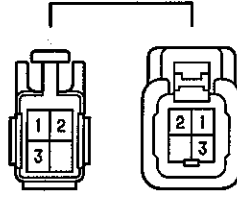

BU1 **BX1** 青色

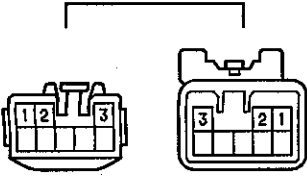



- △ キーレス付き
- キーレスなし
- オートドアロック付き

① ドアコントロールリレー

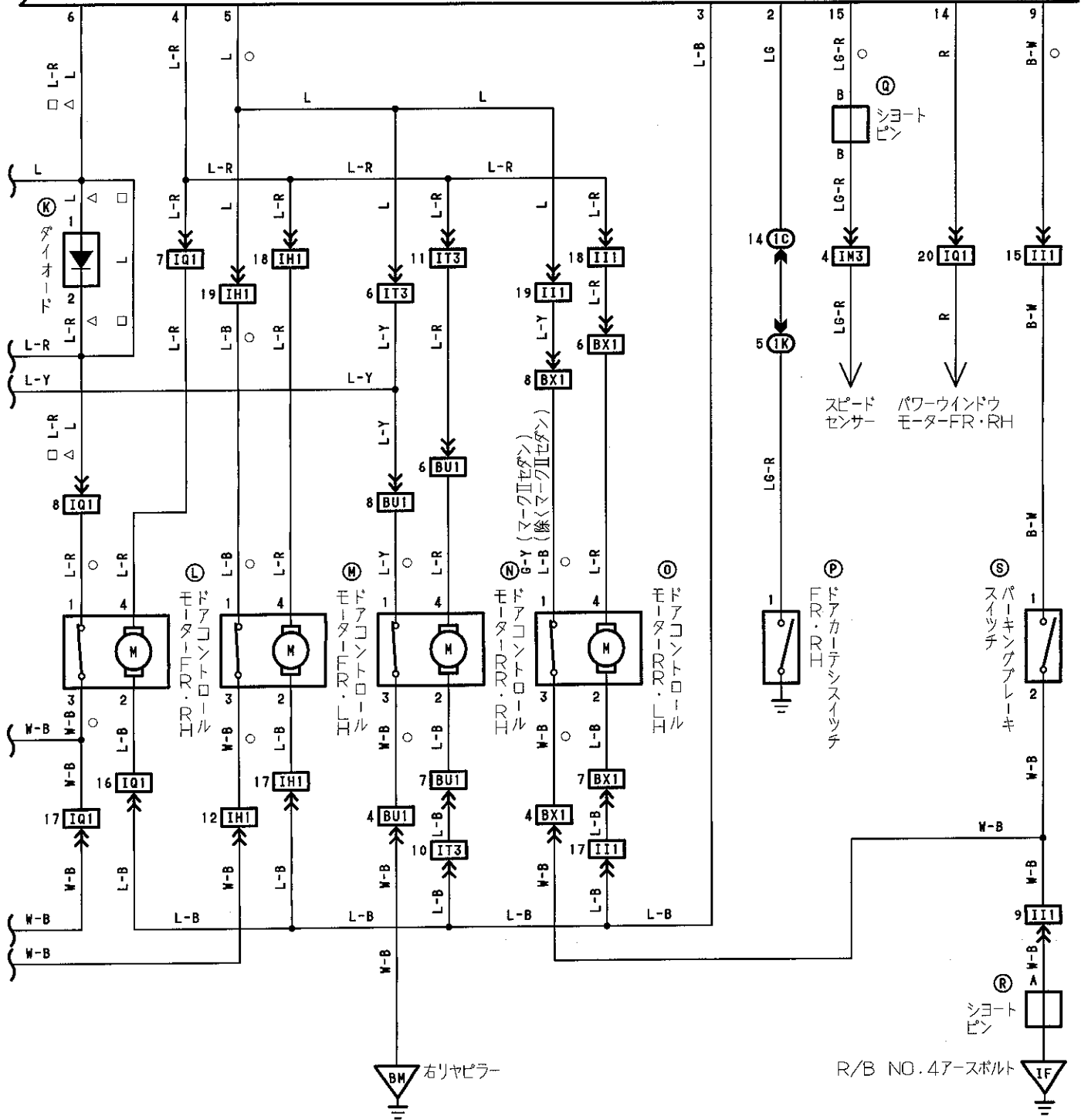

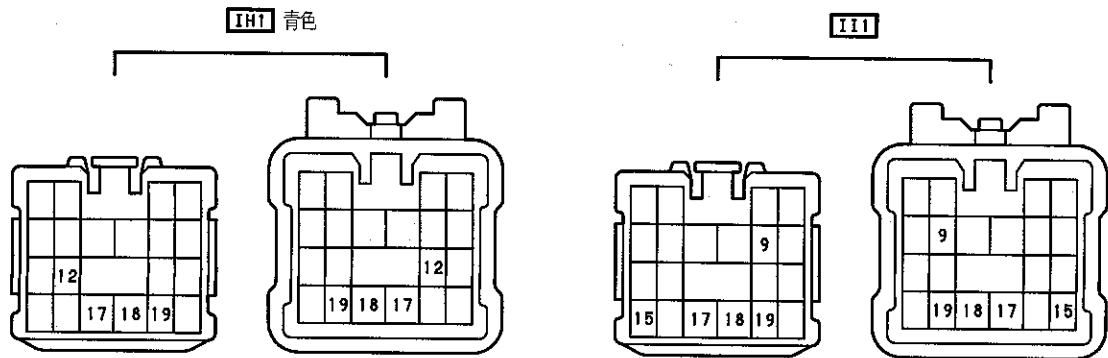
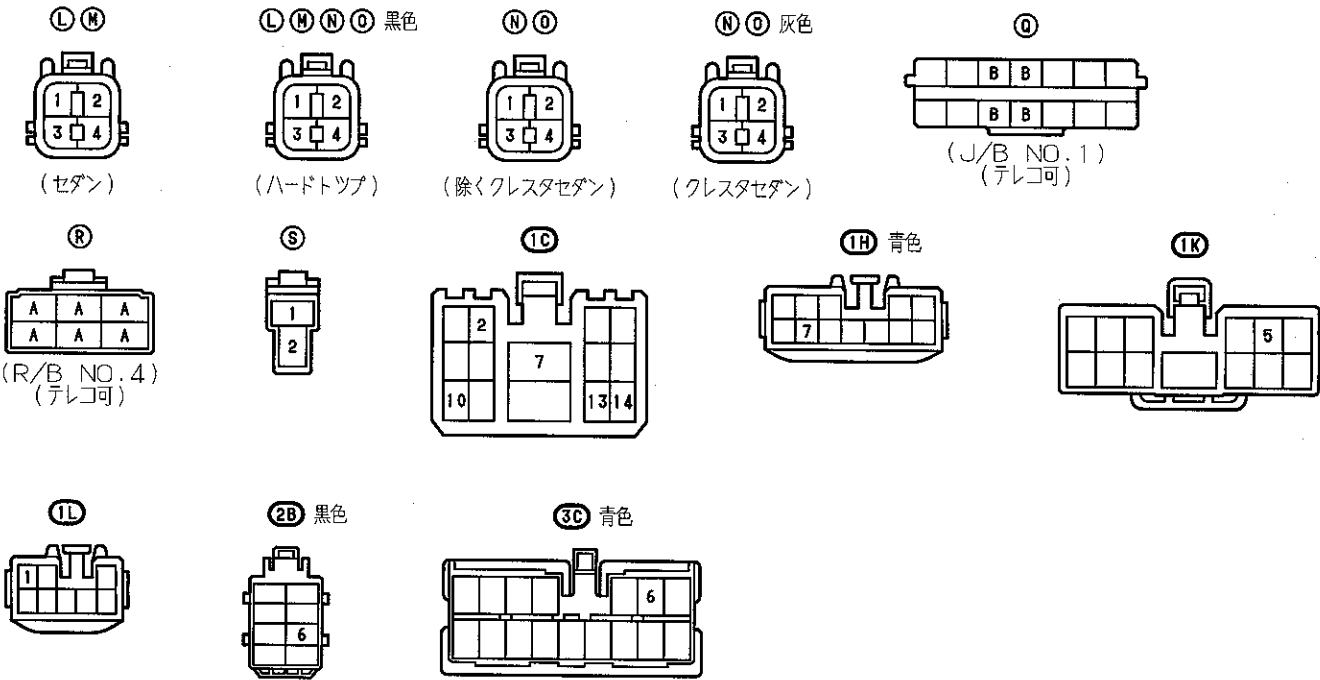
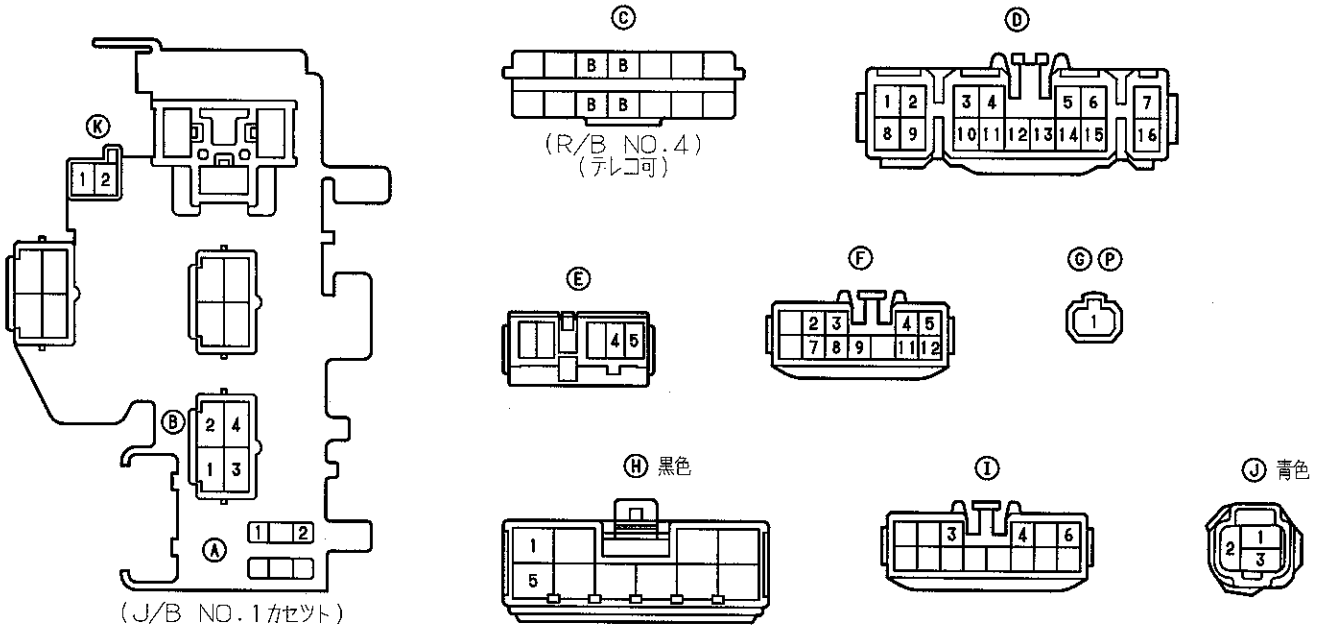



IM3

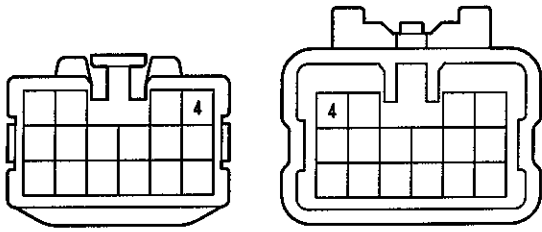

IQ1 青色

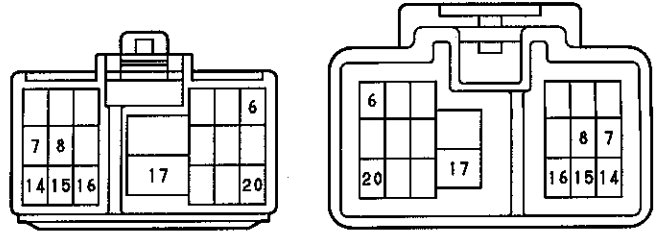

IS3 だいたい色

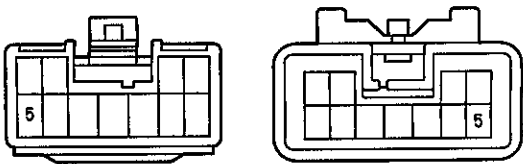

IT1 灰色

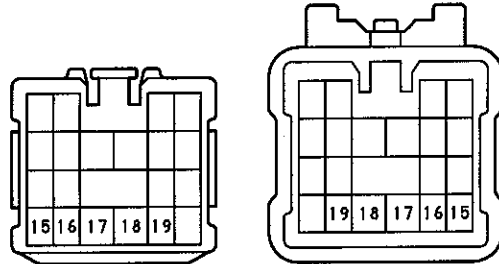

IT3

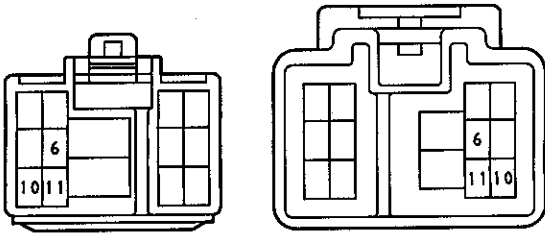

IT4 灰色

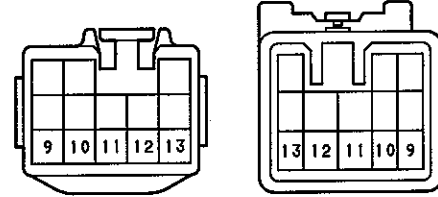

BU1 BX1 青色

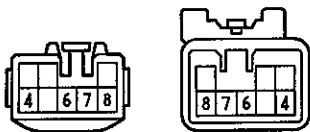

Bc1 黒色

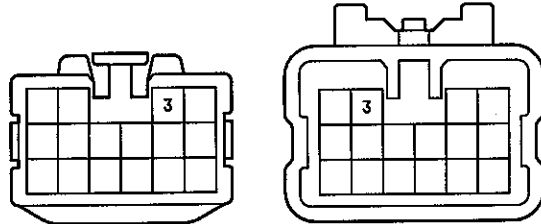

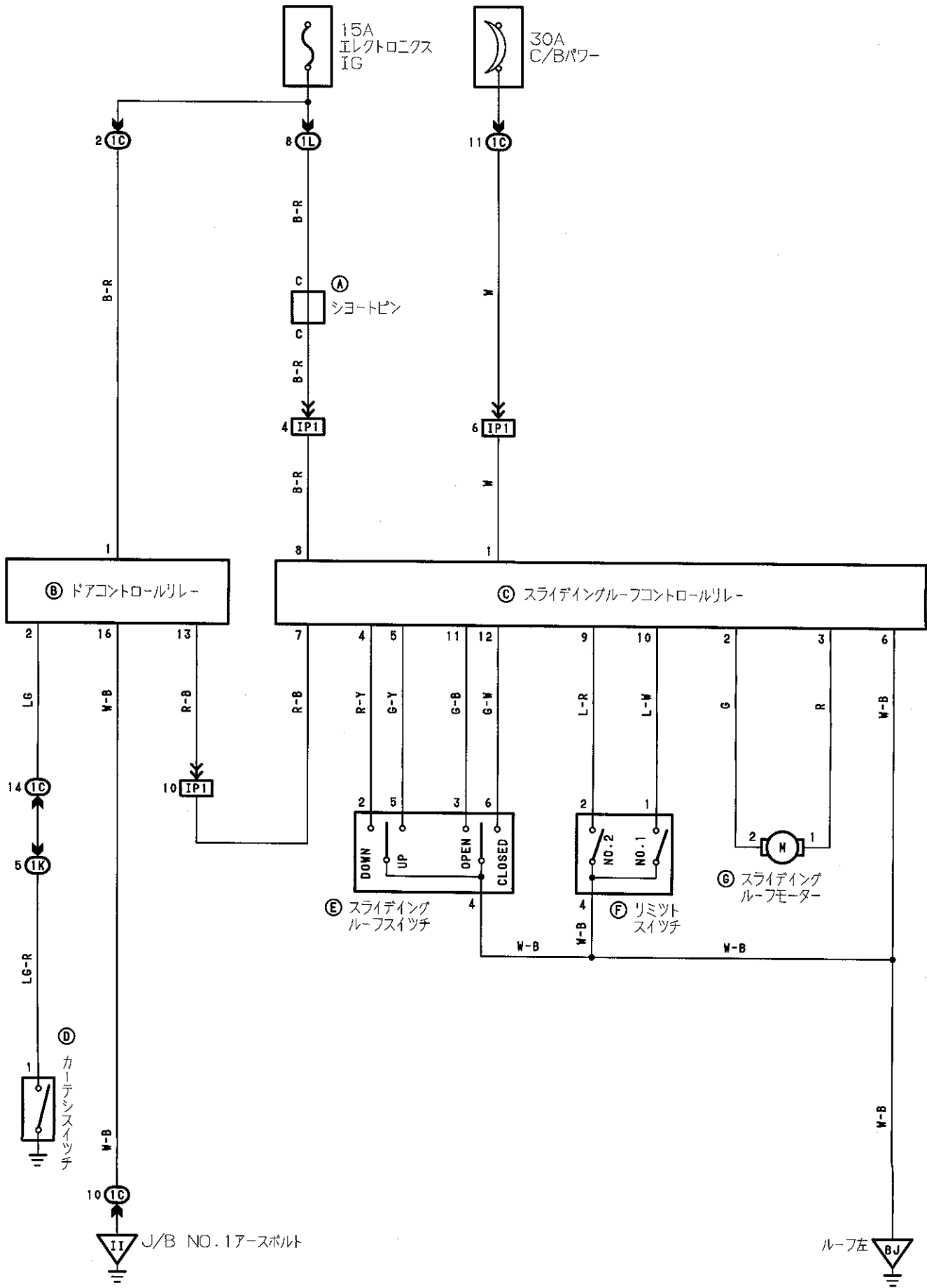

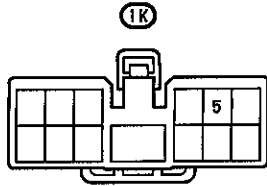
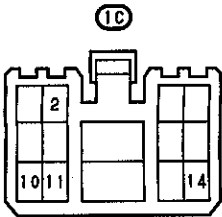
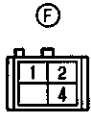
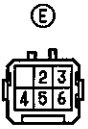
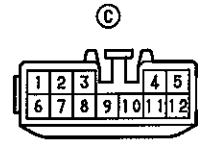
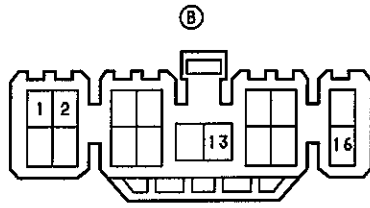
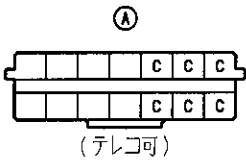

IP1 だいたい色

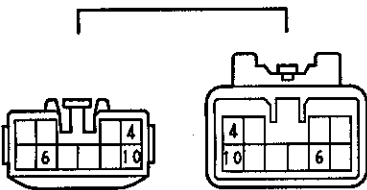

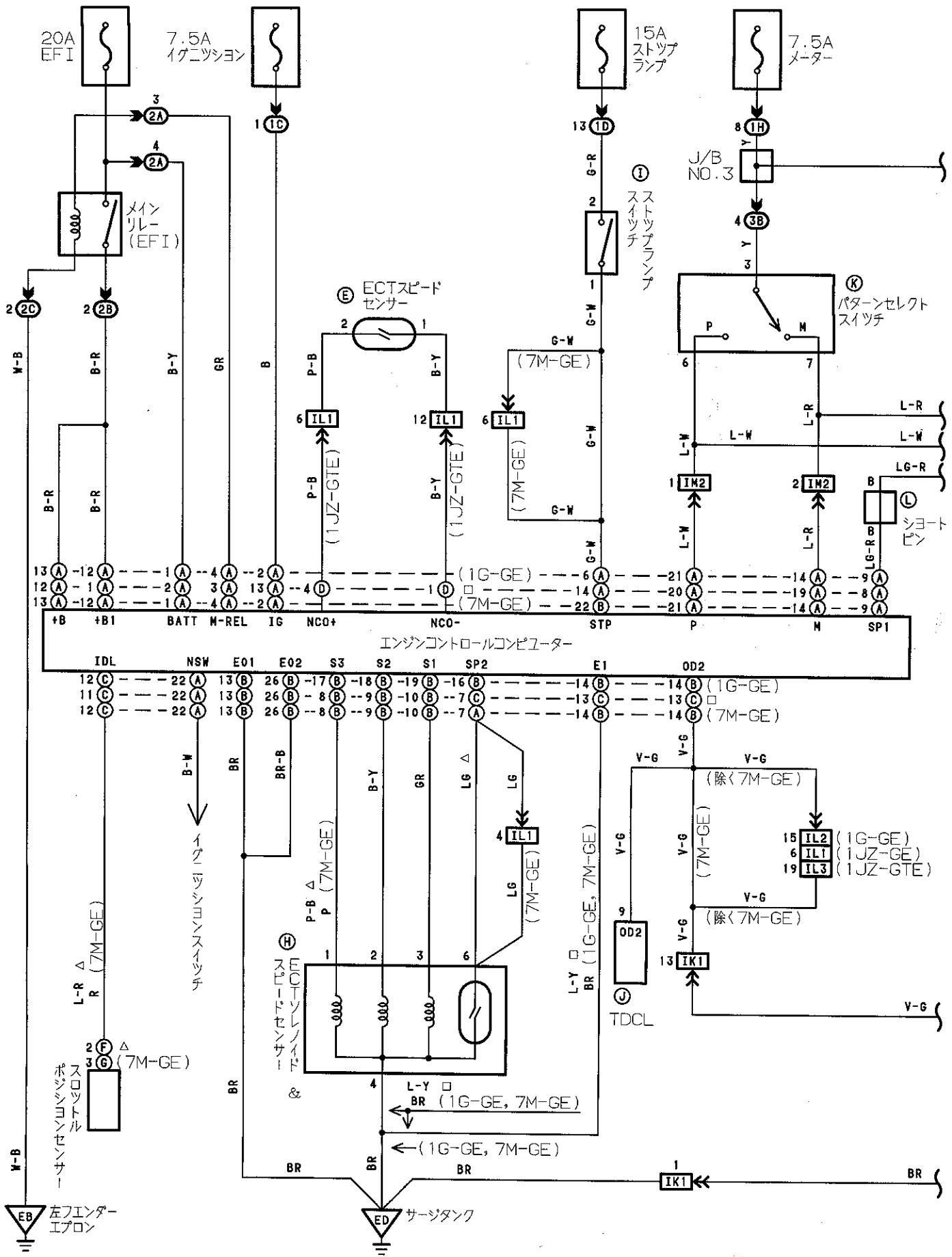

△ 1G-GE, 1JZ-GE, 1JZ-GTE
 □ 1JZ-GE, 1JZ-GTE

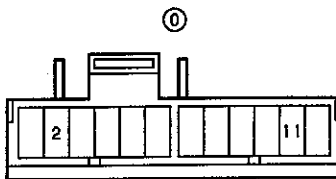
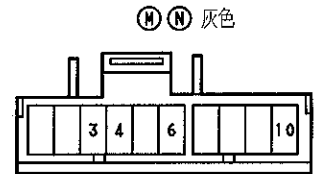
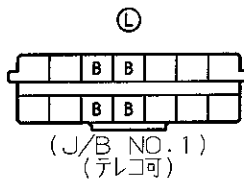
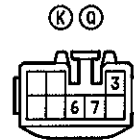
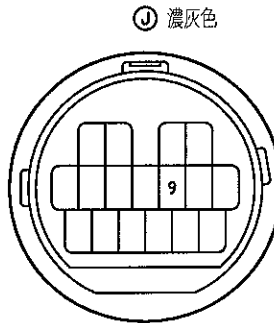
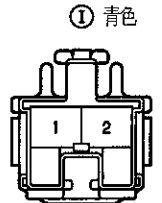
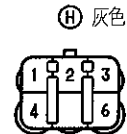
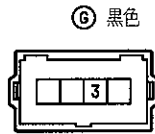
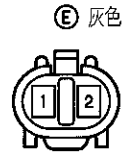
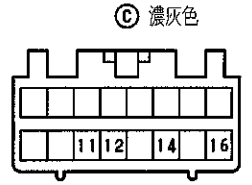
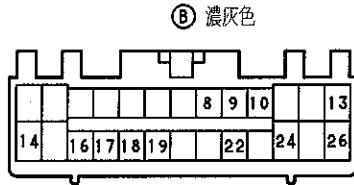
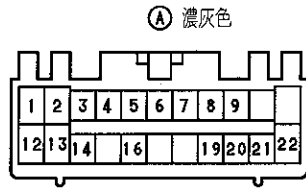
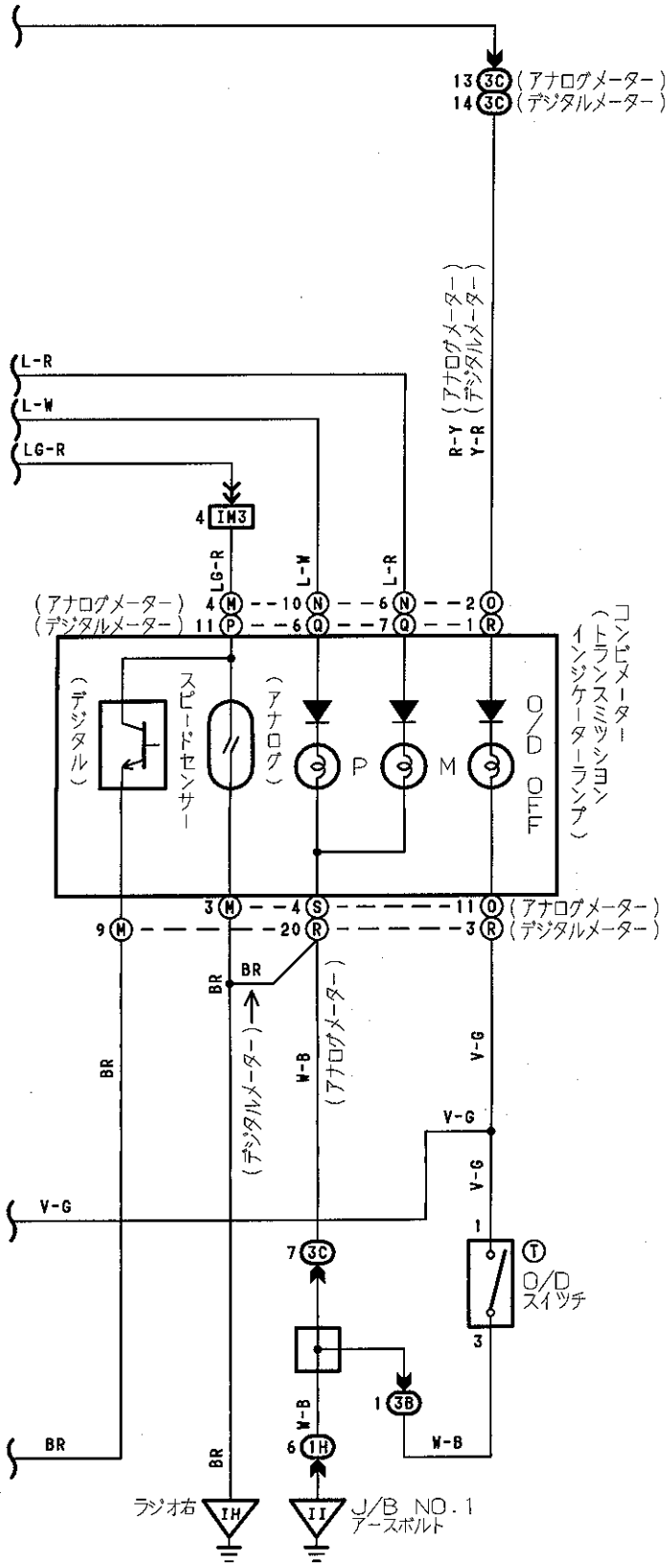

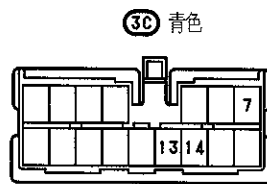
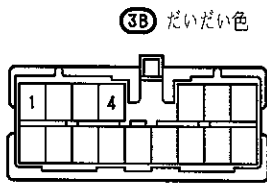
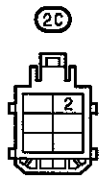
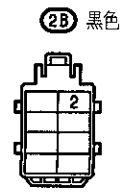
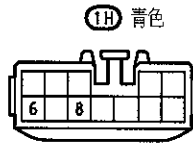
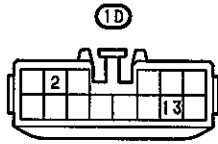
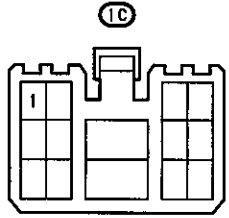
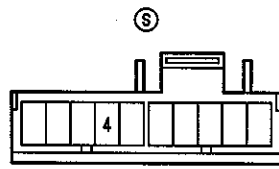
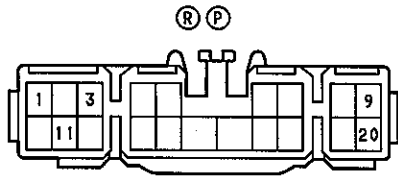

IL1 濃灰色

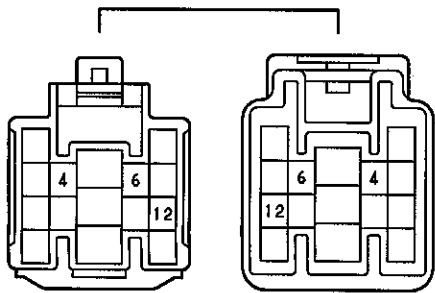

IL2 濃灰色

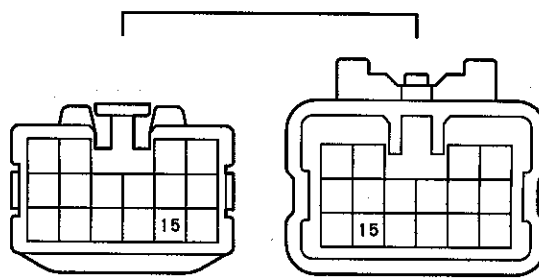

IL3 濃灰色

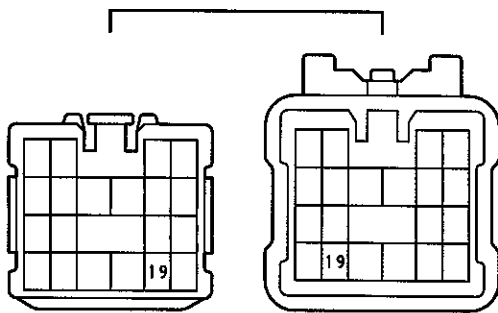

IM2

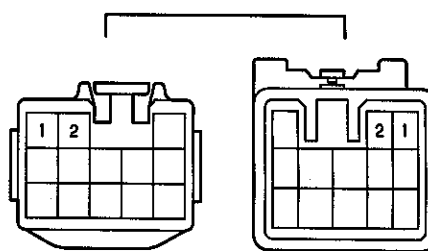

IK1 IN3

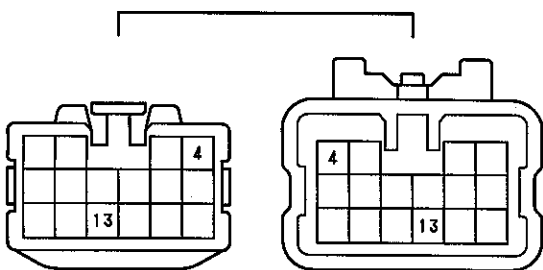

◇ 4S-FE以下
□ 1G-FE以上

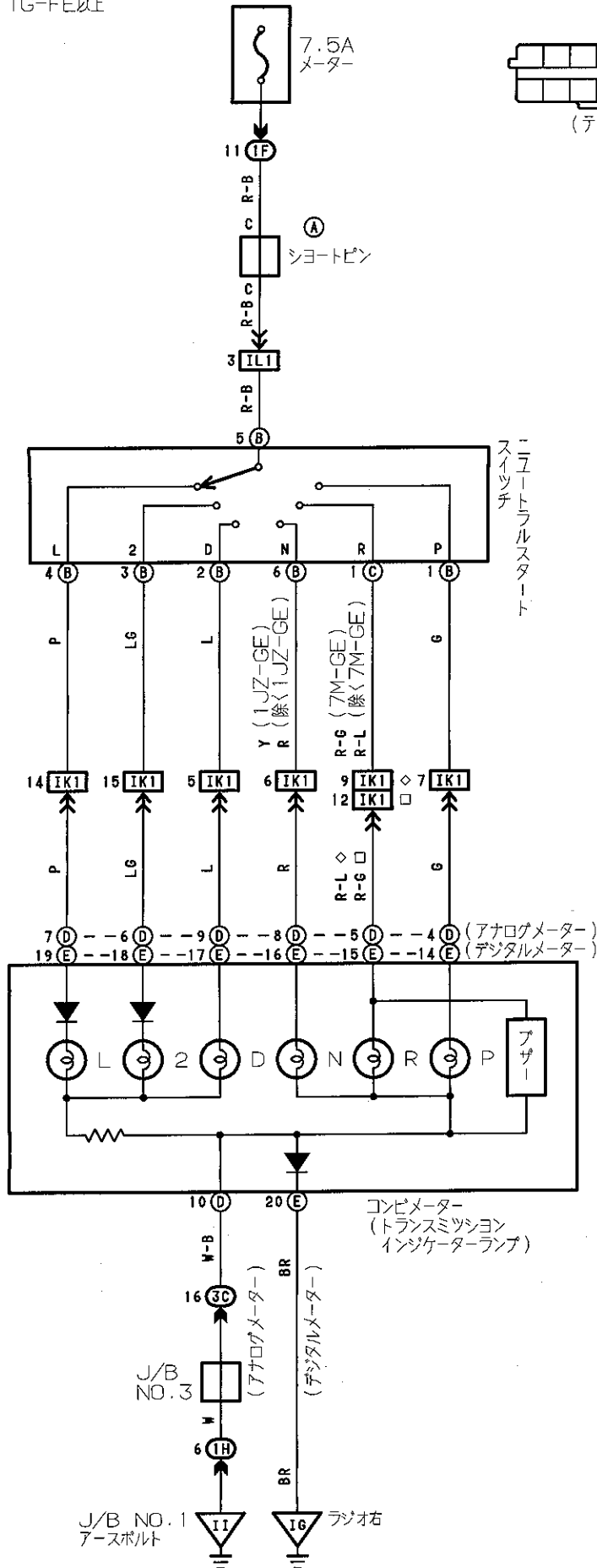

ニュートラルスタート
スイッチ

コンビメーター
(トランスミッション
インジケータランプ)

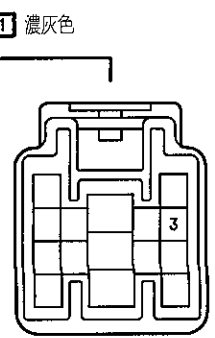
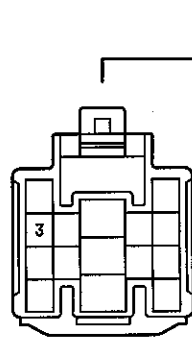
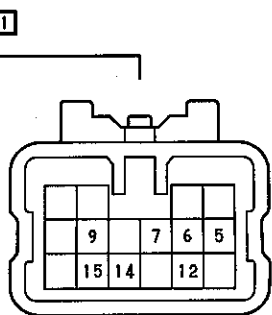
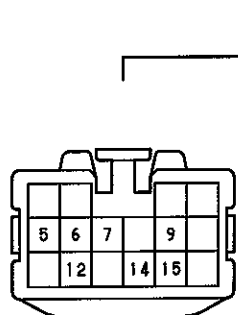
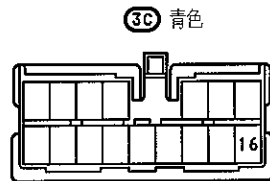
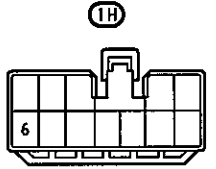
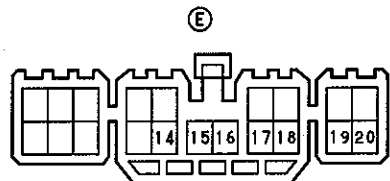
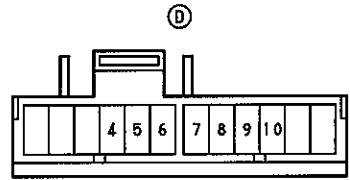
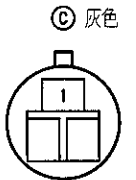
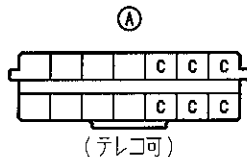

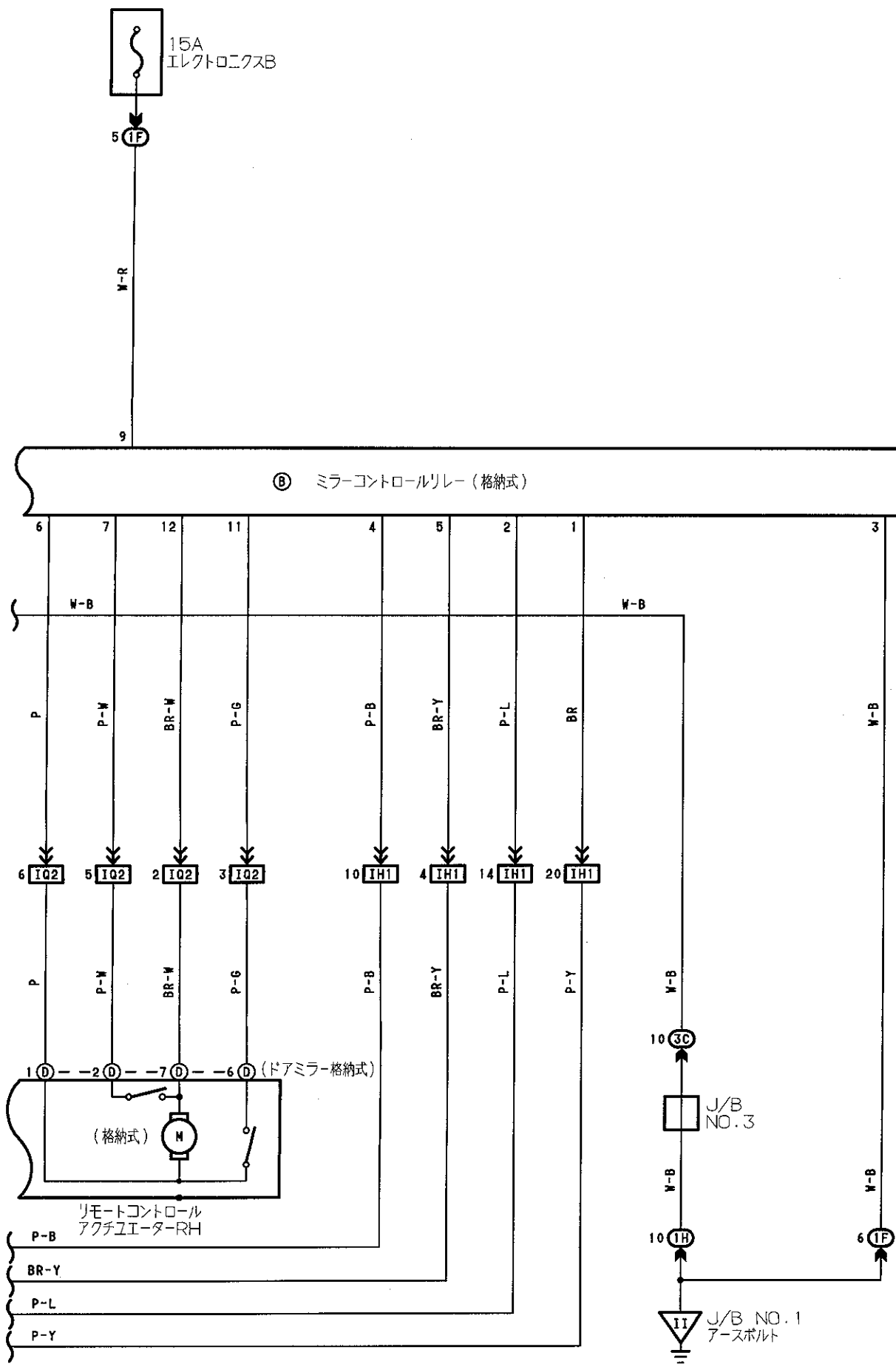

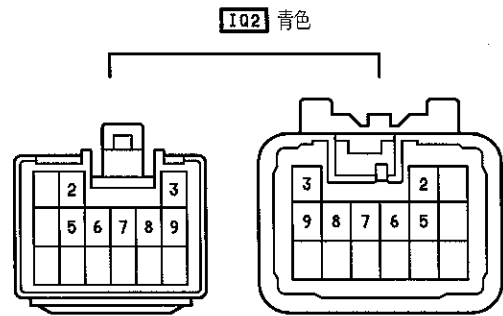
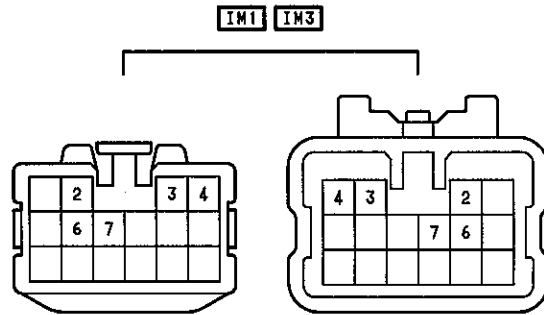
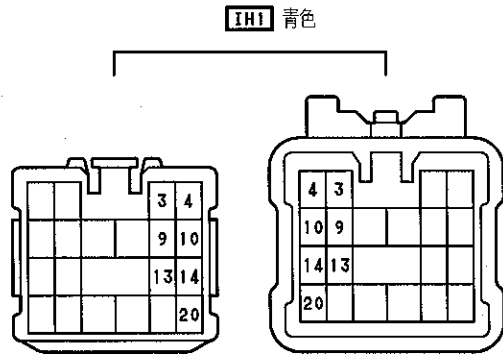
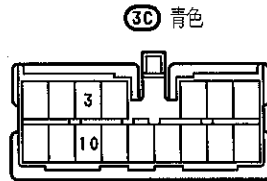
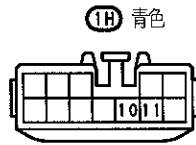
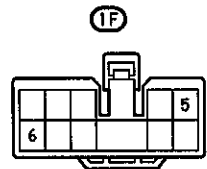
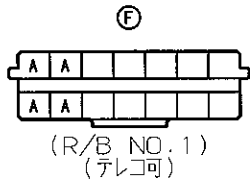
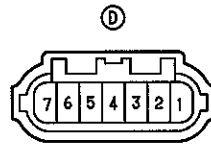
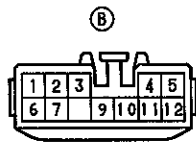
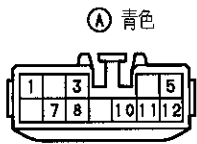

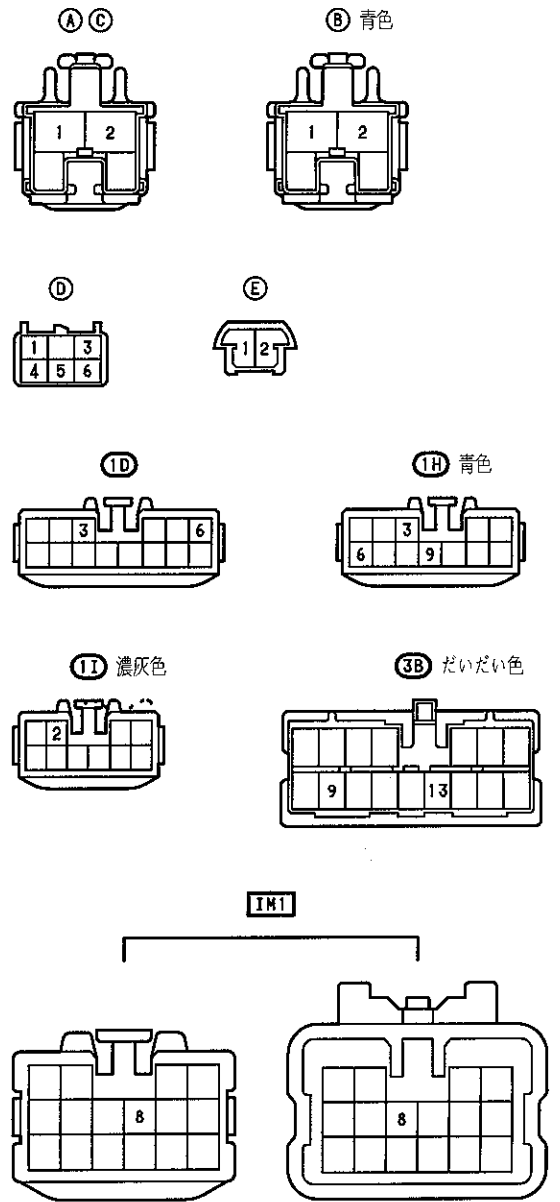
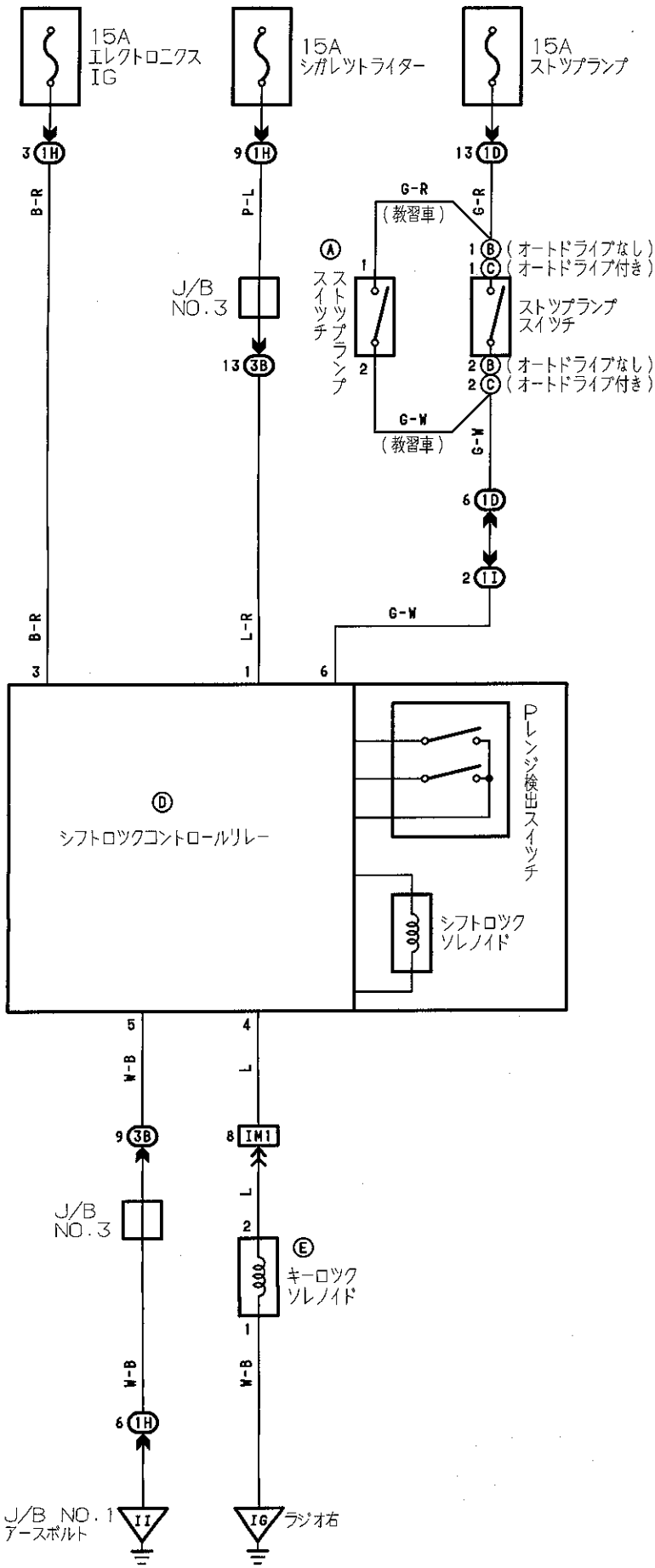

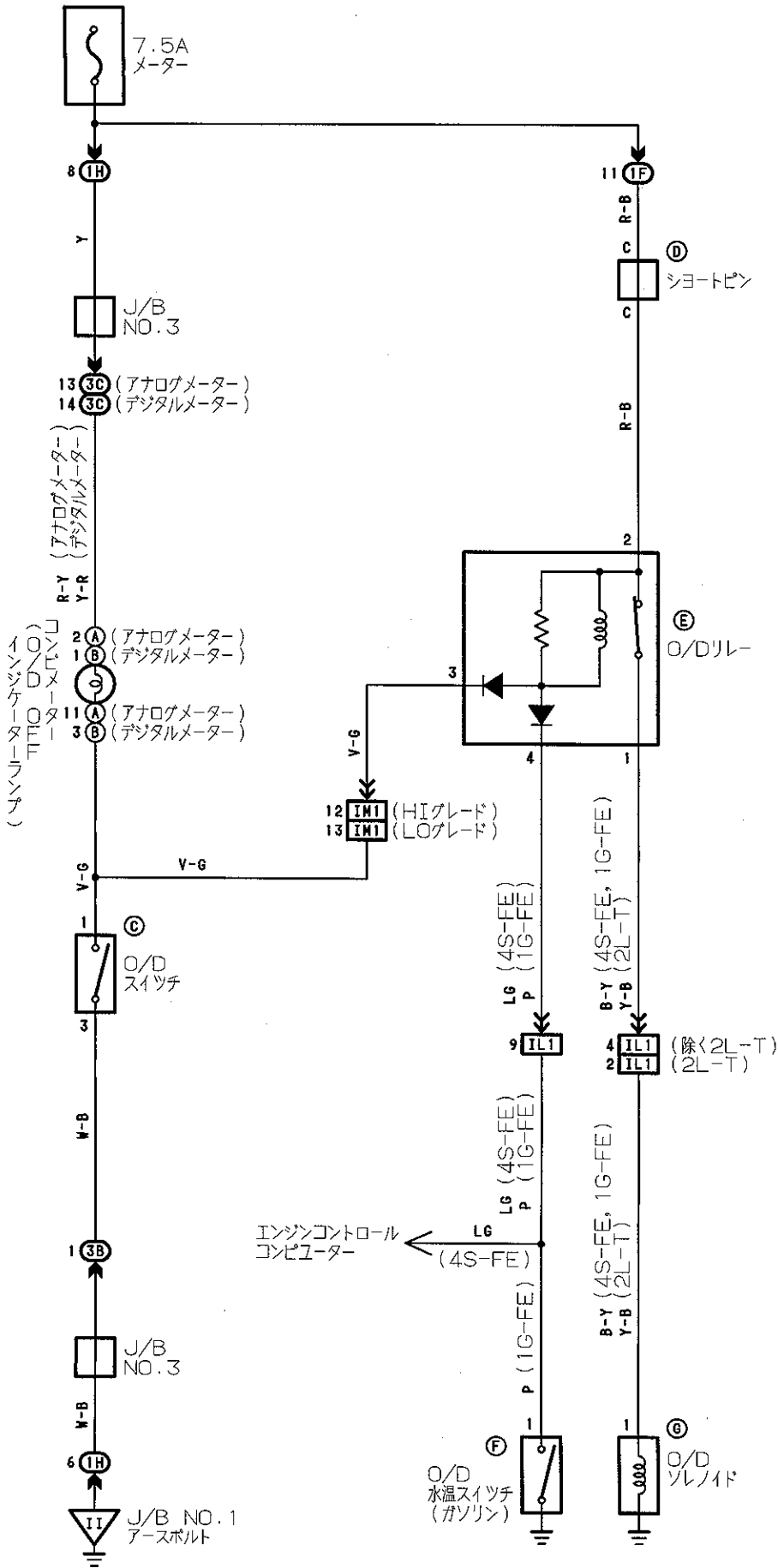

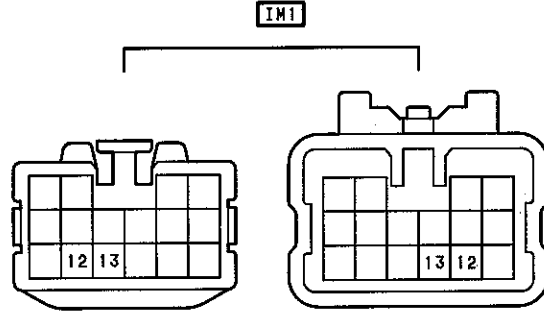
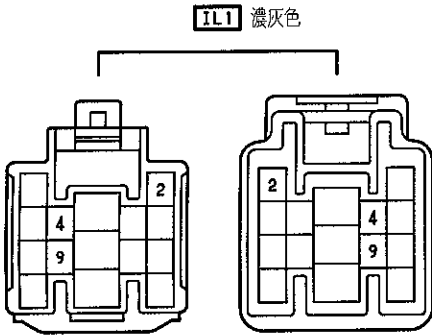
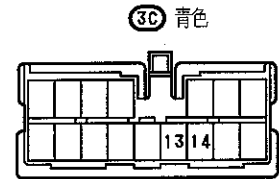
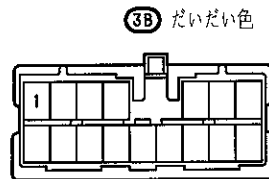
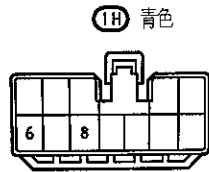
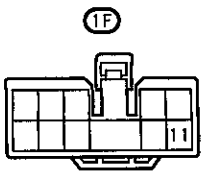
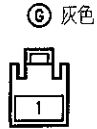
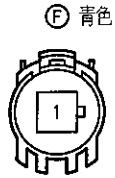
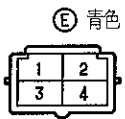
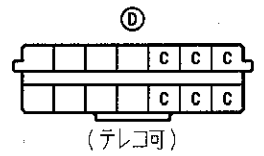
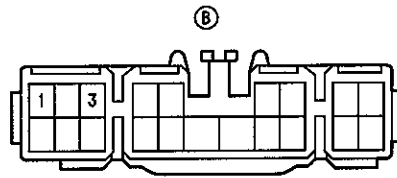
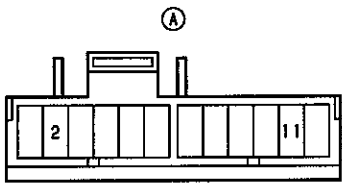

- 7M-GE
- △ 1JZ-GE
- 1JZ-GTE

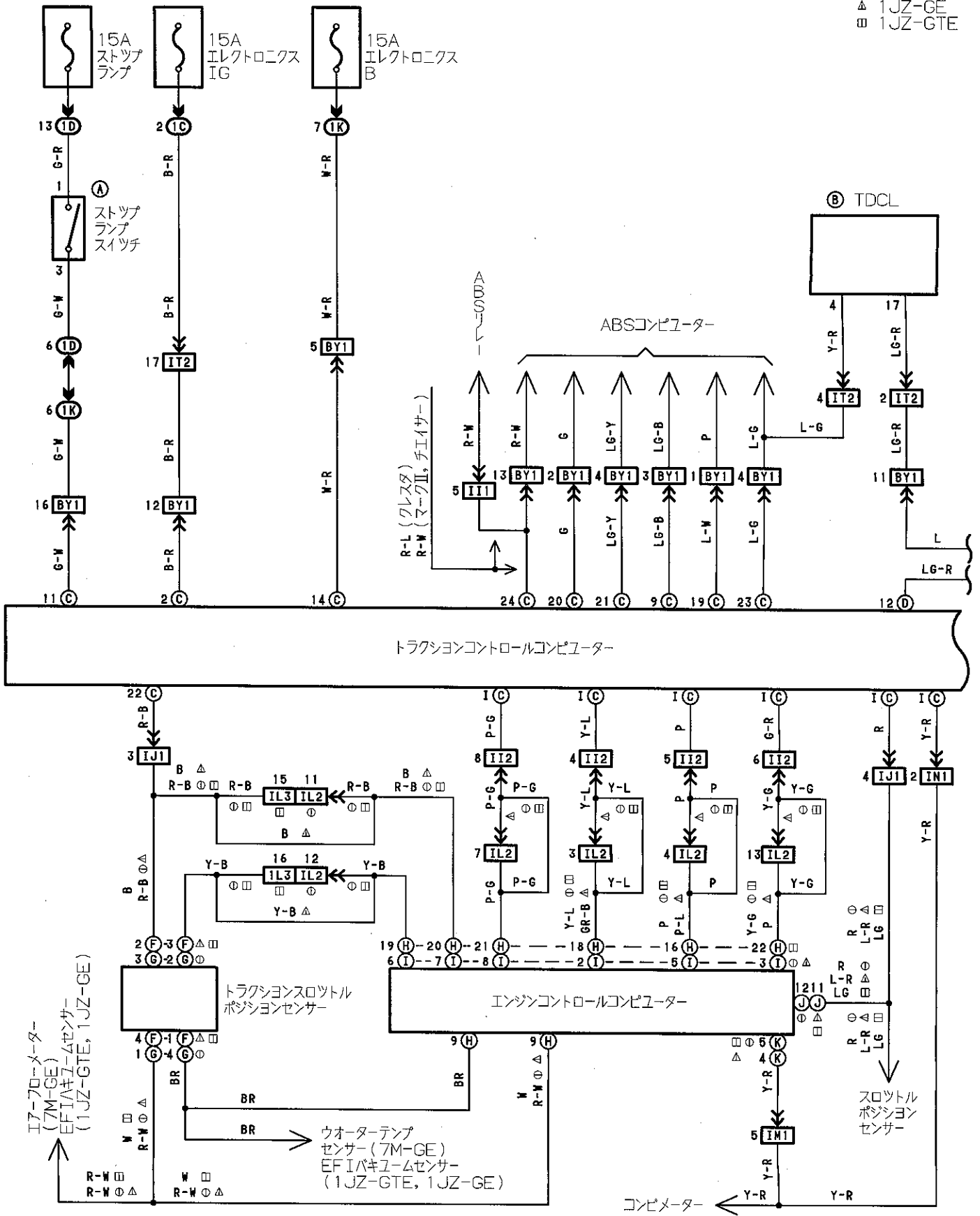

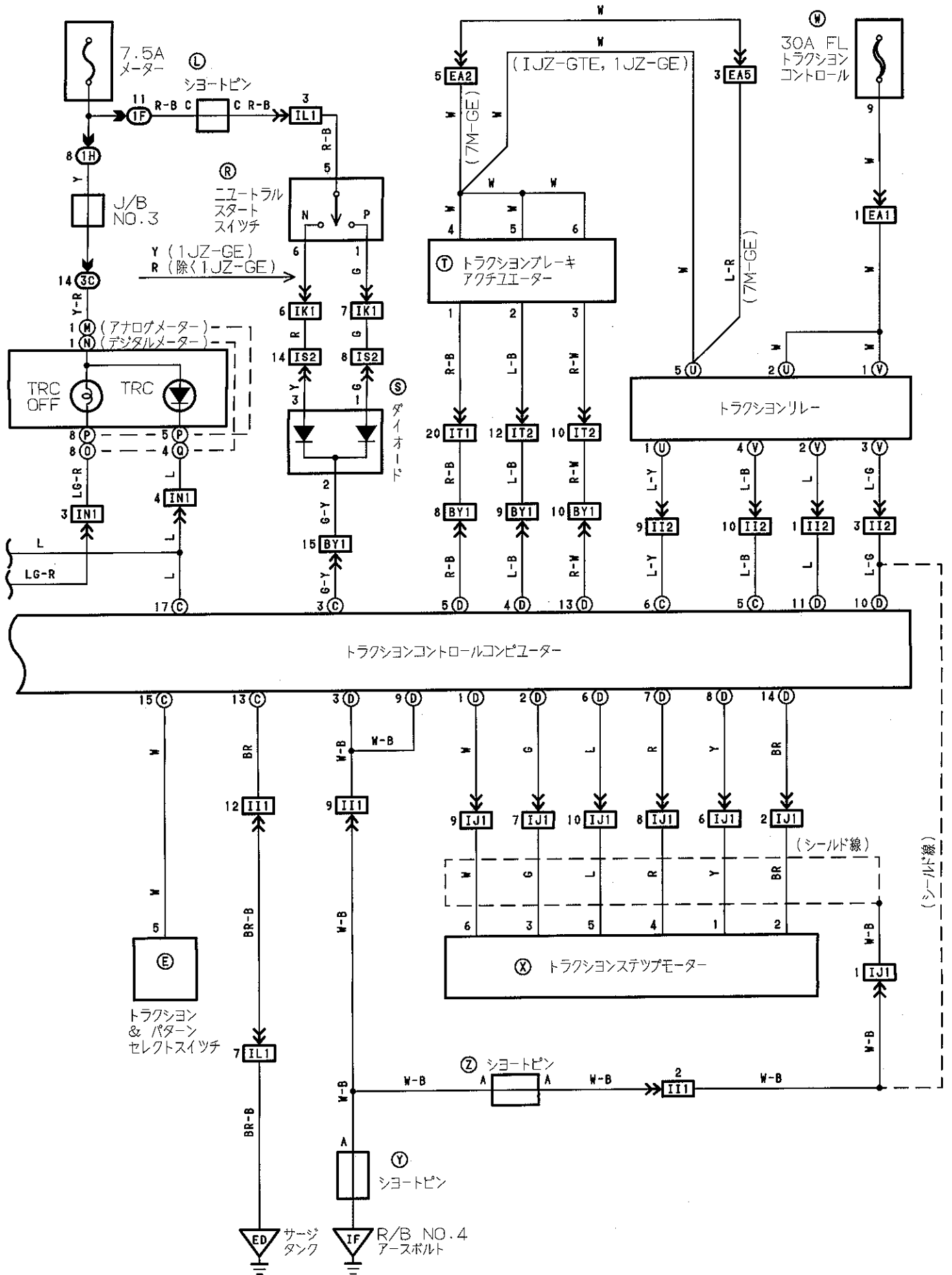

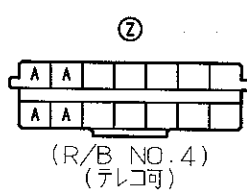
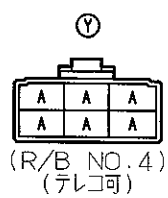
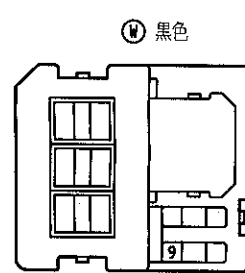
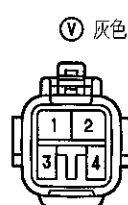
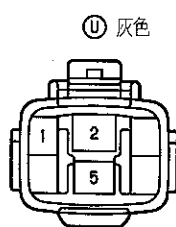
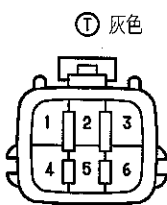
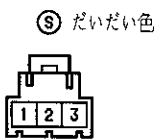
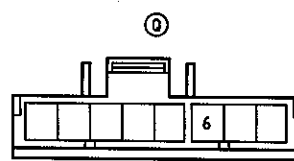
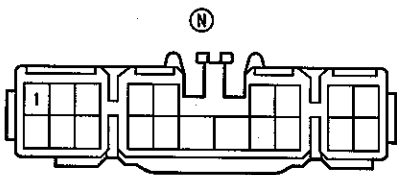
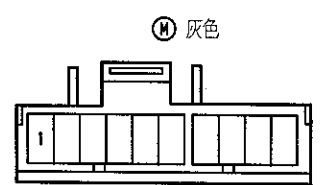
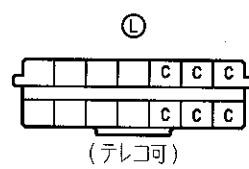
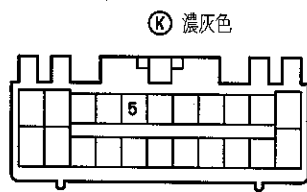
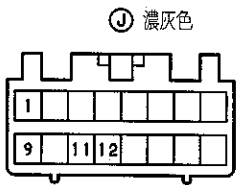
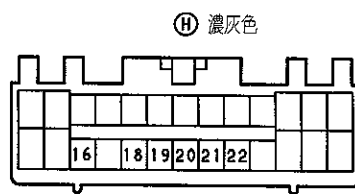
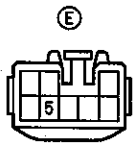
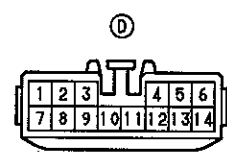
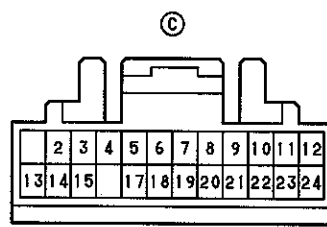
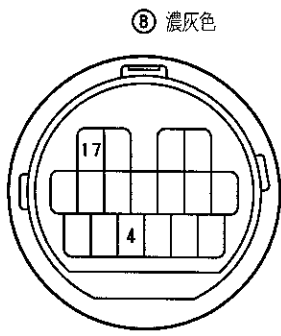
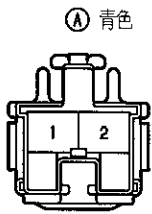

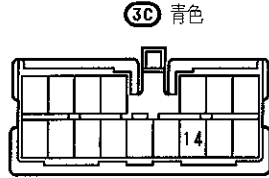
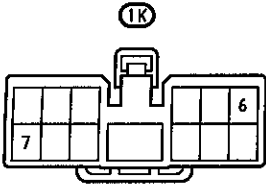
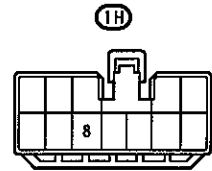
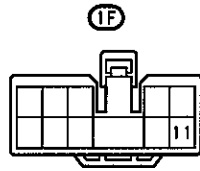
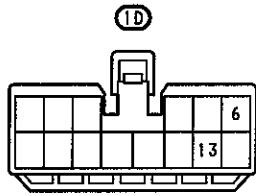
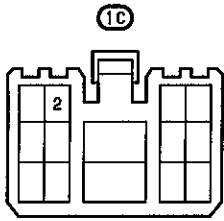

A6 A8

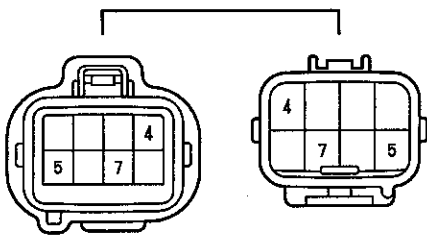

A9 灰色

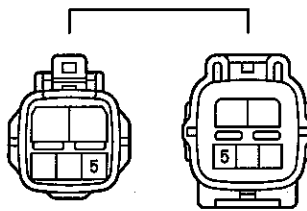

F1 F4 濃灰色

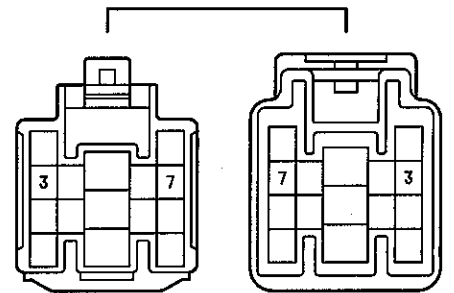

F6 濃灰色

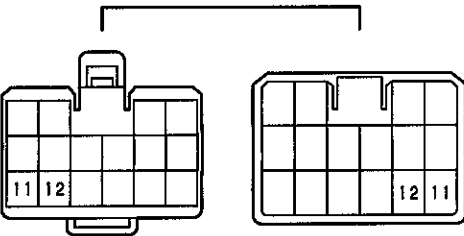

G2

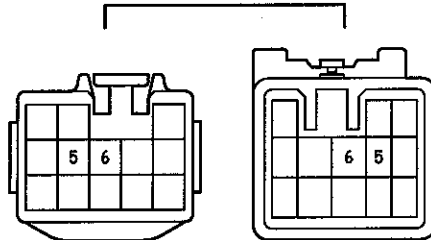

I3

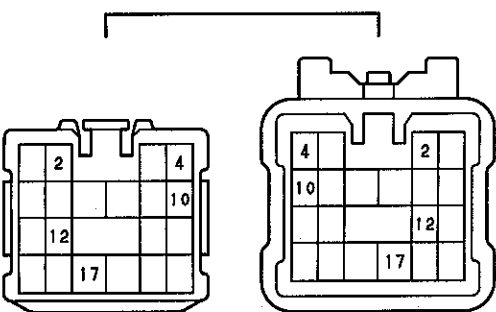

I4 濃灰色

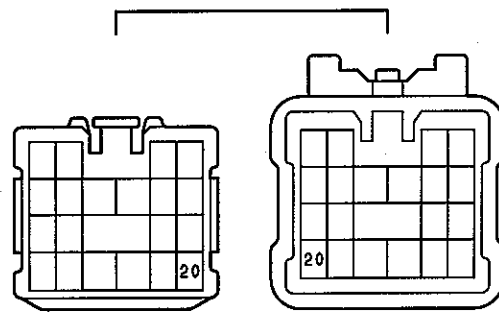

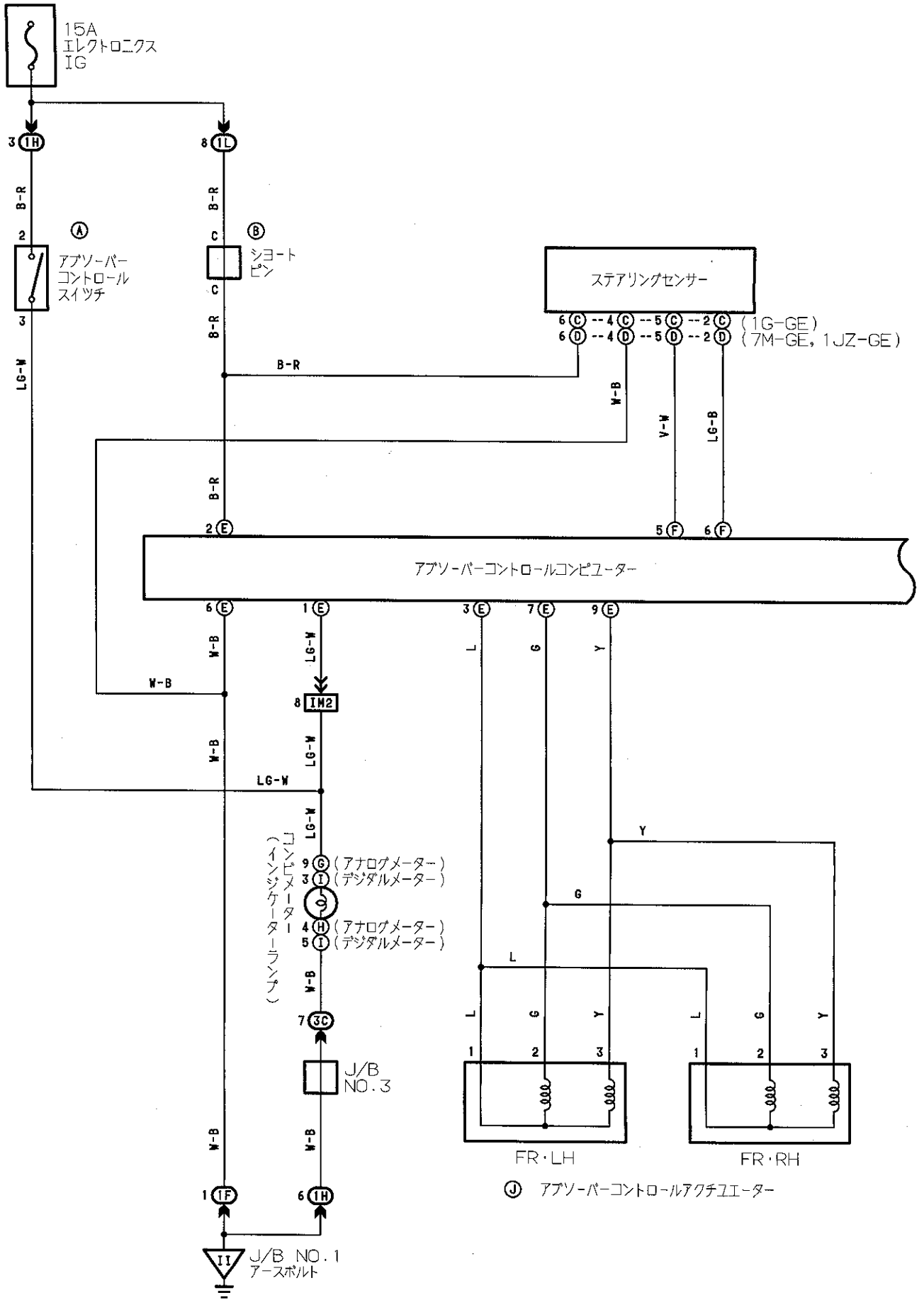

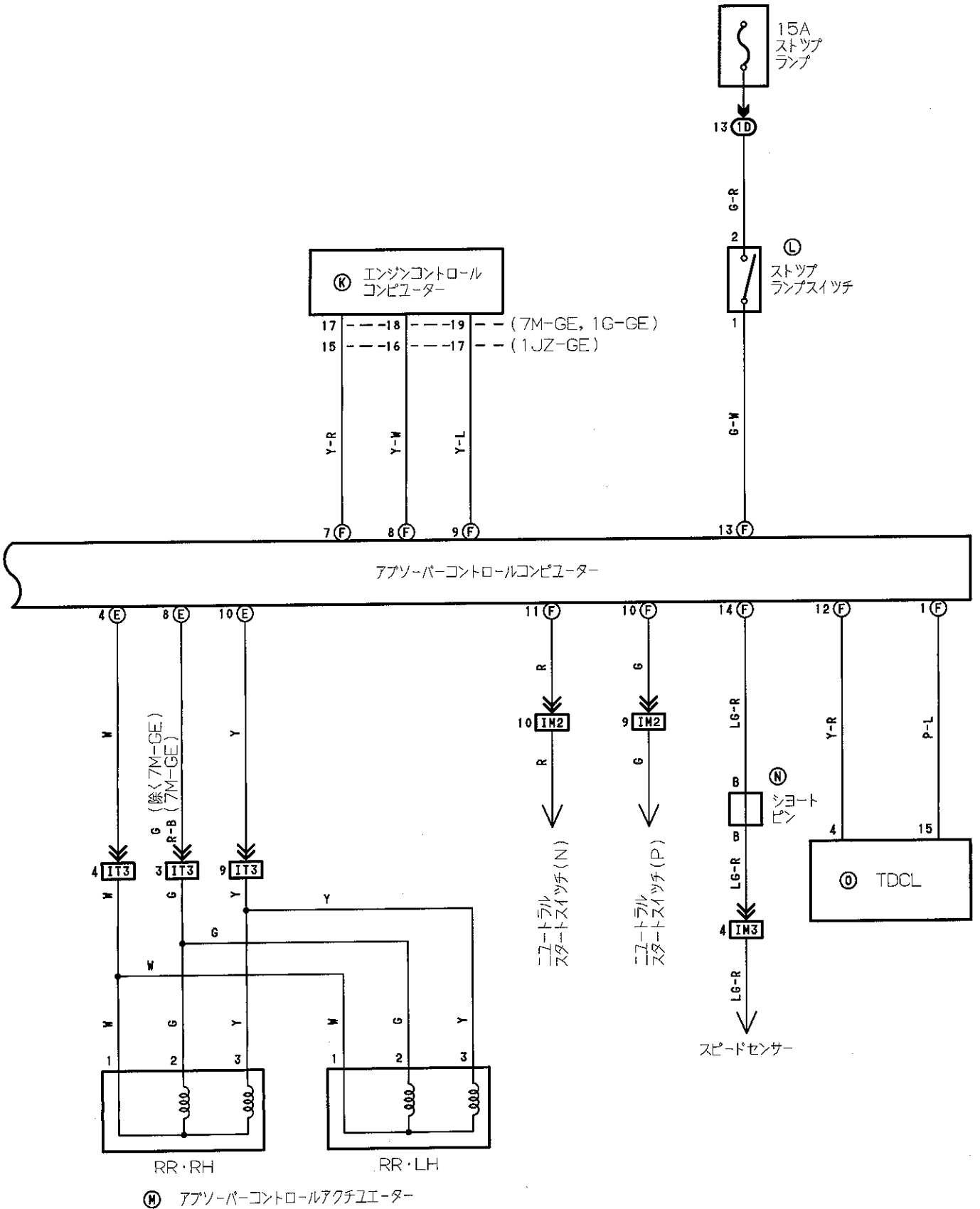

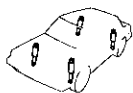

(A) 黒色

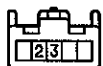

(B) (N)

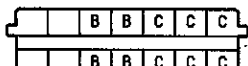

(テレコ可)

(C) 濃灰色又は無色



(D) 濃灰色



(E) 青色

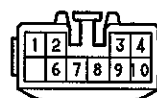

(F)

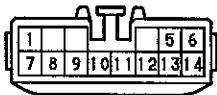

(G) 青色

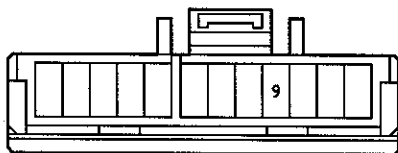

(H) 茶色

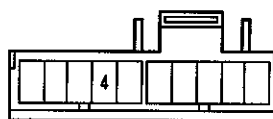

(I)

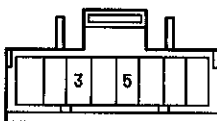

(J) 灰色



(K) 濃灰色

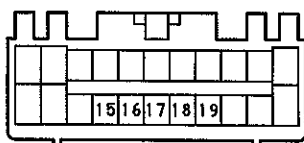

(L) 青色

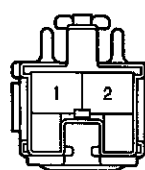

(M)



(N) 濃灰色

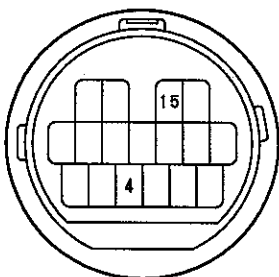

(1D)

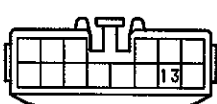

(1F)

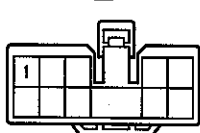

(1H) 青色

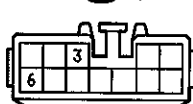

(1L)



(3C) 青色

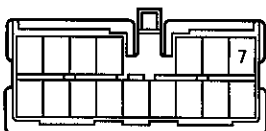

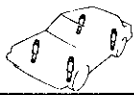

IM2

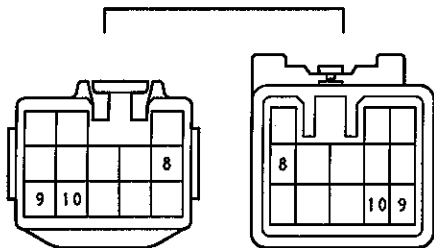

IM3

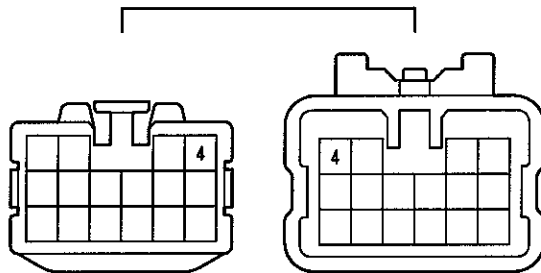

IT3

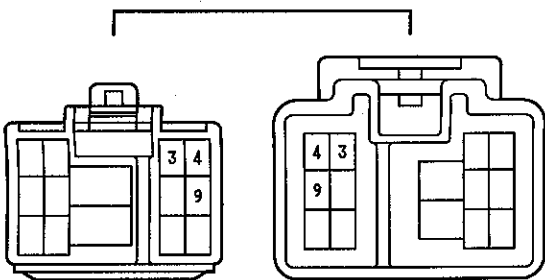

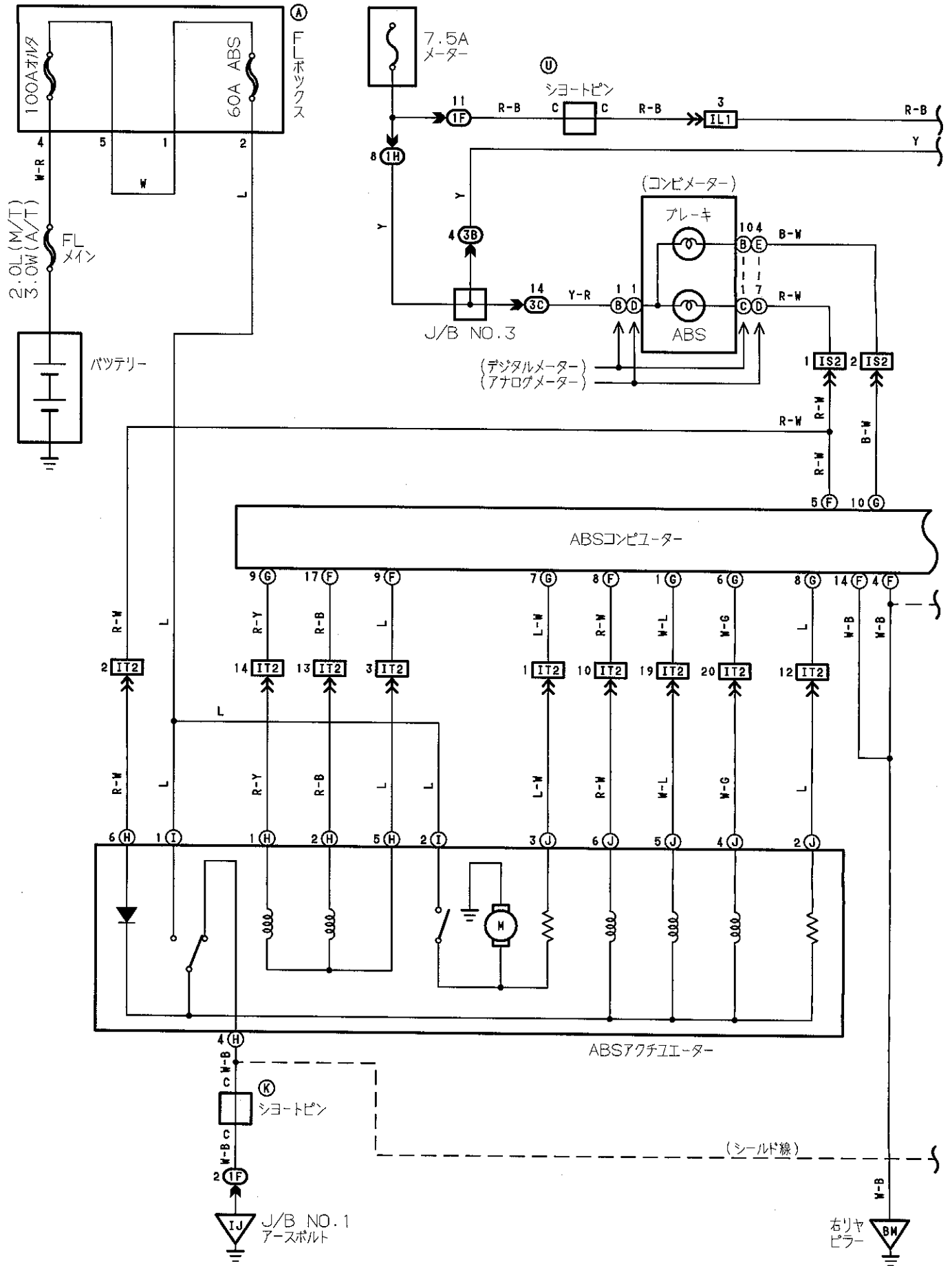

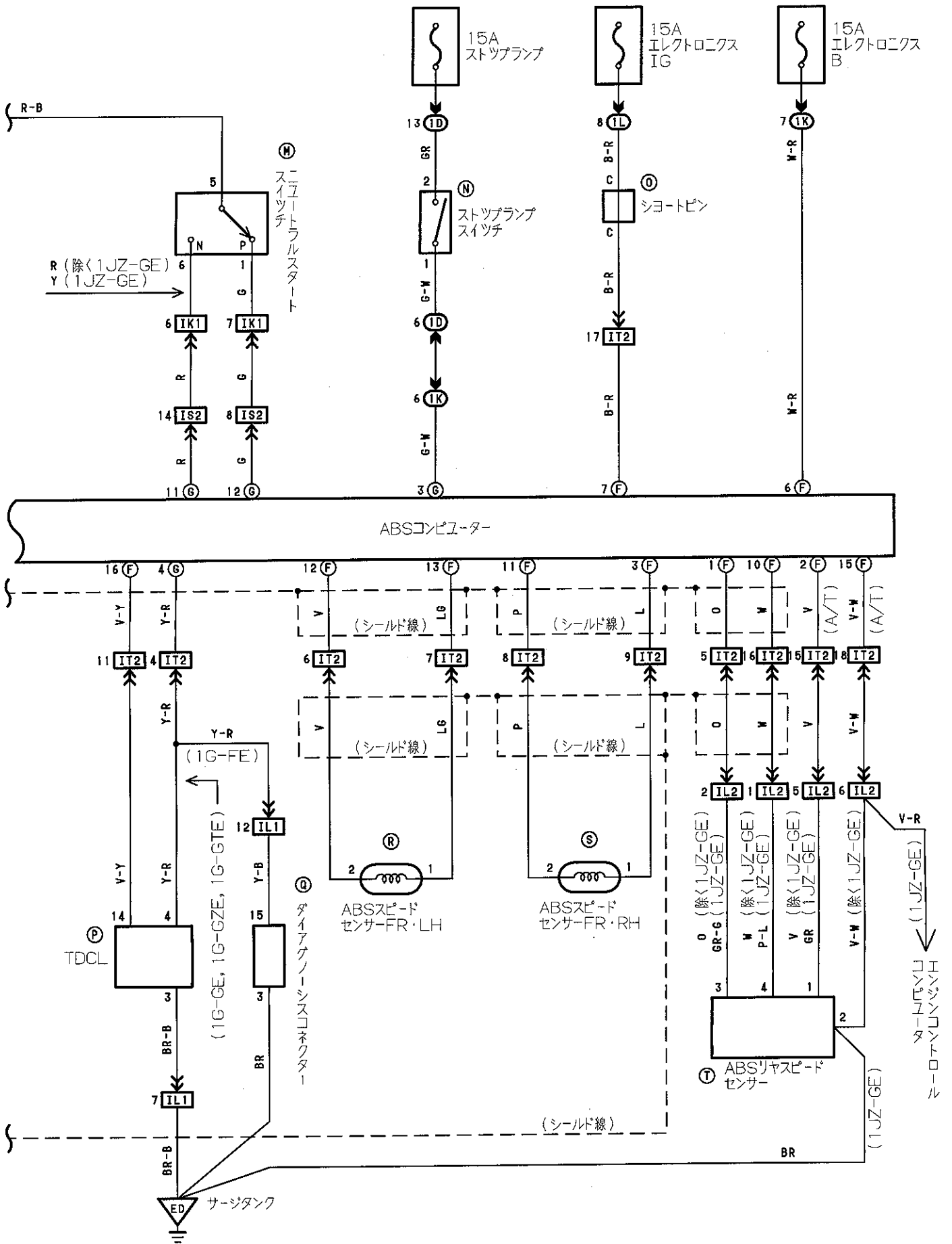



Ⓐ 黒色

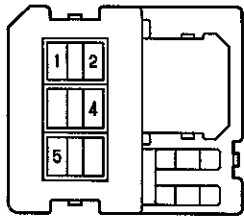

Ⓑ 茶色

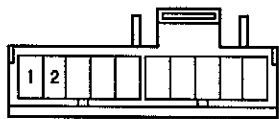

Ⓒ

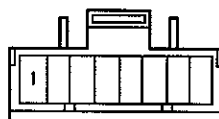

Ⓓ 灰色

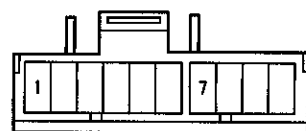

Ⓔ 青色

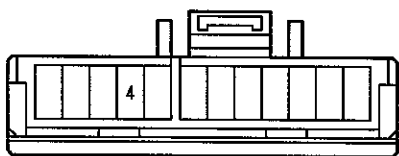

Ⓕ

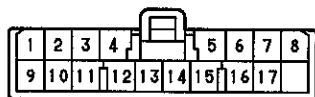

Ⓖ

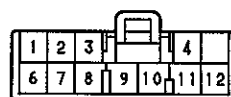

Ⓗ 黒色

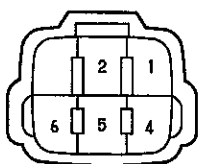

Ⓘ



Ⓙ 灰色

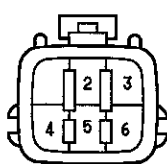

Ⓚ

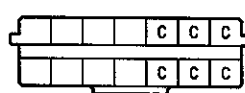

(J/B NO. 1)
(テレコ可)

Ⓛ



Ⓜ 灰色



Ⓝ



Ⓣ

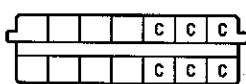

(R/B NO. 4)
(テレコ可)

Ⓟ 濃灰色

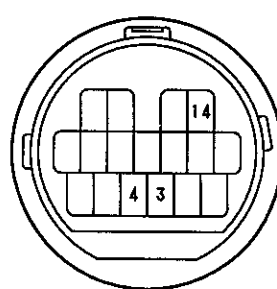

Ⓠ 濃灰色

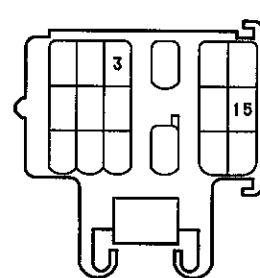

Ⓡ Ⓢ 灰色



Ⓣ 灰色



Ⓤ

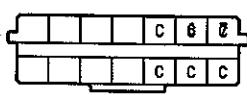

(テレコ可)

Ⓥ 黒色



ⓉⓃ

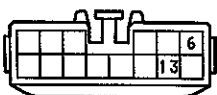

ⓉⓄ

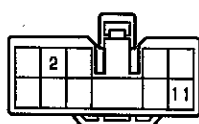

ⓉⓅ 青色

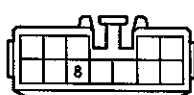

ⓉⓆ

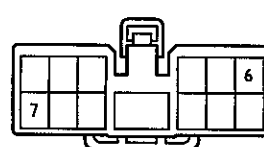



1L



3C 青色

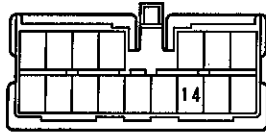

IK1

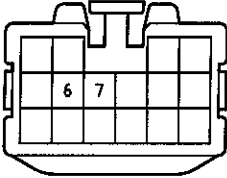

IL1

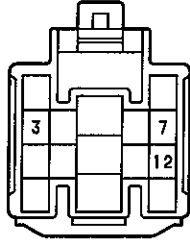

IL2

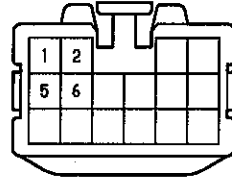

IT2 灰色

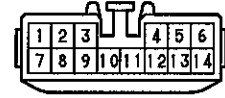

IK1

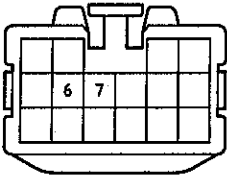

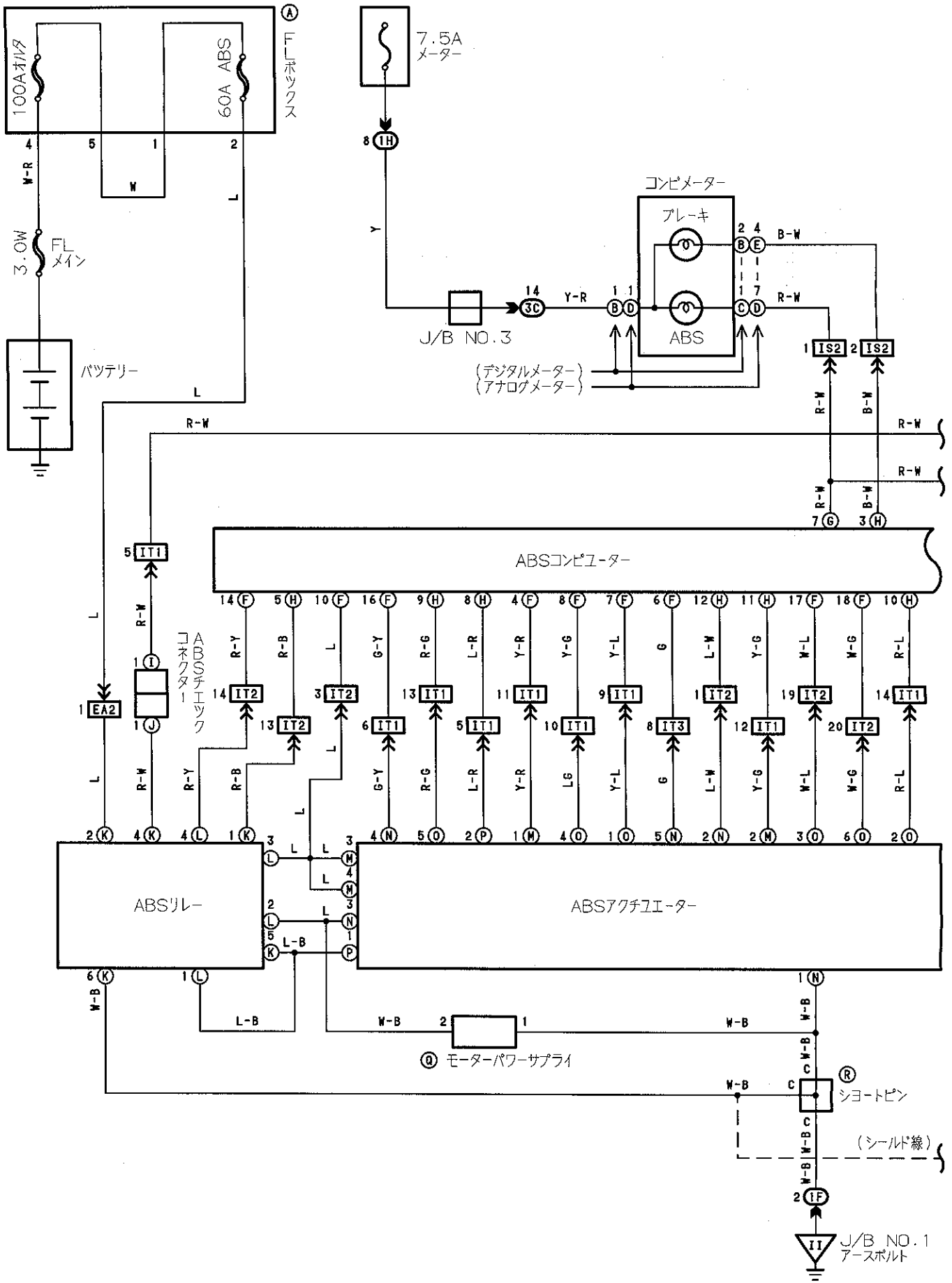

△ 1JZ-GE
 □ 1JZ-GTE

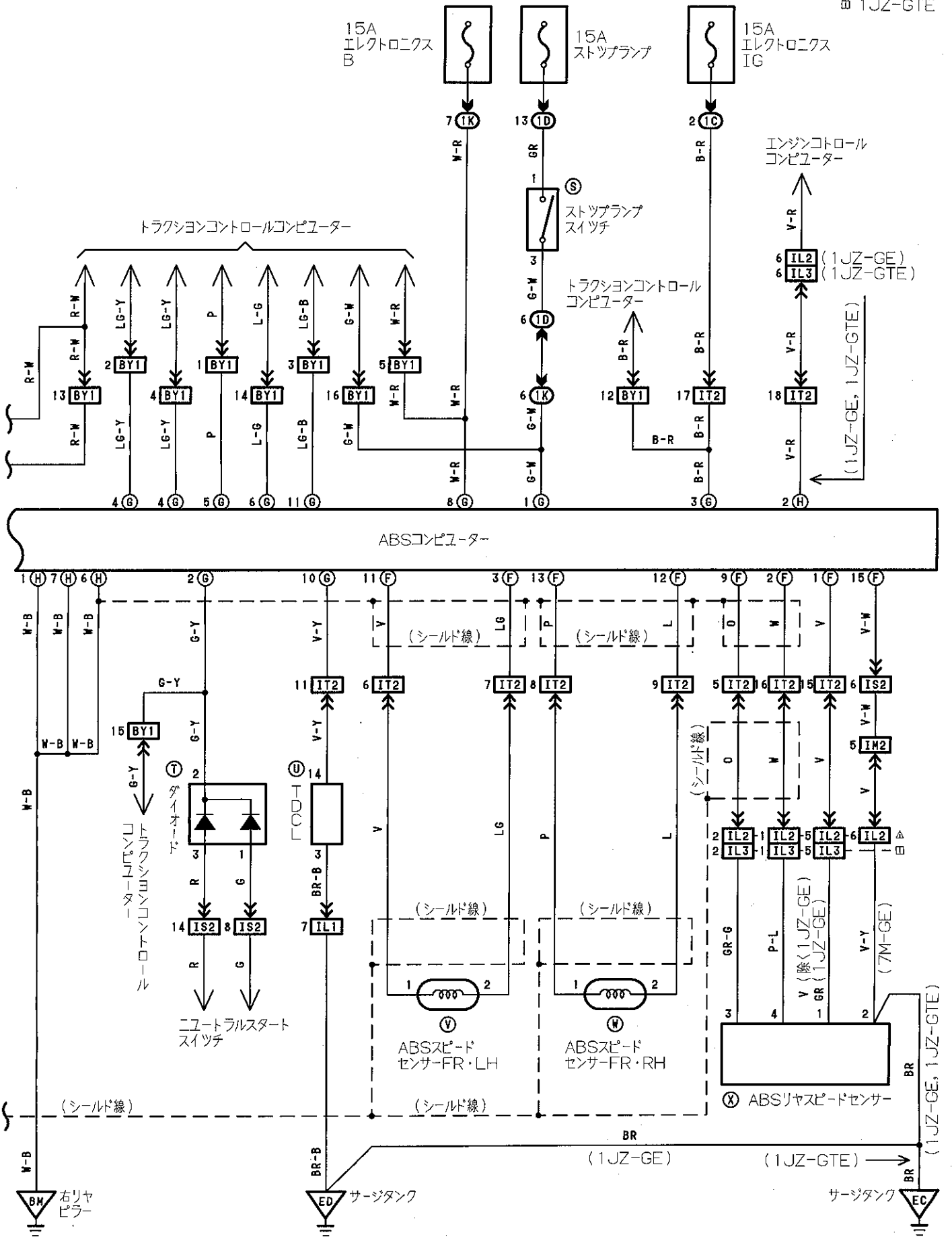

Ⓐ 黒色

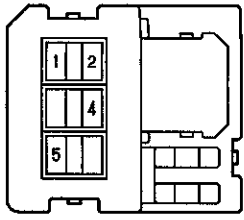

Ⓑ 茶色

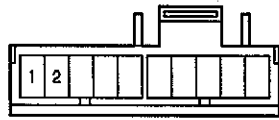

Ⓒ

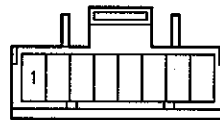

Ⓓ 灰色

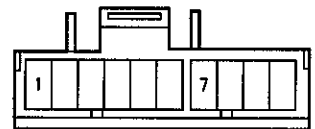

Ⓔ 青色

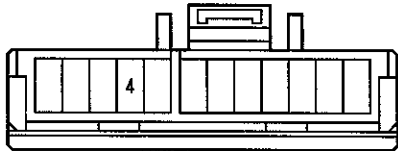

Ⓕ

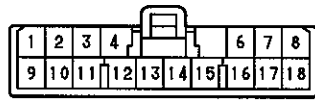

Ⓖ

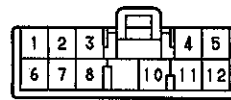

Ⓗ

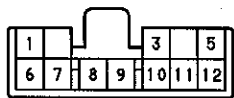

Ⓘ 灰色



Ⓙ 灰色



Ⓚ 灰色

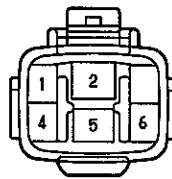

Ⓛ 灰色



Ⓜ 黒色



Ⓝ 黒色

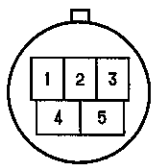

Ⓞ 黒色

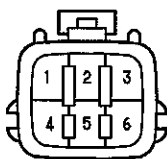

Ⓟ 黒色



Ⓠ



Ⓡ

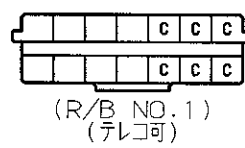

Ⓢ

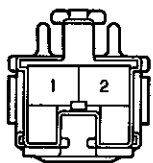

Ⓣ だいたい色

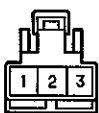

Ⓤ 濃灰色

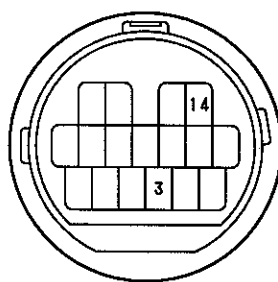

Ⓥ Ⓦ 灰色



Ⓧ 灰色



ⓁⒸ

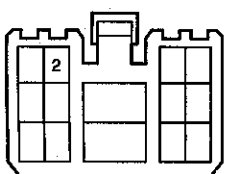

ⓁⒹ

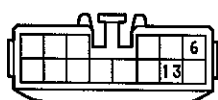

ⓁⒻ

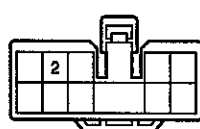

ⓁⒼ 青色

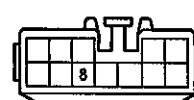

ⓁⓀ

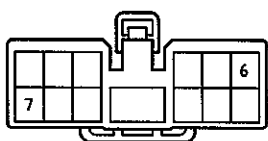

ⓁⓀ 青色

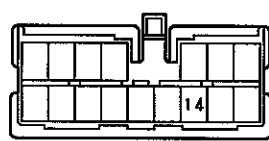



EA2 灰色

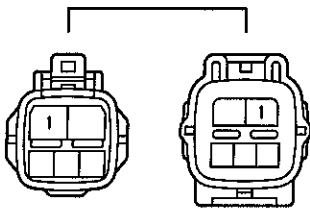

IL1 濃灰色

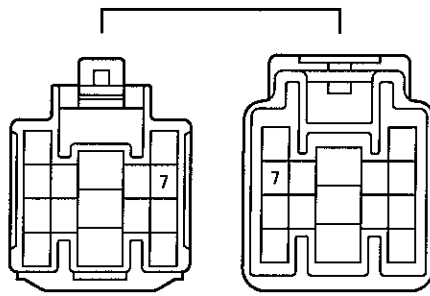

IL2 濃灰色

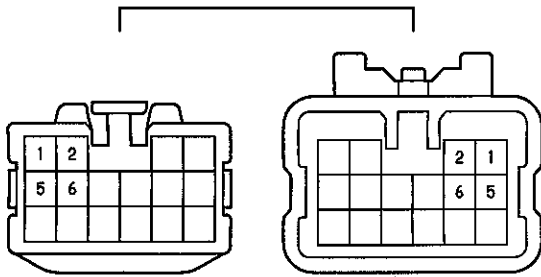

IL3 濃灰色

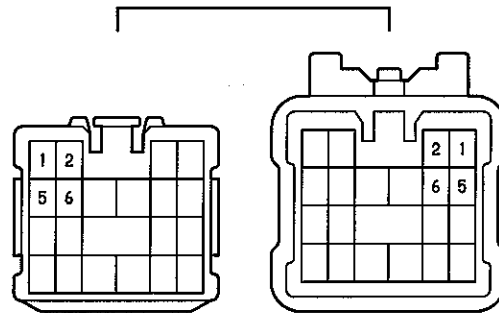

IM2

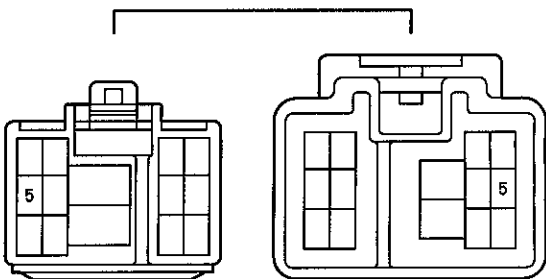

IS2 灰色

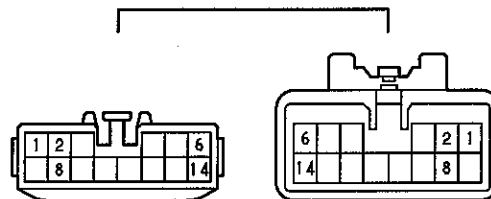

IT1 灰色

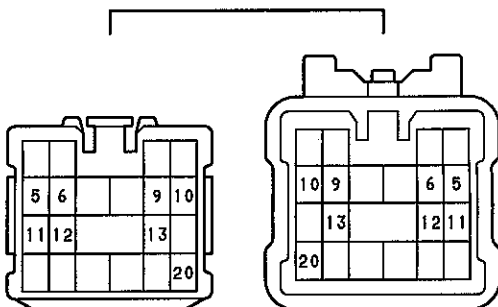

IT2

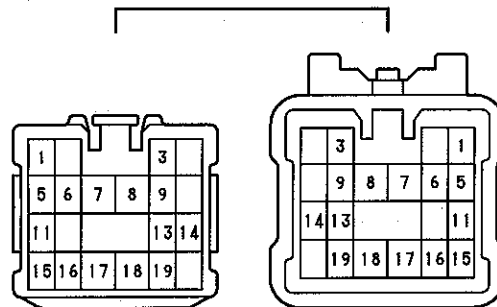

IT3

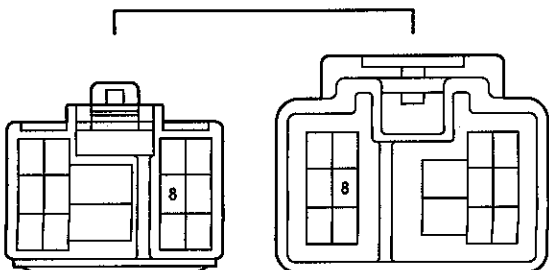

BY1 黒色

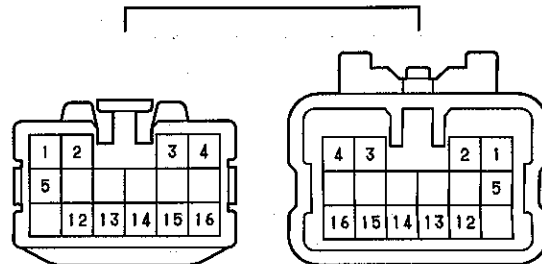

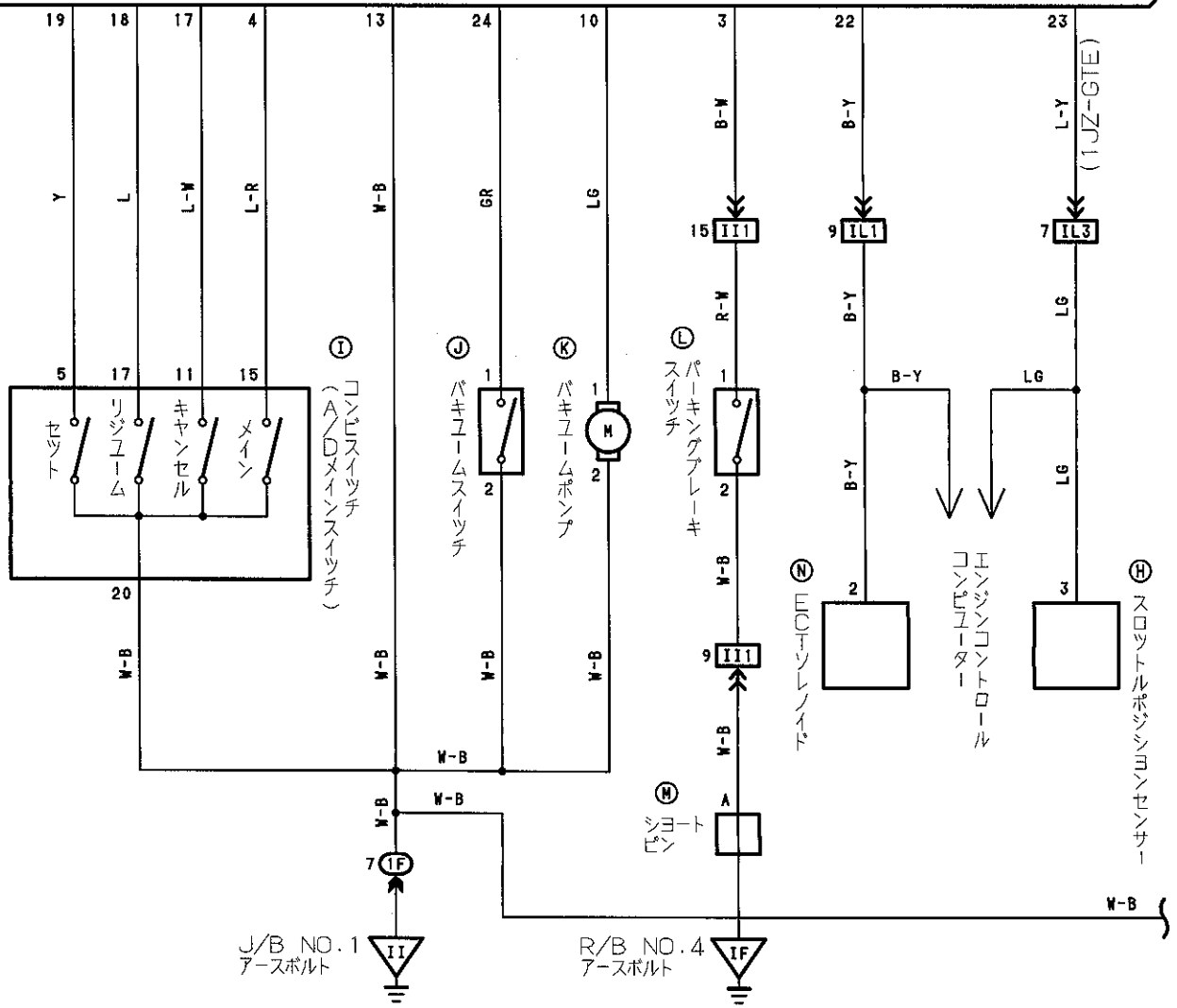
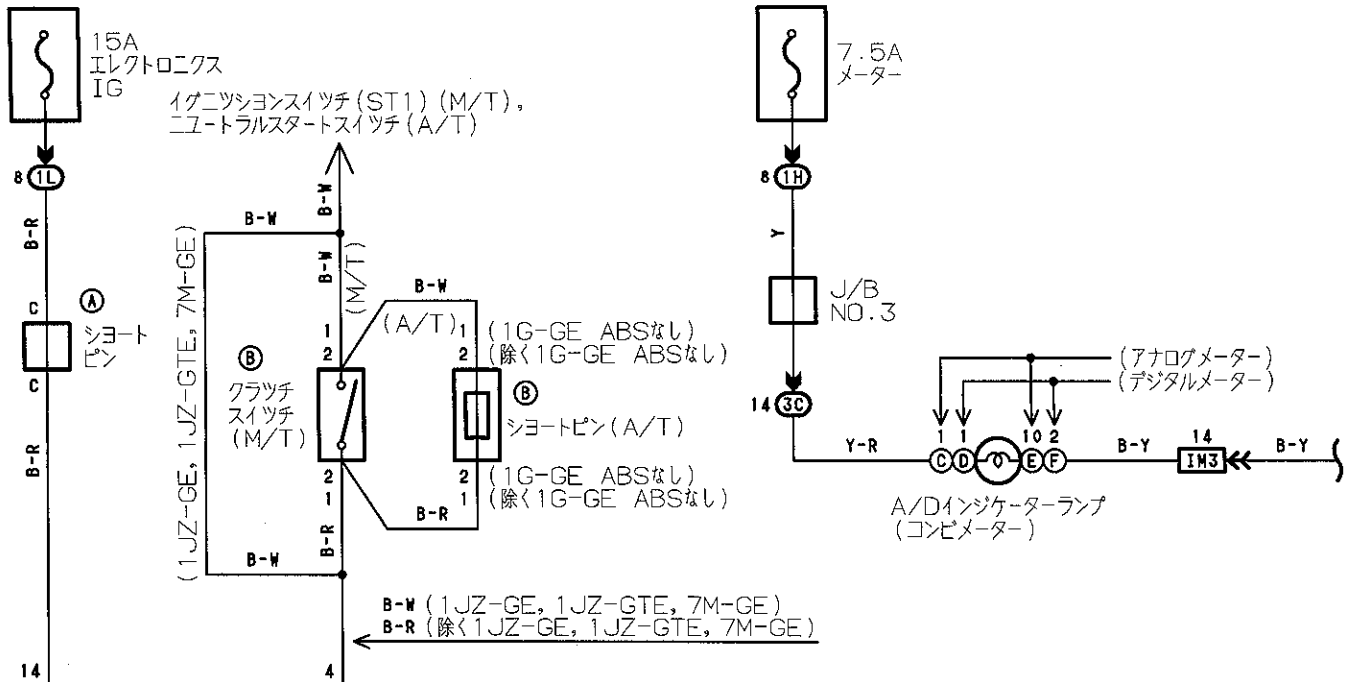

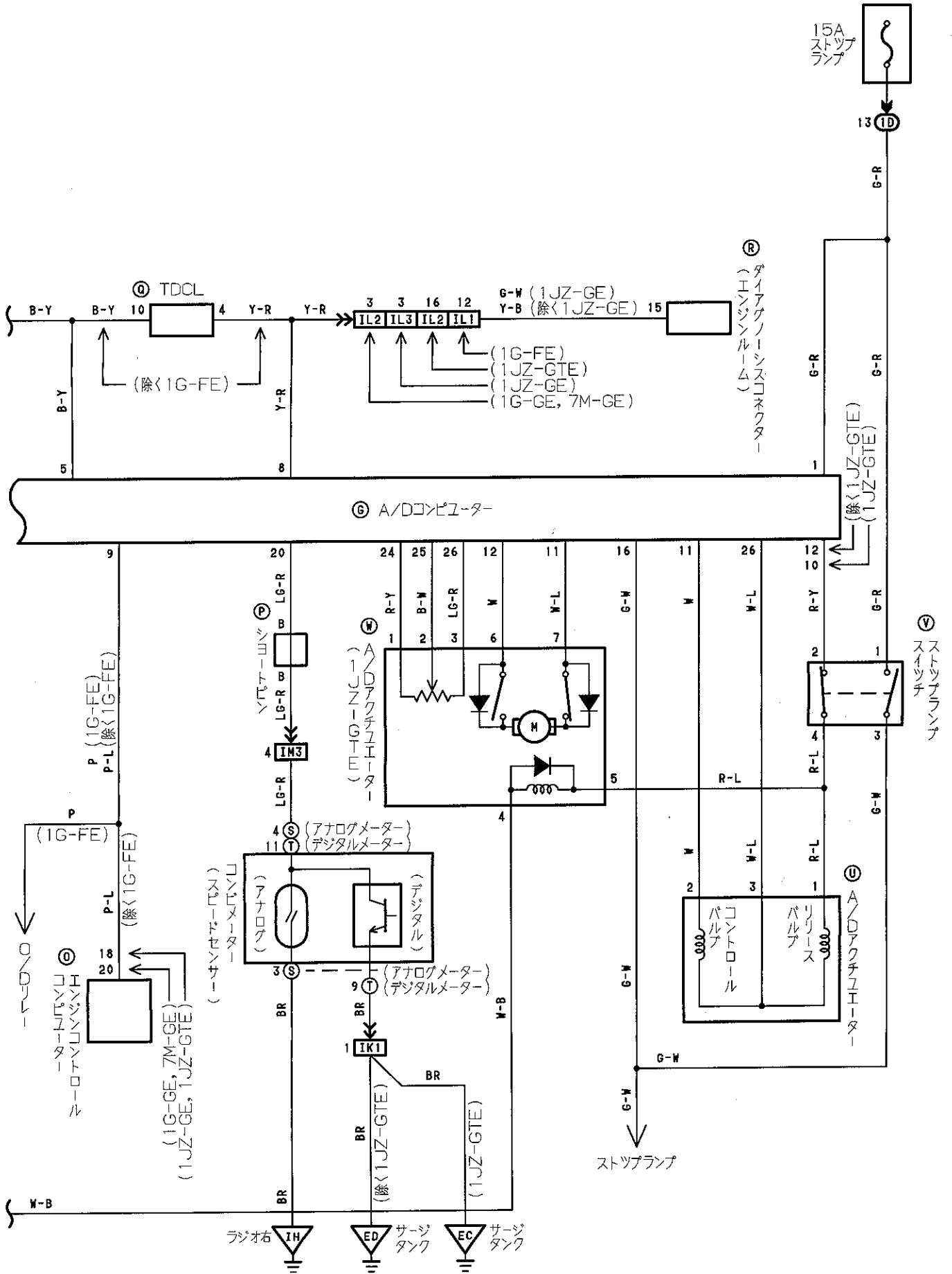

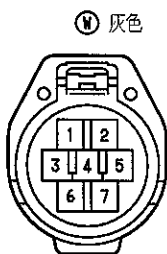
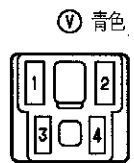
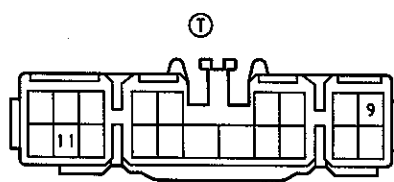
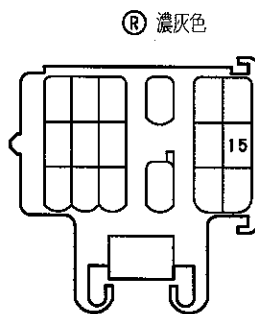
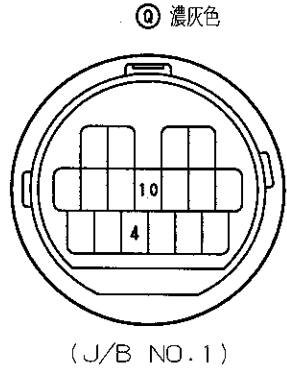
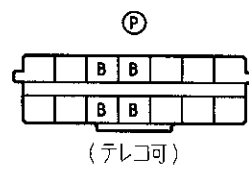
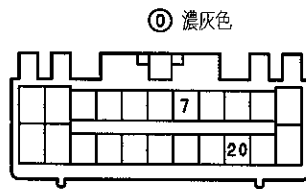
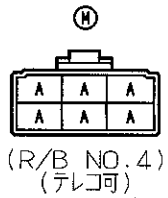
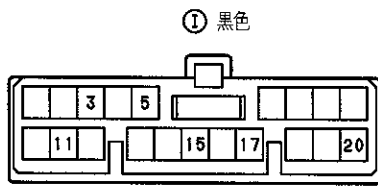
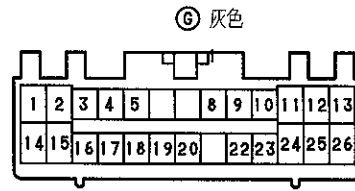
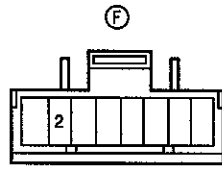
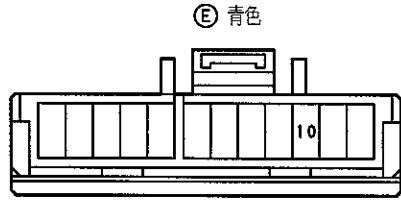
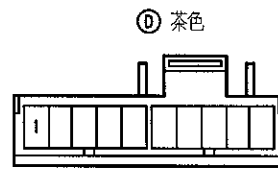
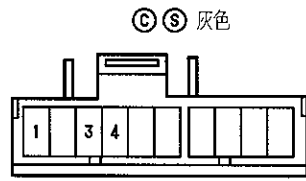
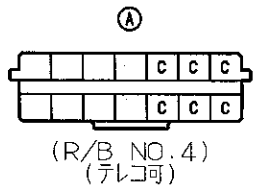

3C 青色

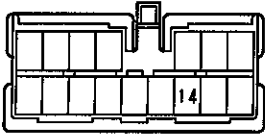

II1

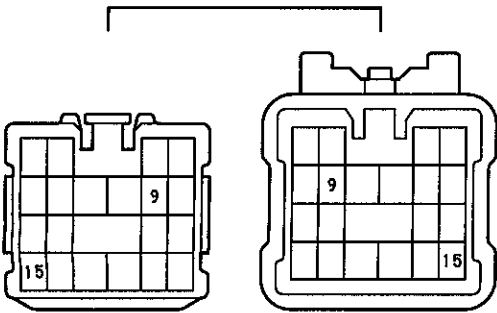

IK1 IM3

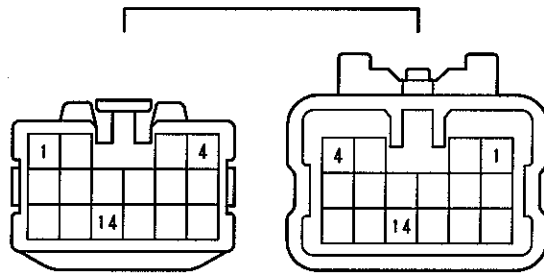

IL1 濃灰色

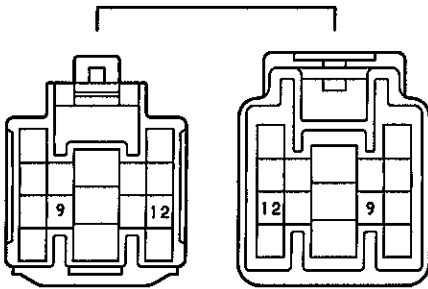

IL2 濃灰色

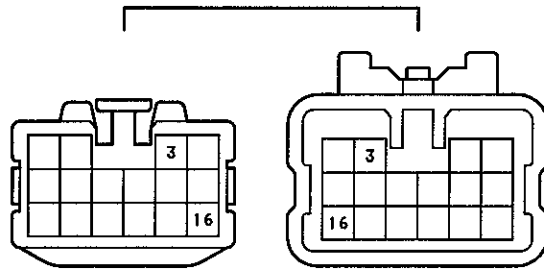

IL3 濃灰色

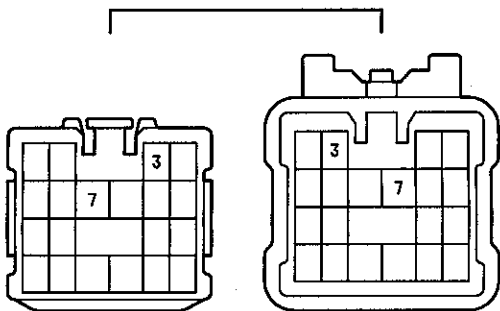

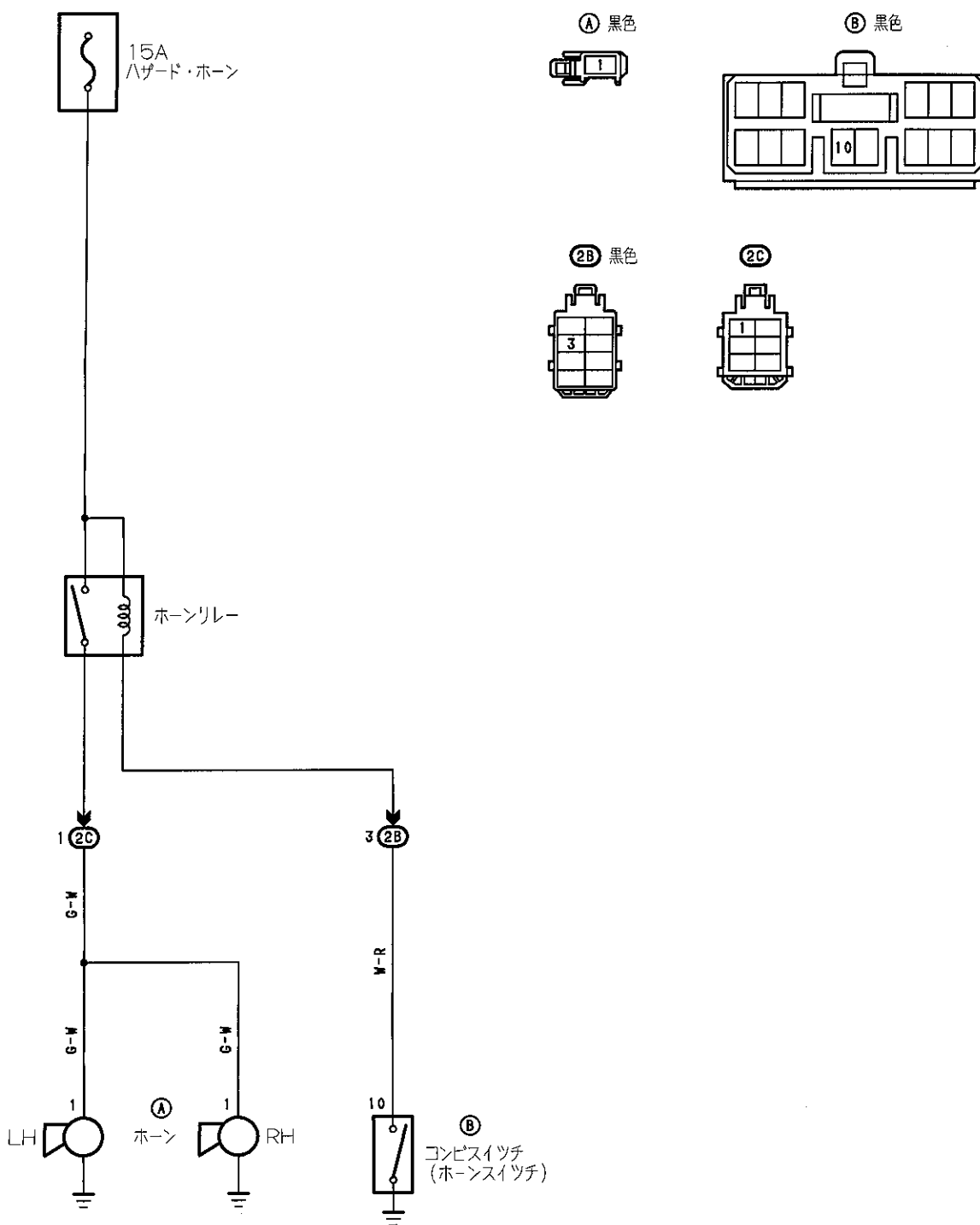



⊞ 4スピーカー
⊙ 6スピーカー

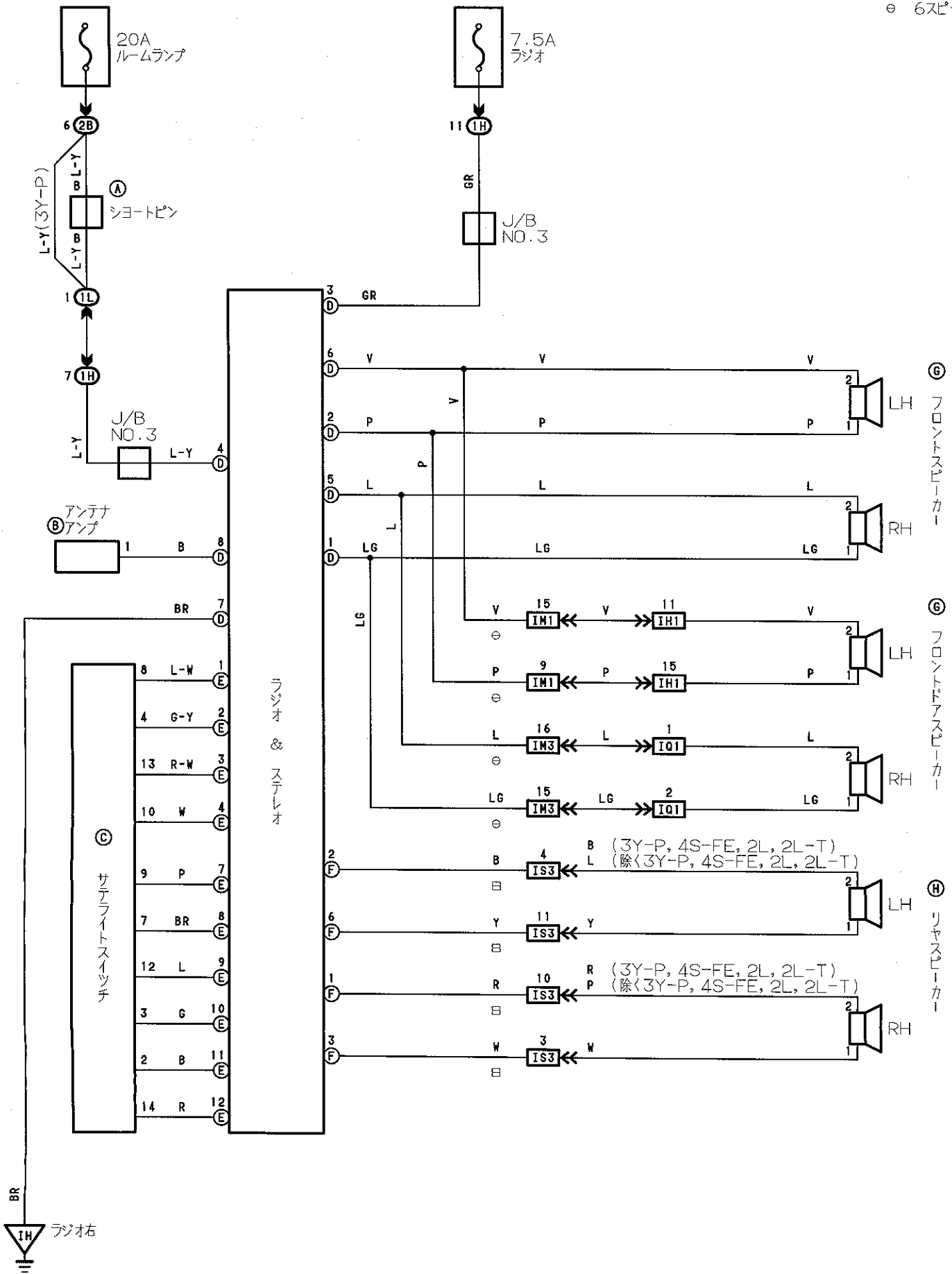

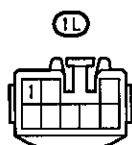
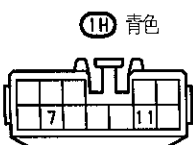
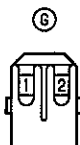
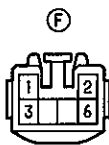
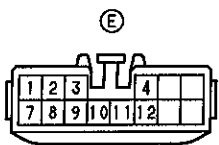
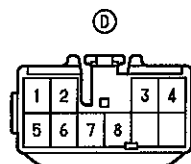
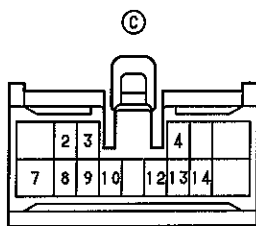
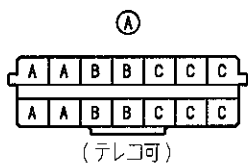

⑫ 青色

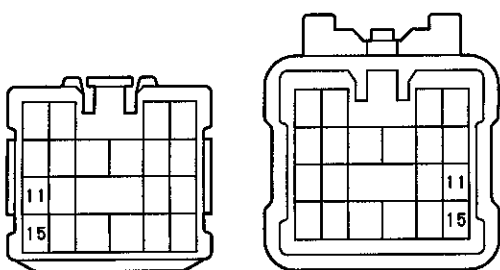

⑬ ⑭

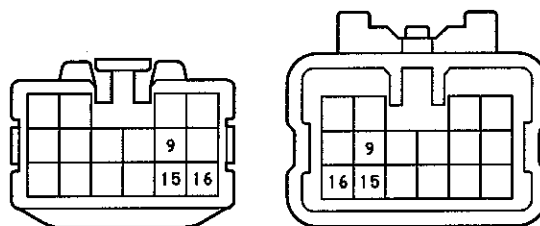

⑮ 青色

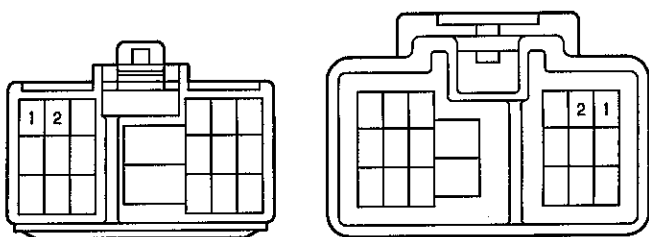

⑯ だいだい色

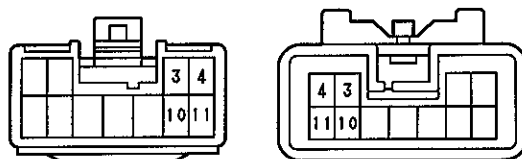

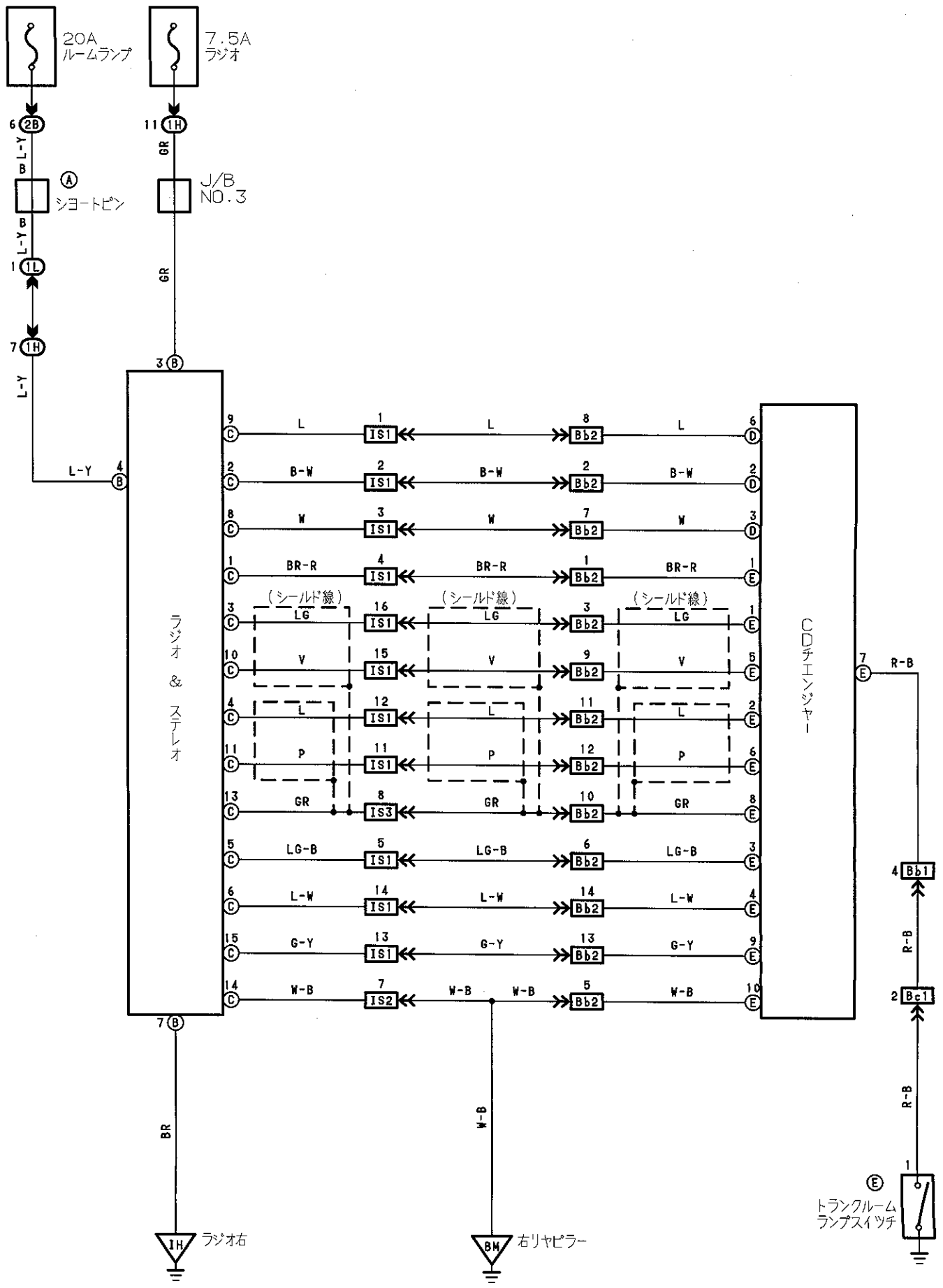

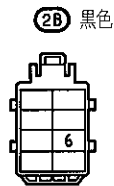
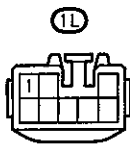
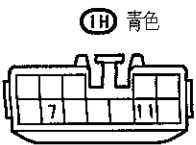
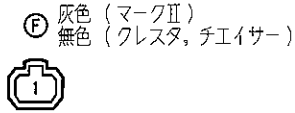
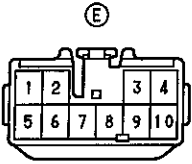
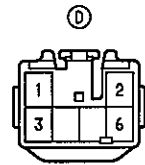
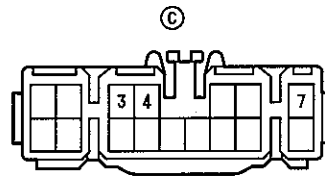
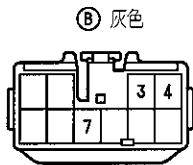
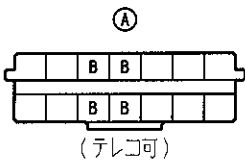

IS1 灰色

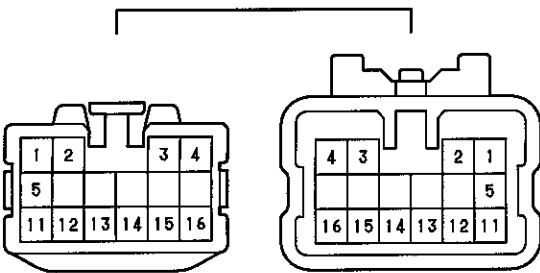

IS2 灰色

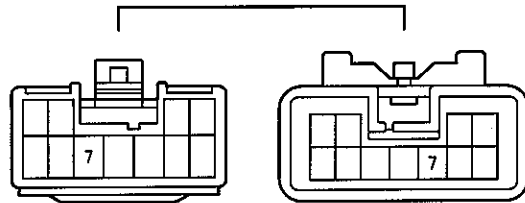

IS3 だいたい色

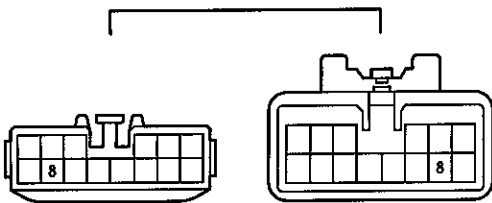

Bb1 黒色

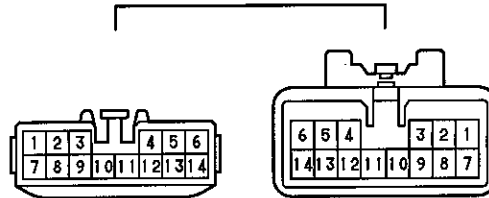

Bc1 黒色

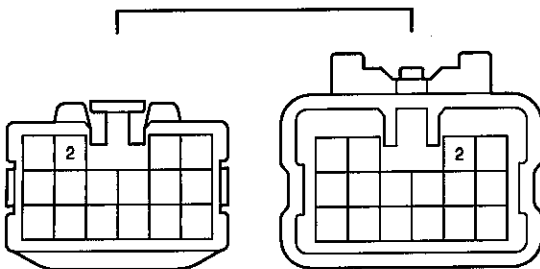

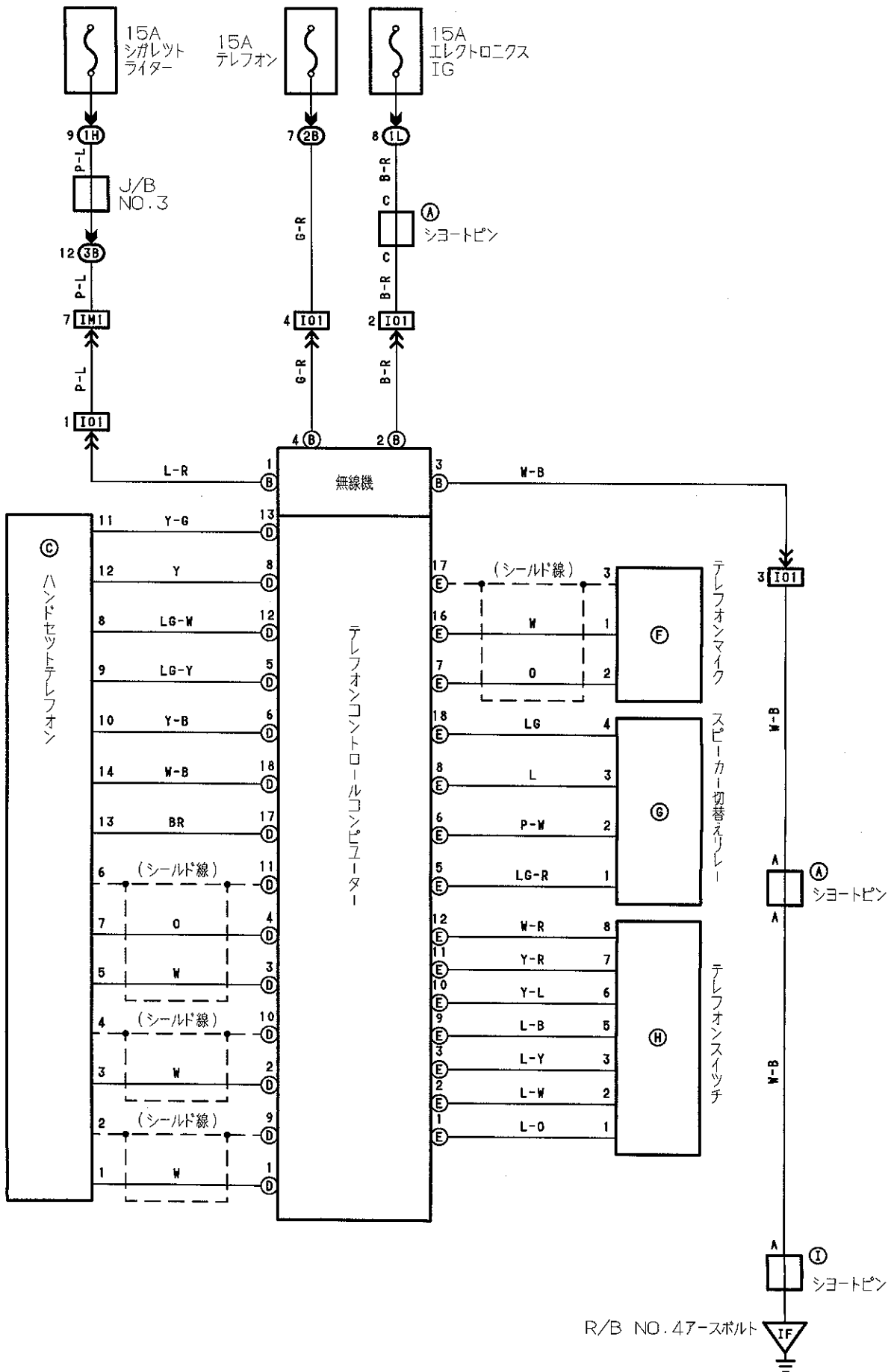

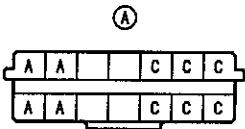

(R/B NO.4)
(テレコ可)

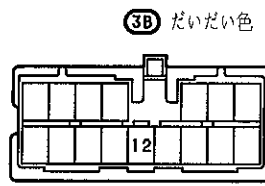
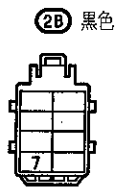
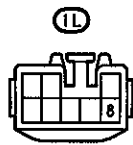
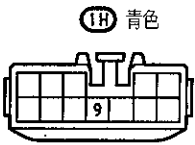
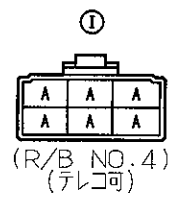
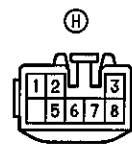
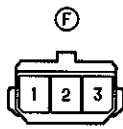
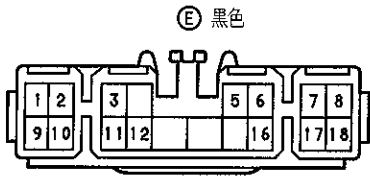
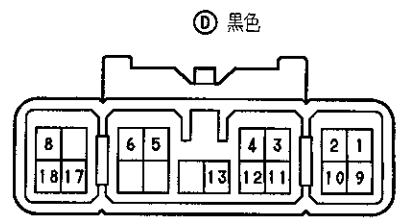
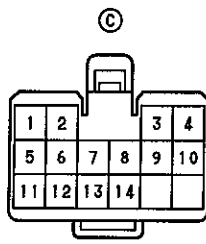

IM1

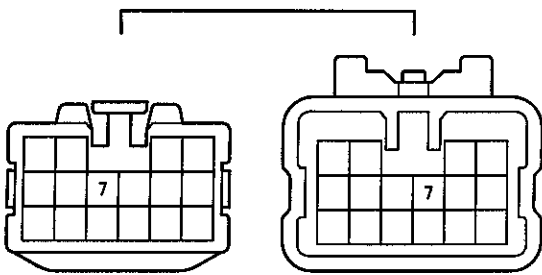

IO1

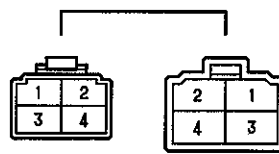



コンビネーションメーター (アナログ)

□ トラクションコントロールなし
 △ トラクションコントロール付き

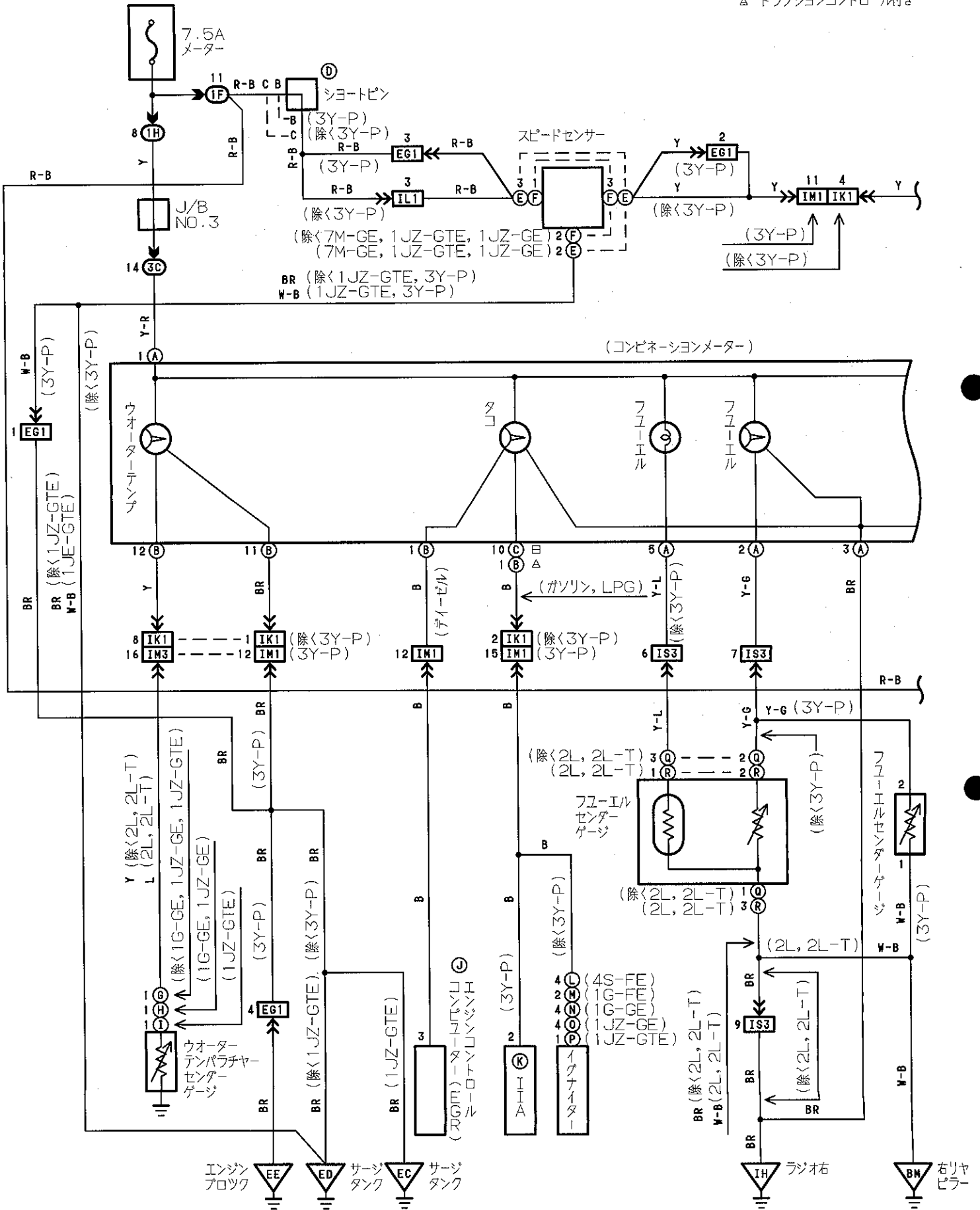



コンビネーションメーター (アナログ)

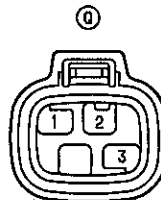
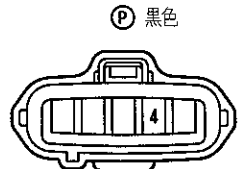
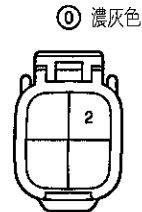
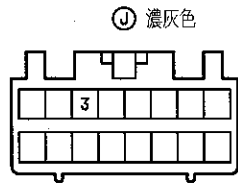
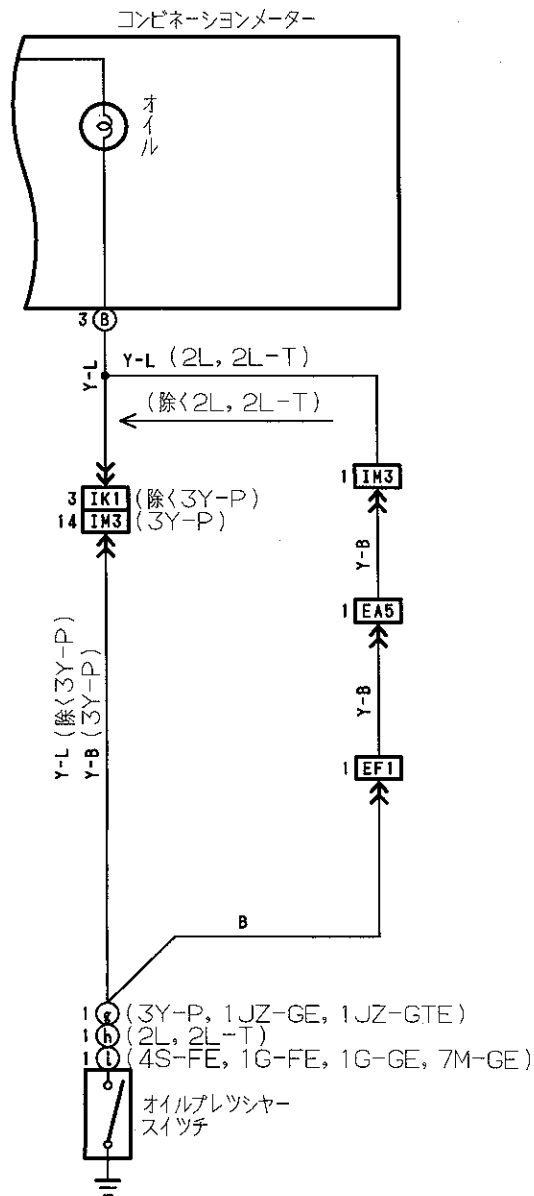
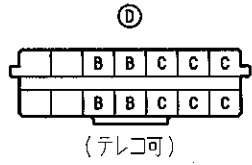
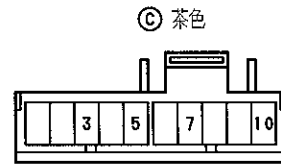
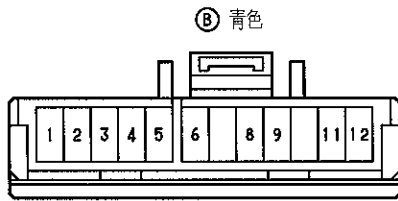
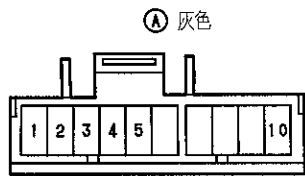

⑳ ㉑ ㉒



㉓

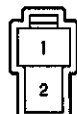

㉔

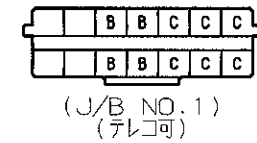

㉕ 黒色

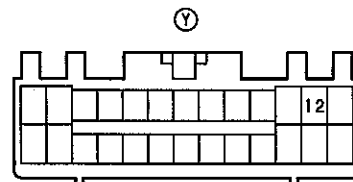
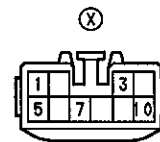

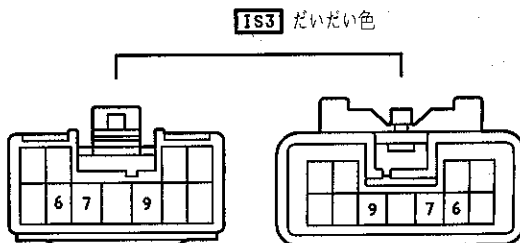
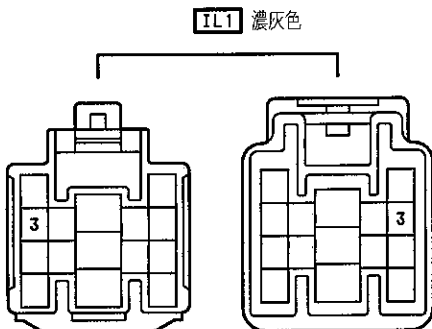
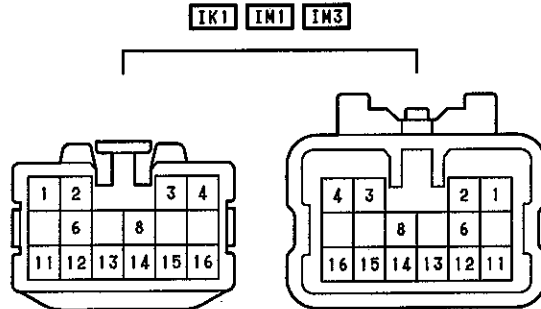
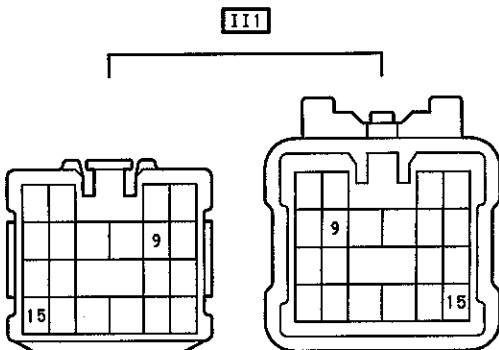
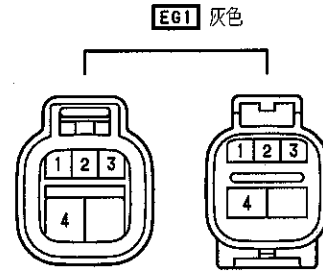
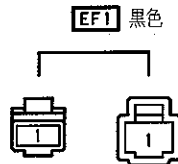
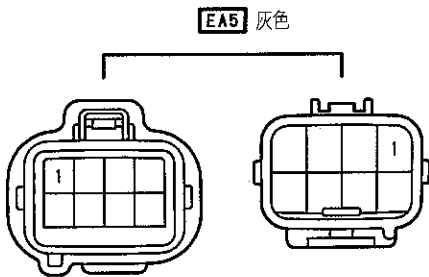
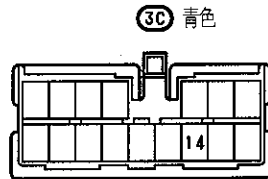
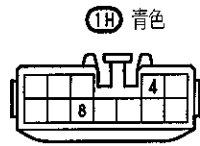
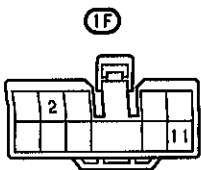
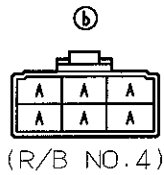
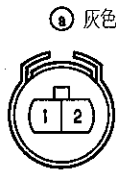
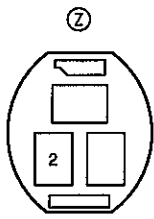

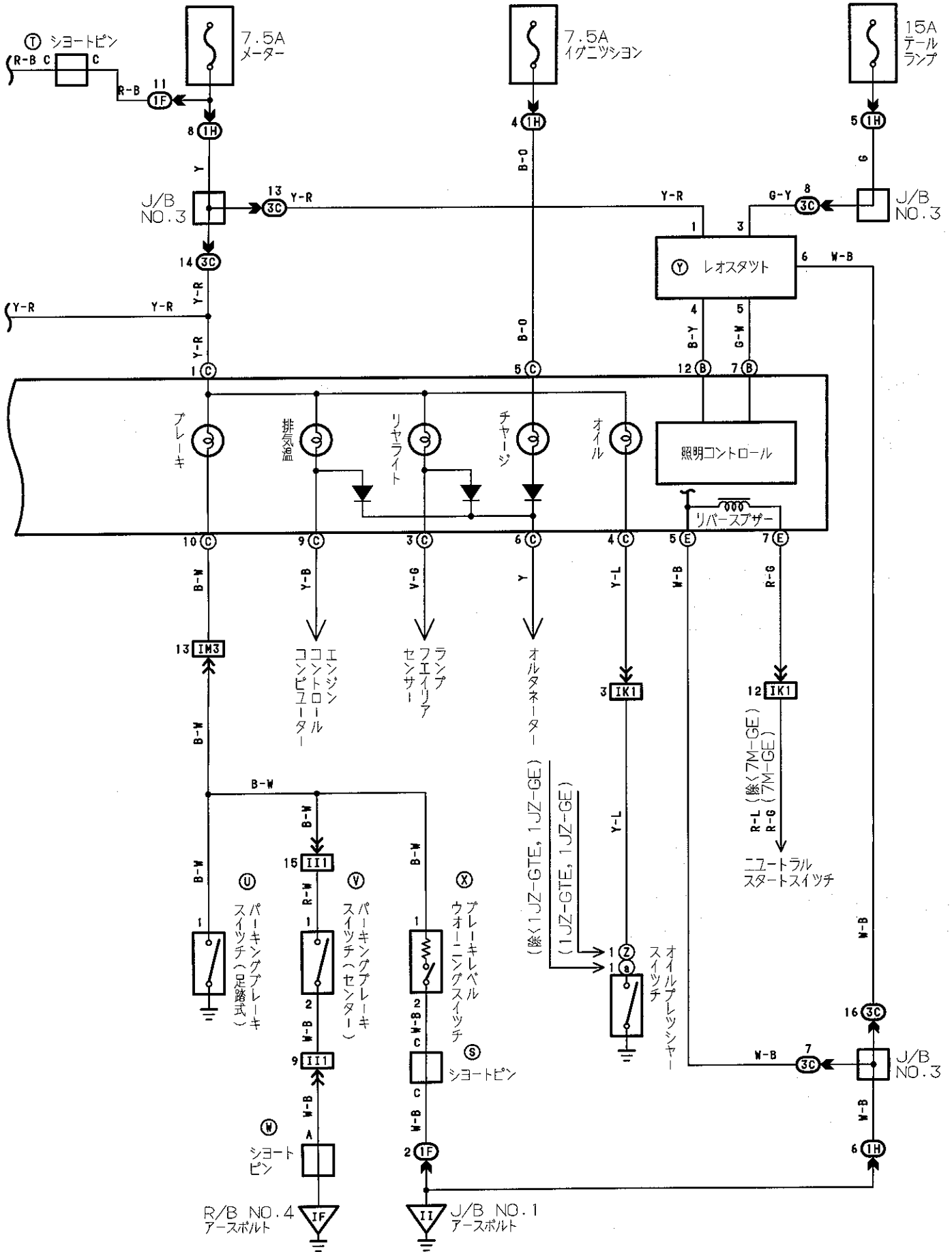

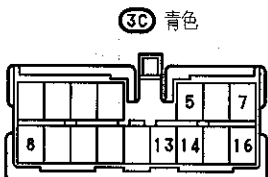
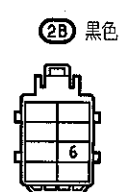
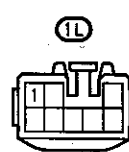
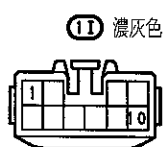
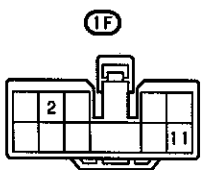
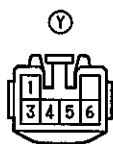
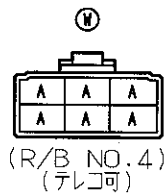
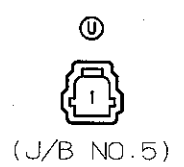
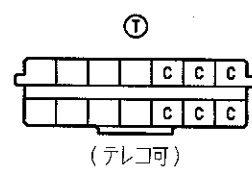
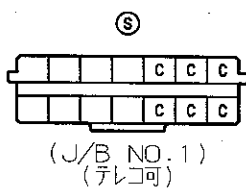
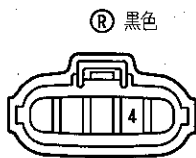
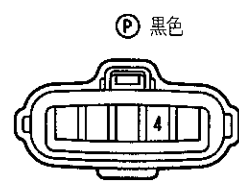
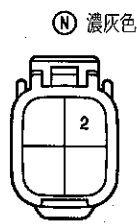
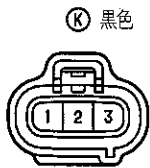
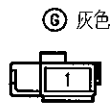
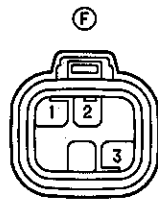
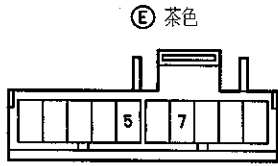
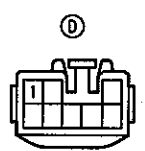
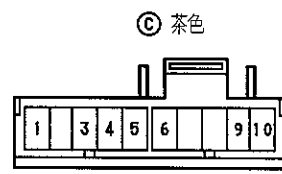
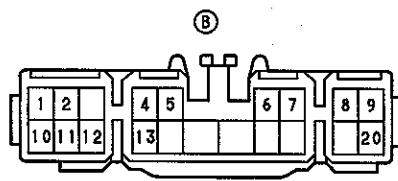
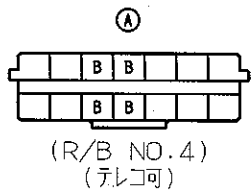



III

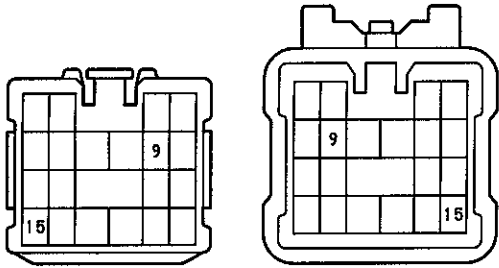

IK1

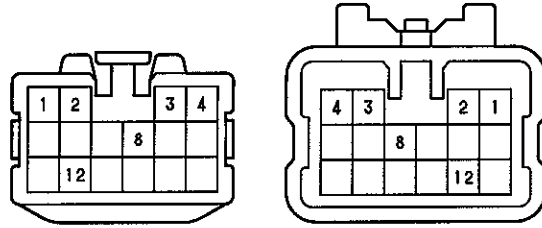

IL1 濃灰色

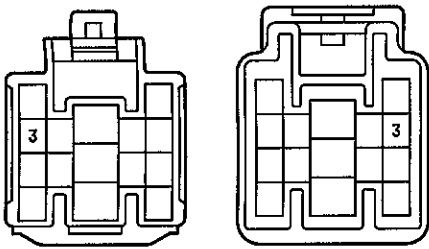

IM3

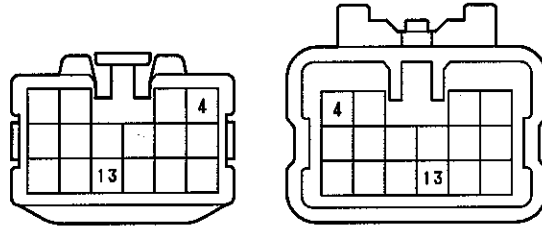

IS3 だいたい色

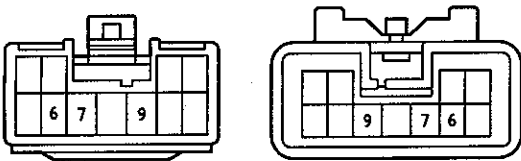

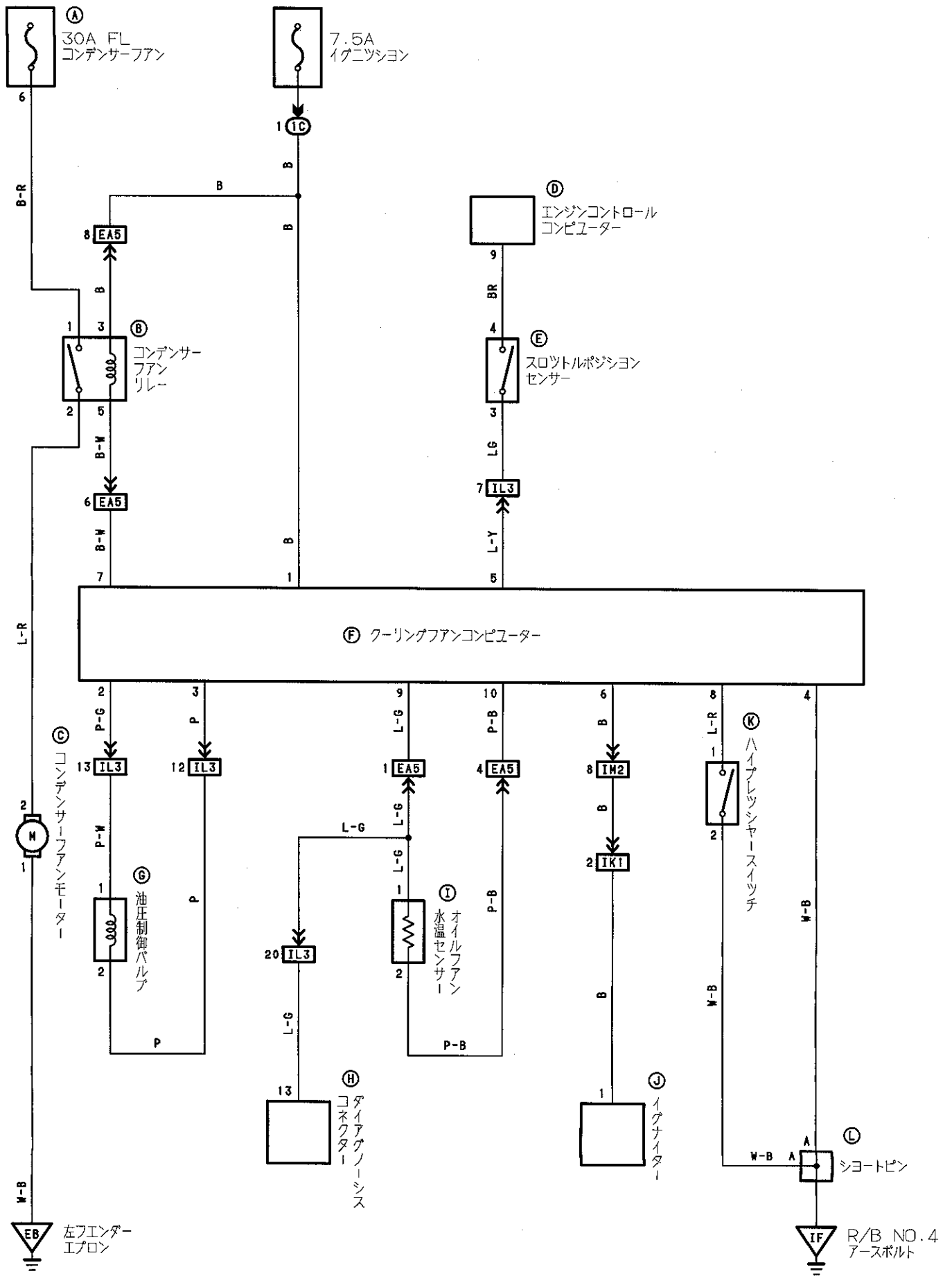



Ⓐ 黒色

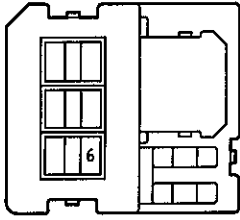

Ⓑ 灰色

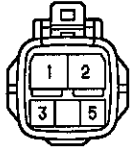

Ⓒ 黒色



Ⓓ 濃灰色

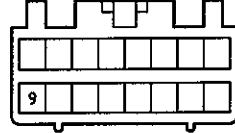

Ⓔ 黒色



Ⓕ 濃灰色



Ⓖ 灰色



Ⓗ 濃灰色

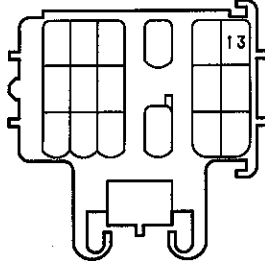

Ⓘ 茶色



Ⓙ 黒色



Ⓚ 黒色



Ⓛ



(R/B NO. 4)
(テレコ可)

Ⓛc

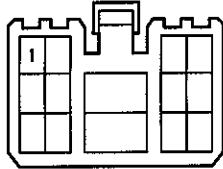

EA5 灰色

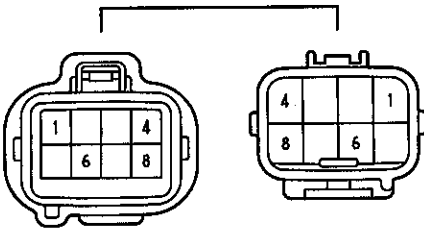

IK1

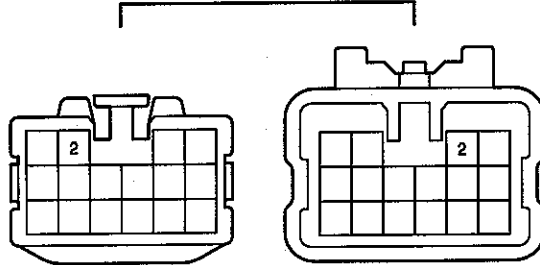

IL3 濃灰色

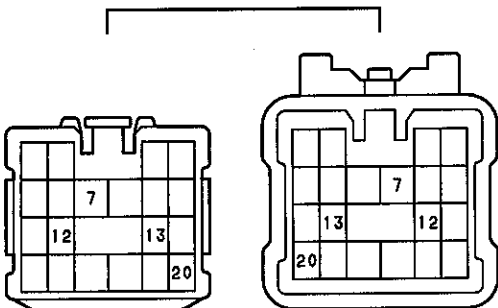

IM2

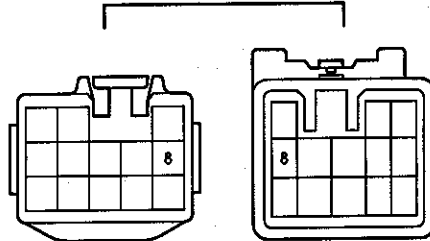

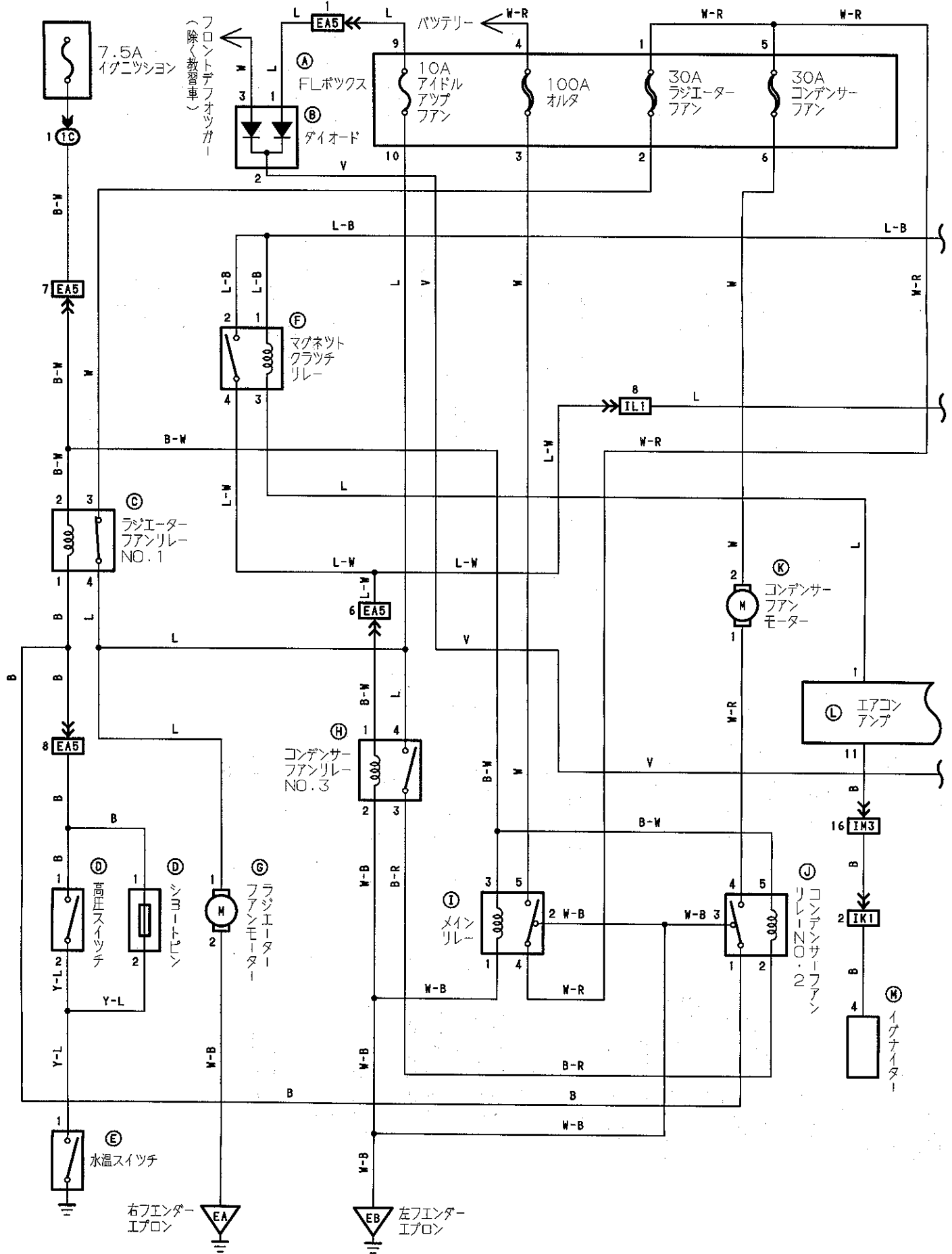

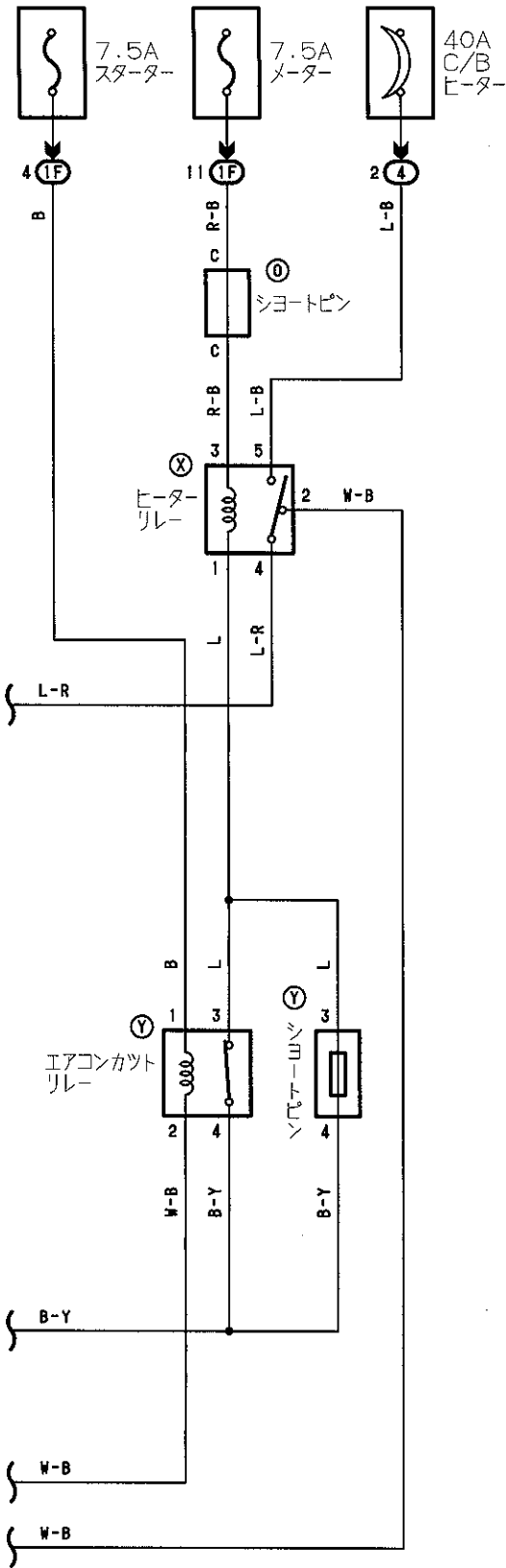

- ① ② ③ ④ ⑤ ⑥ ⑦ ⑧ ⑨ ⑩
 - ⑪ ⑫ ⑬ ⑭ ⑮ ⑯ ⑰ ⑱ ⑲ ⑳
 - ㉑ ㉒ ㉓ ㉔ ㉕ ㉖ ㉗ ㉘ ㉙ ㉚
 - ㉛ ㉜ ㉝ ㉞ ㉟ ㊱ ㊲ ㊳ ㊴ ㊵
 - ㊶ ㊷ ㊸ ㊹ ㊺ ㊻ ㊼ ㊽ ㊾ ㊿
- (R/B NO.6) (R/B NO.6) (R/B NO.6)
- (R/B NO.4) (R/B NO.4)

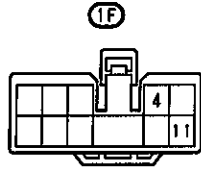
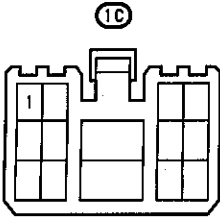
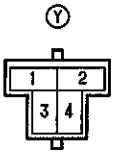

EA5 灰色

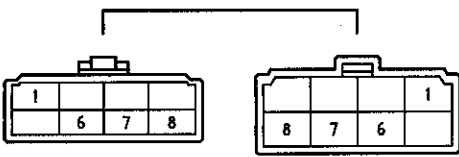

IL1 濃灰色

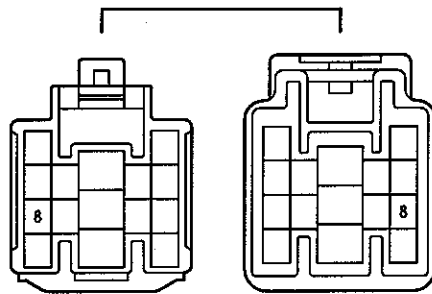

IL2 濃灰色

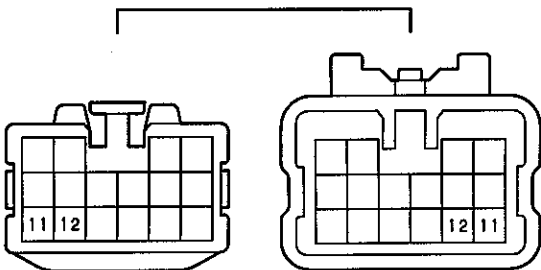

IK1 IM3

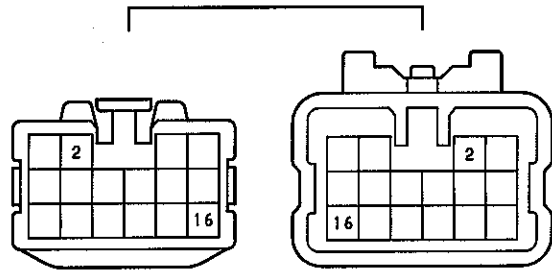

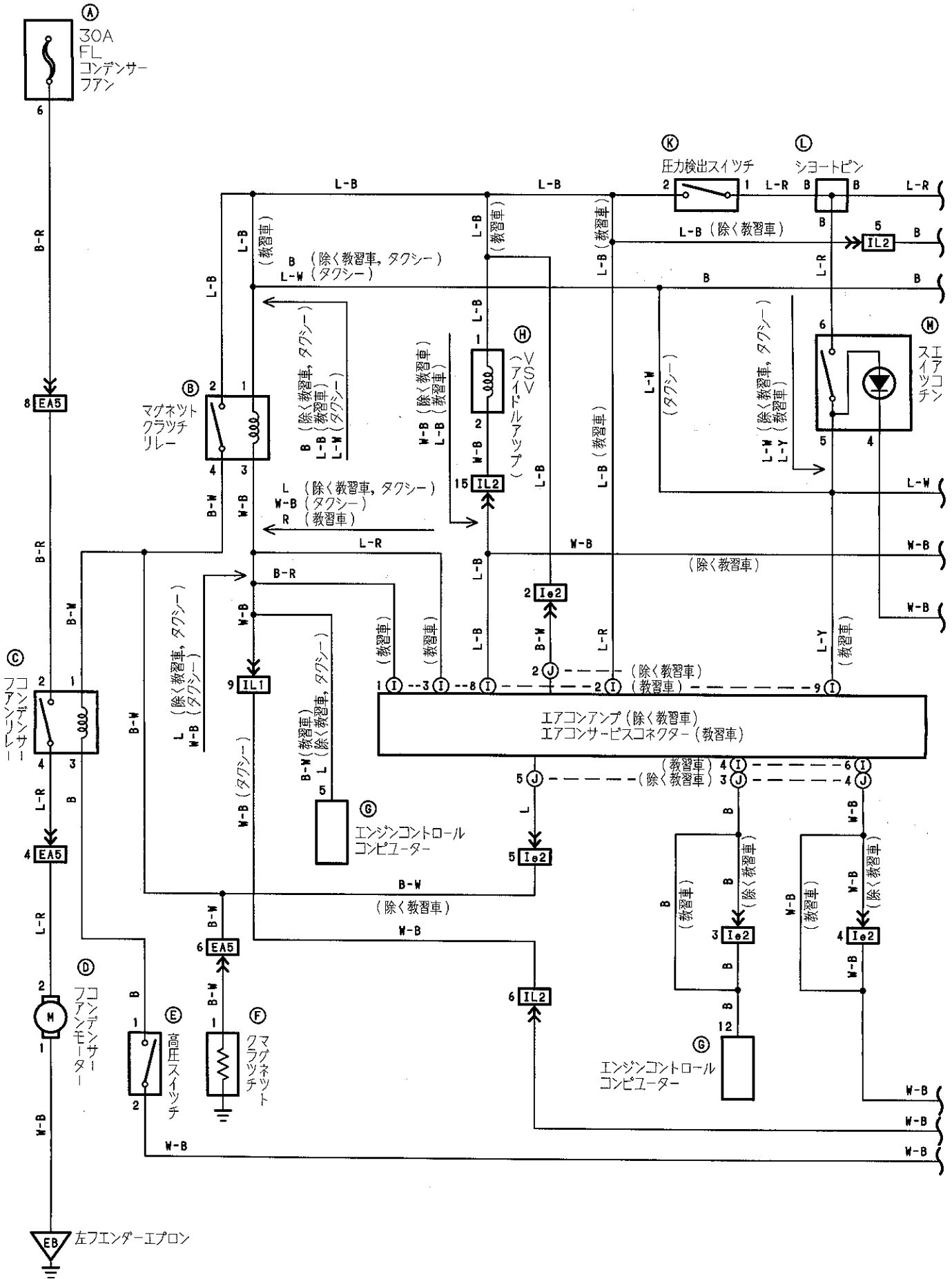

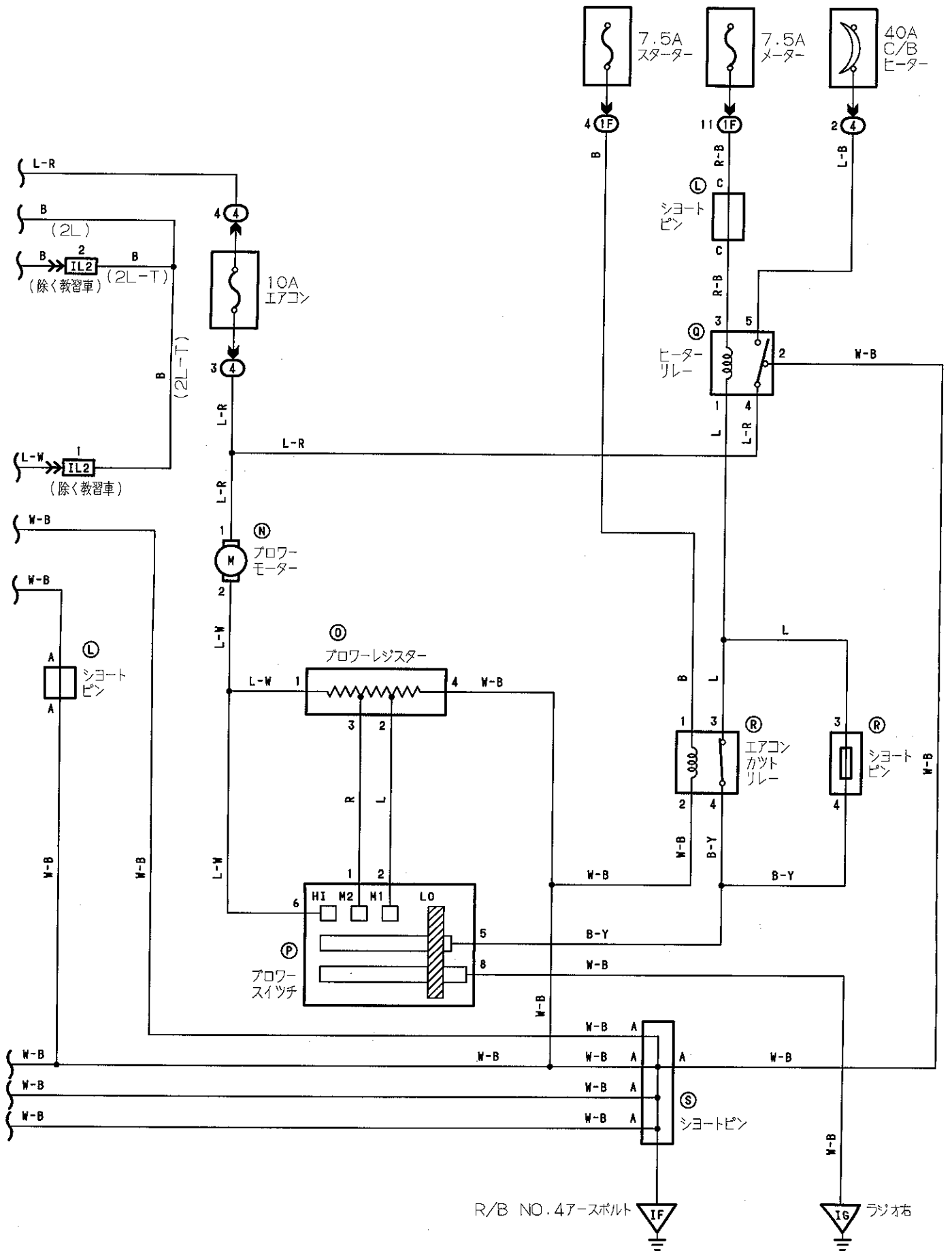

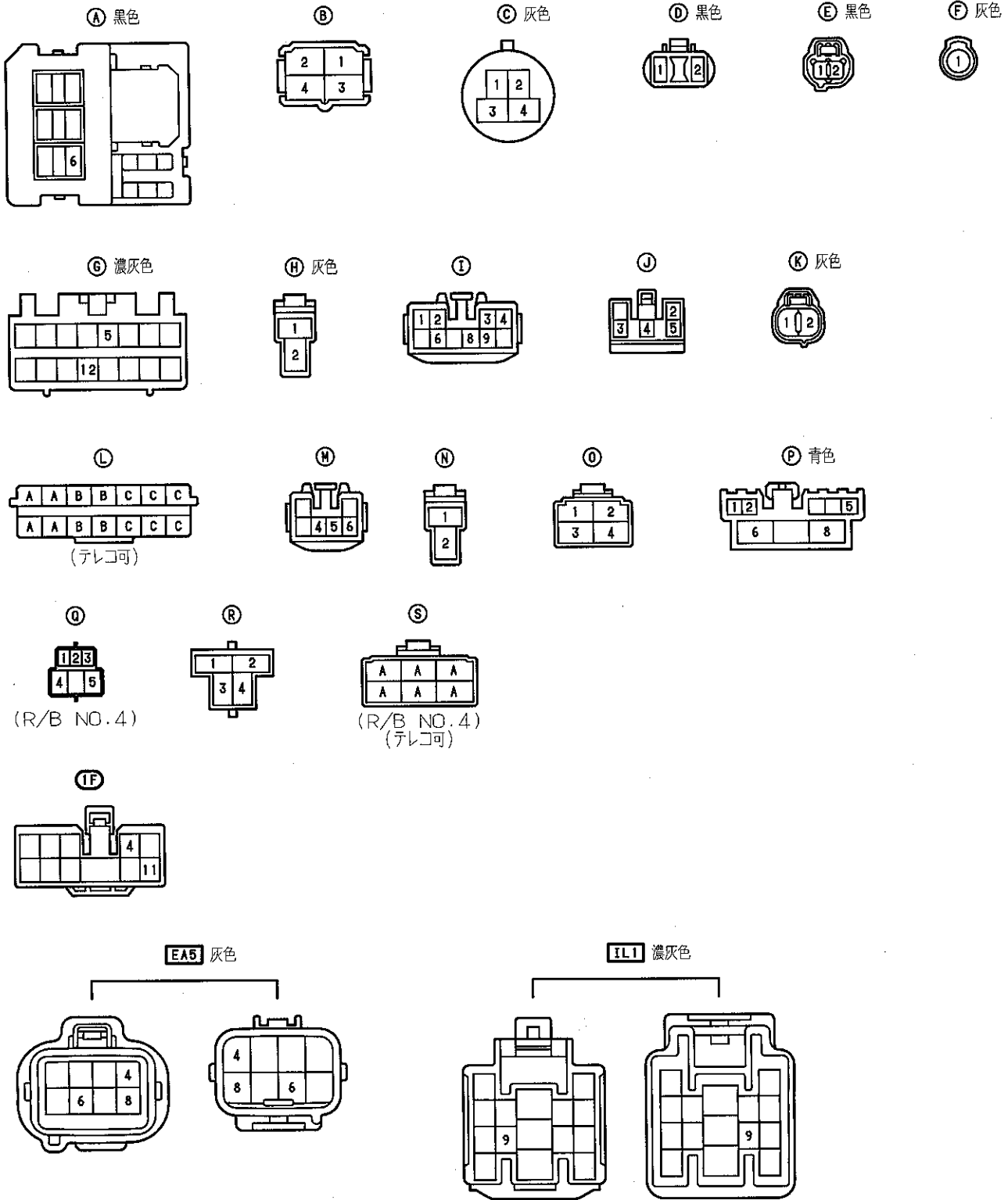



IL2 濃灰色

Ie2

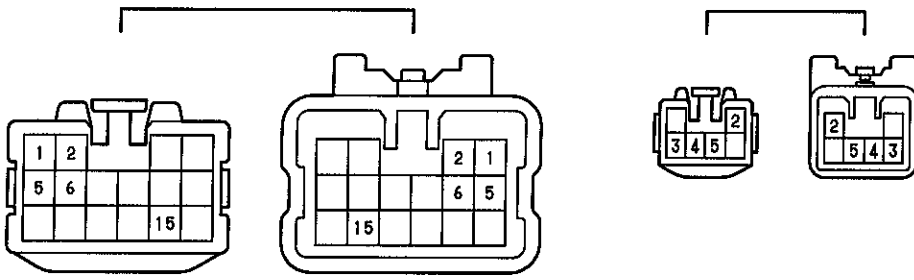

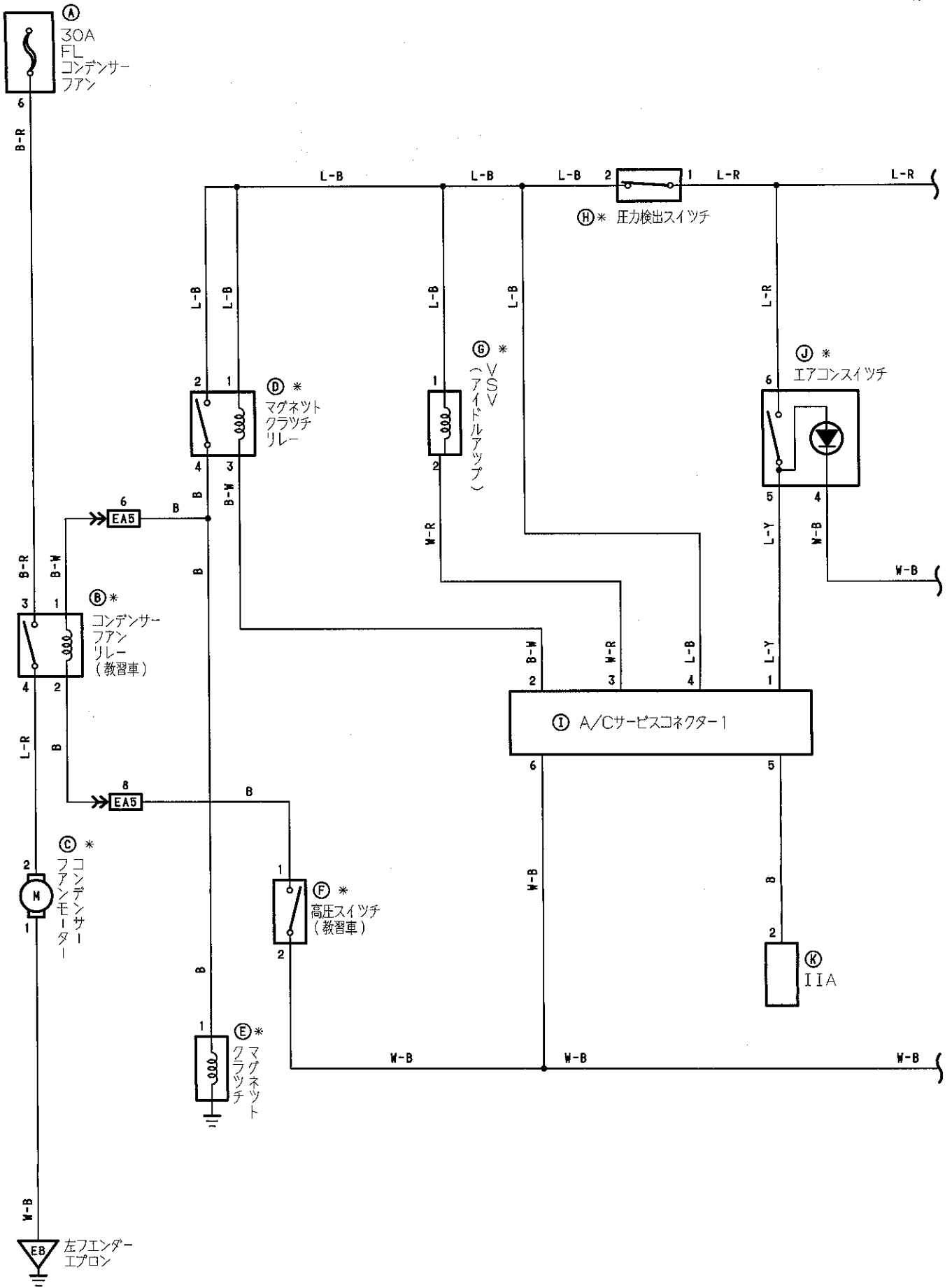

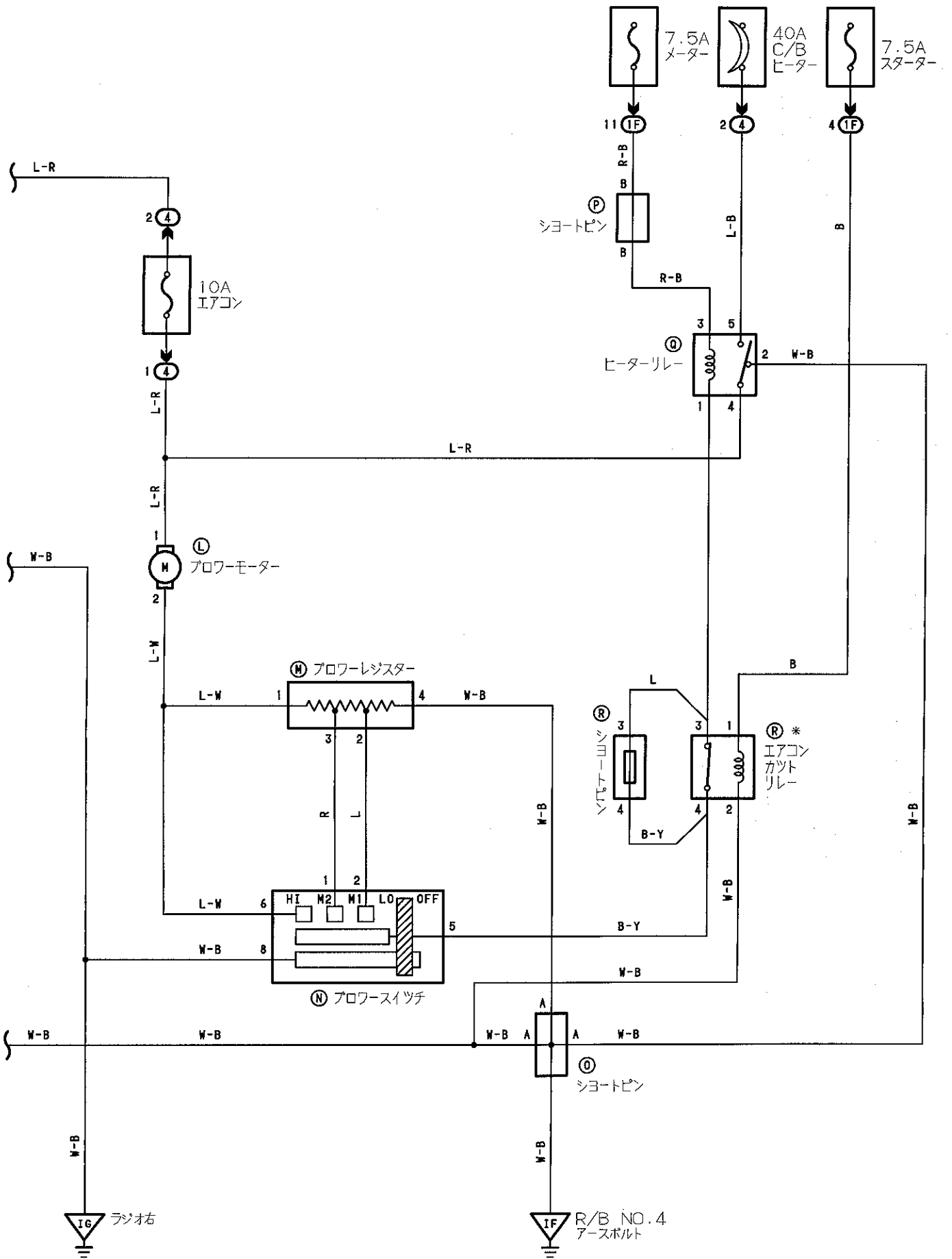

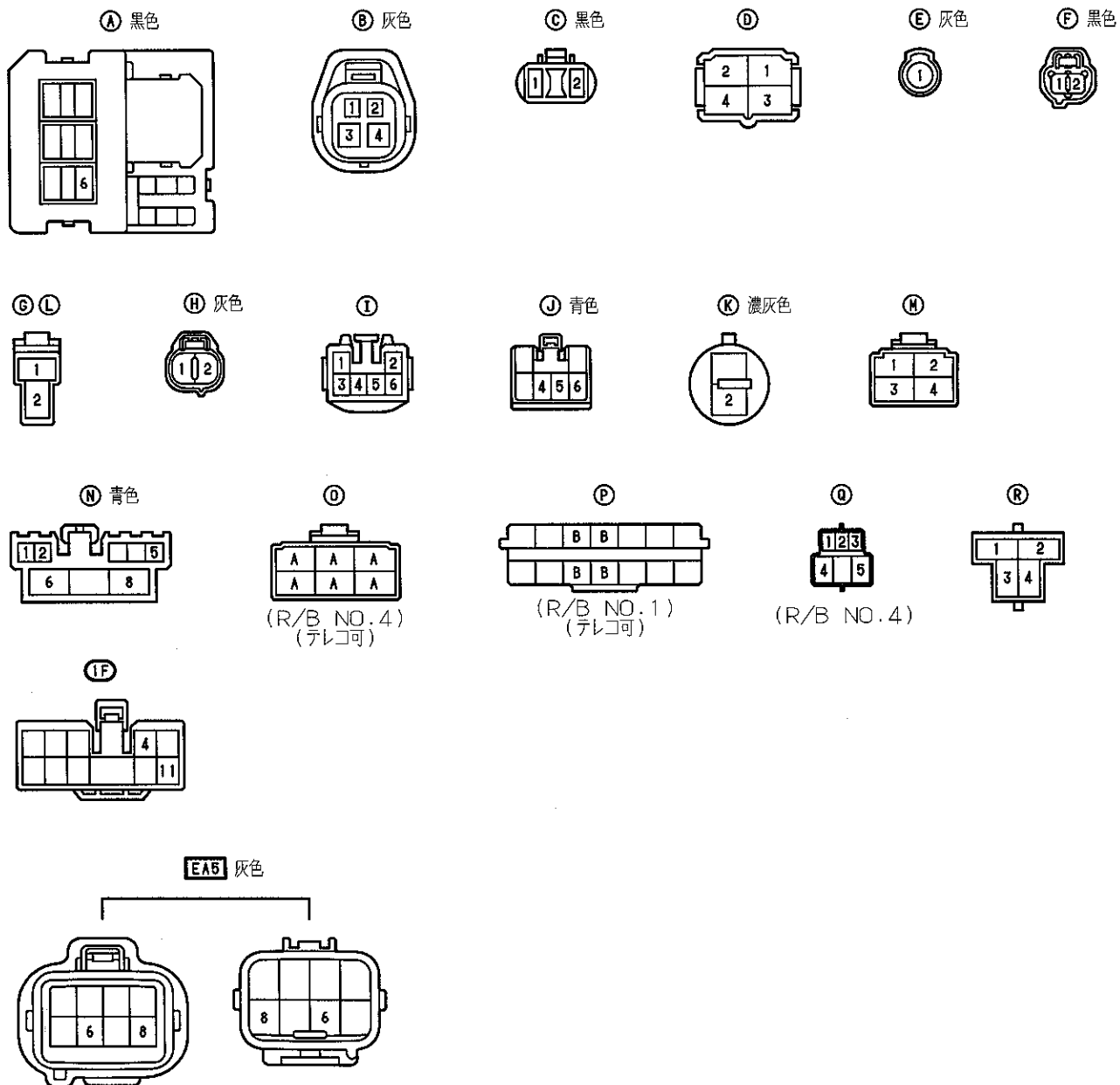

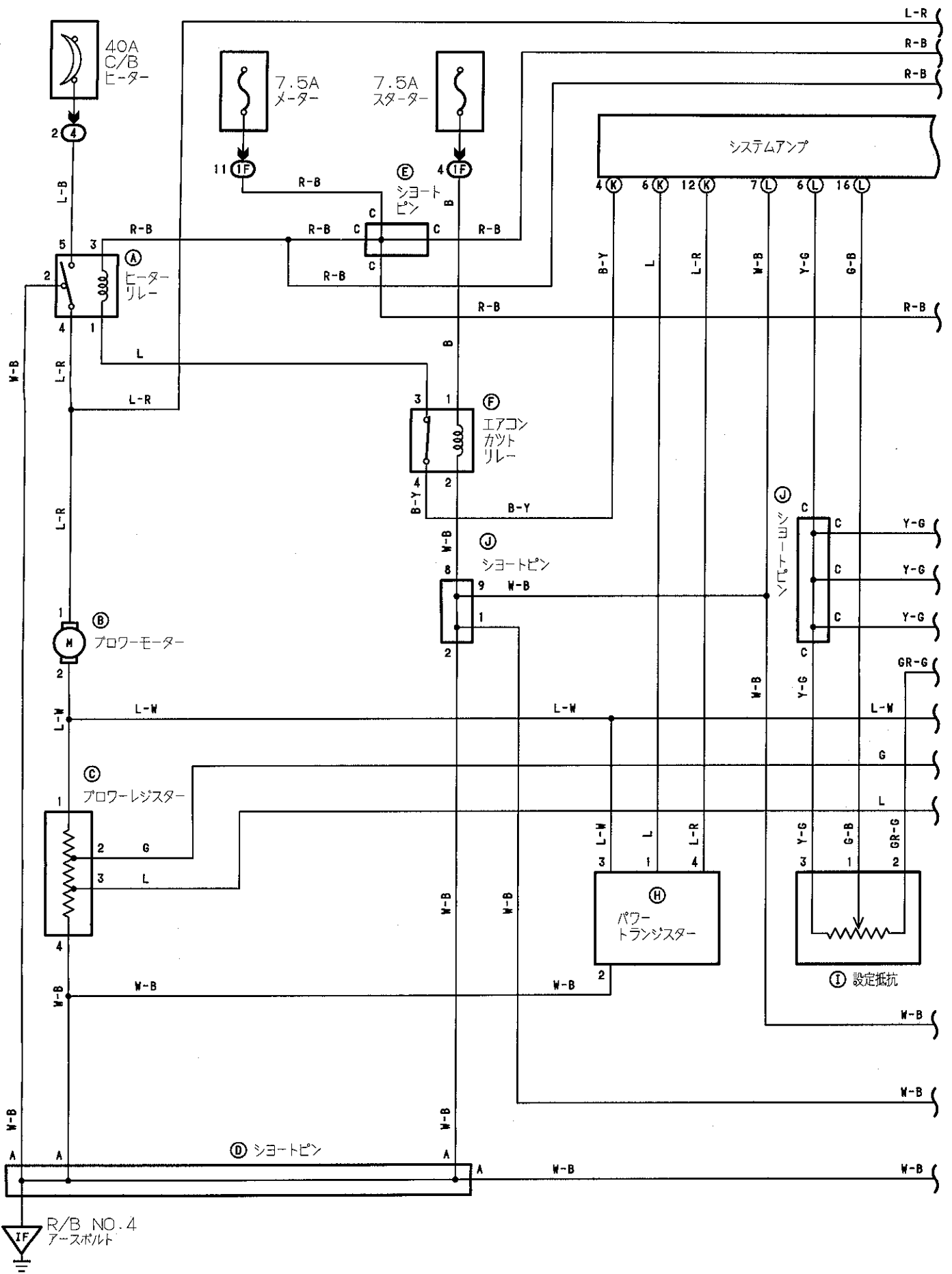
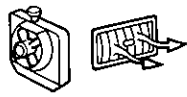

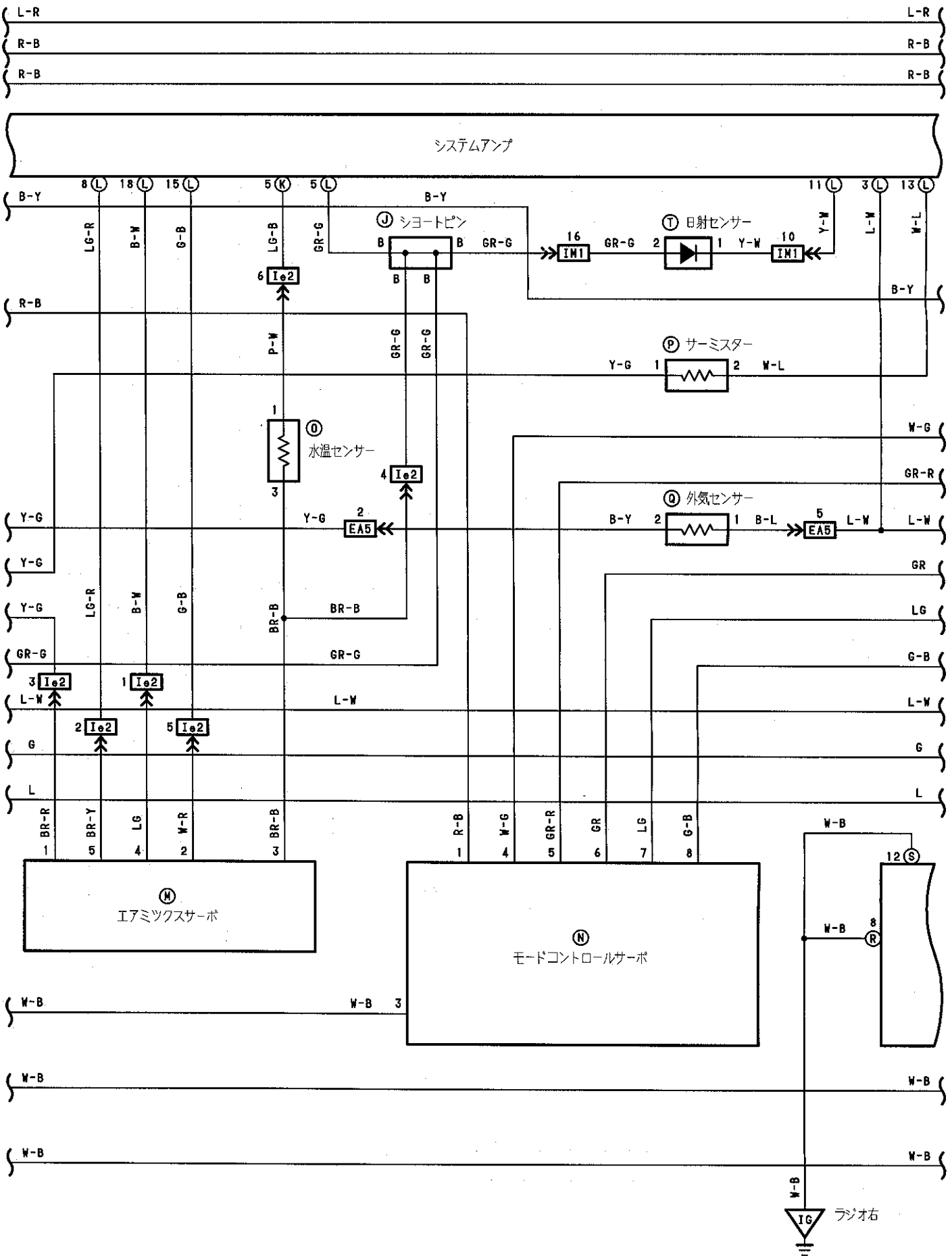
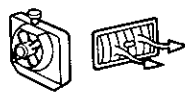

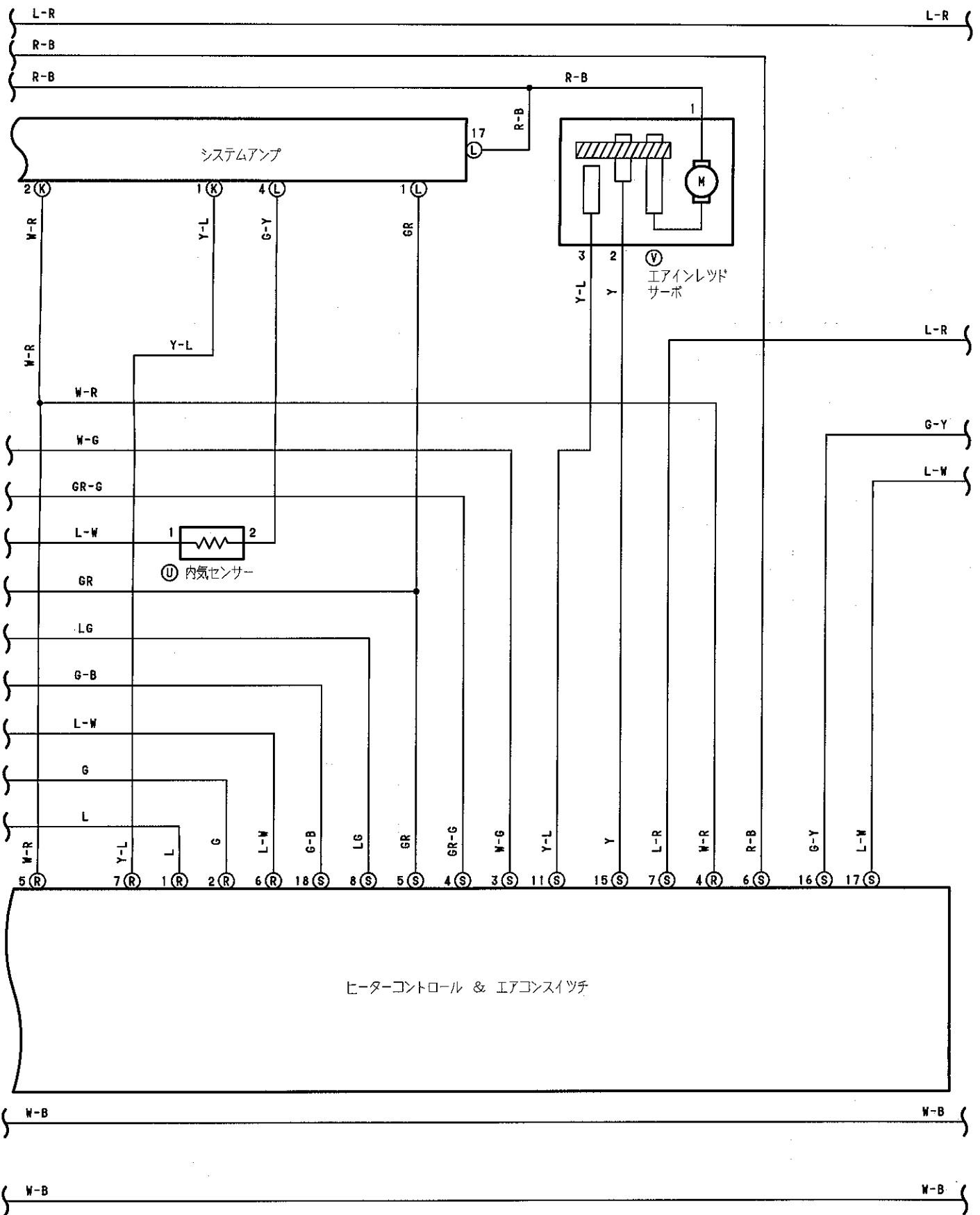
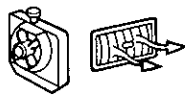

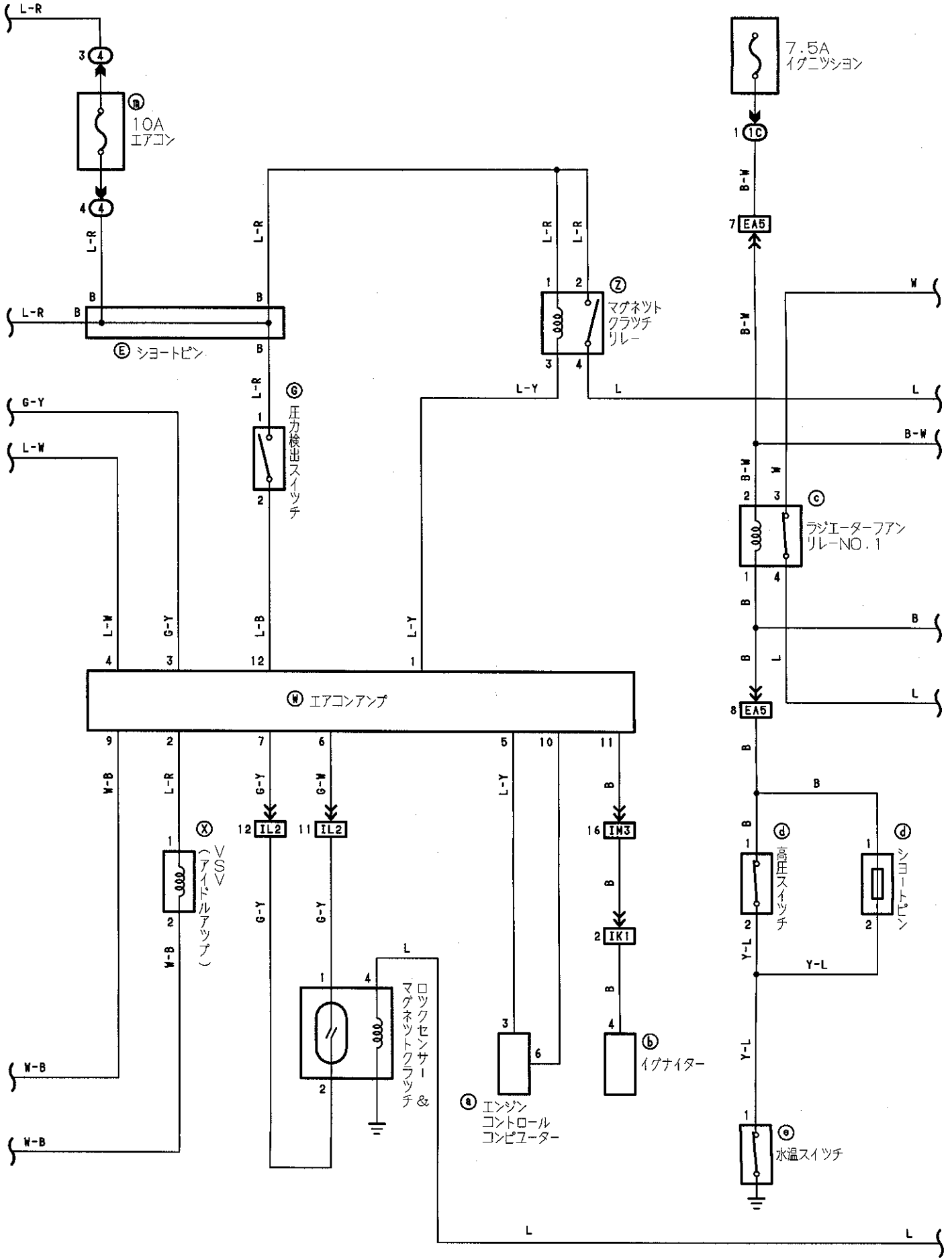



ラジエーターファン & オートエアコンデショナー (4S-FE)

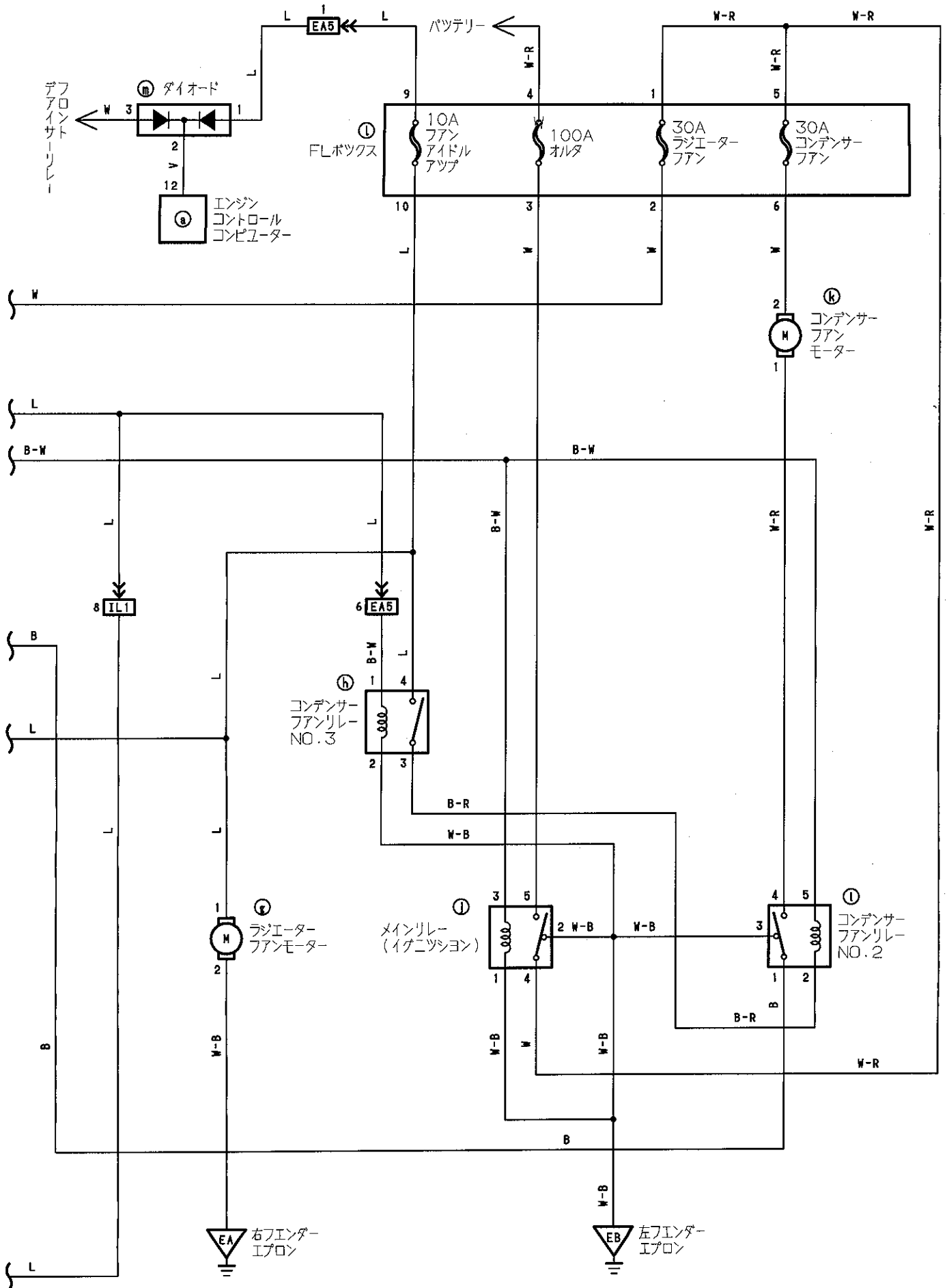

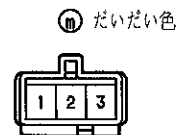
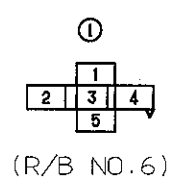
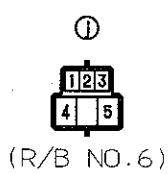
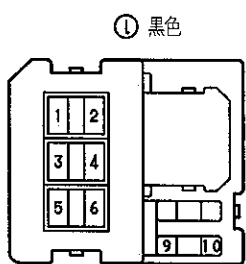
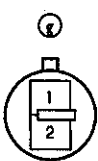
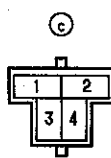
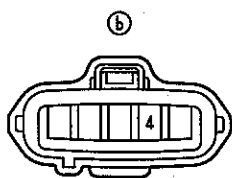
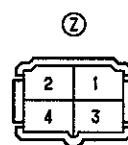
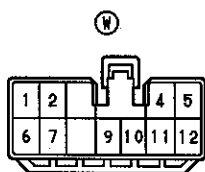
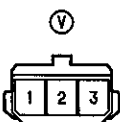
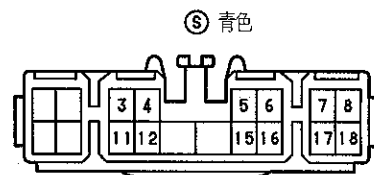
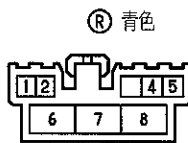
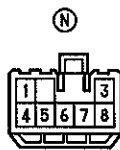
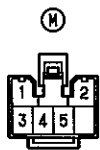
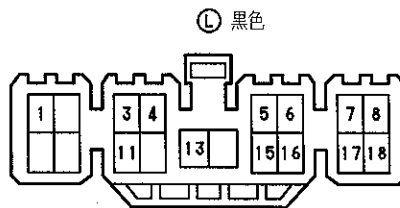
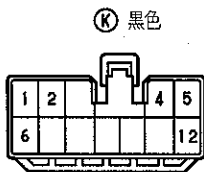
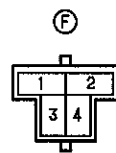
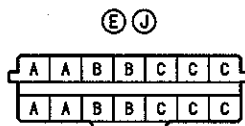
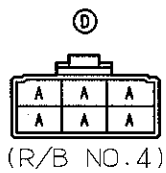
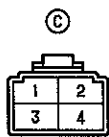
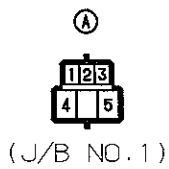
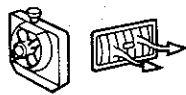



IC

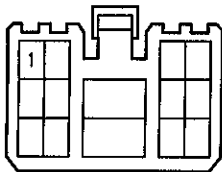

IF

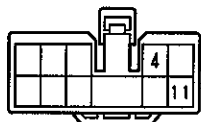

EA5 灰色

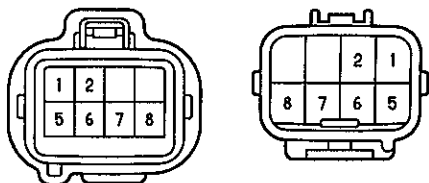

IK1 IM1 IM3

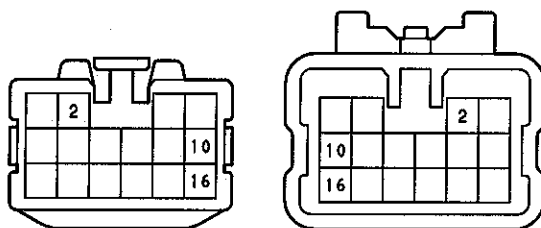

IL1 濃灰色

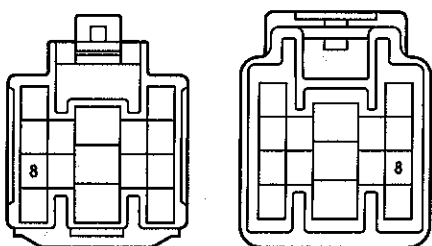

IL2 濃灰色

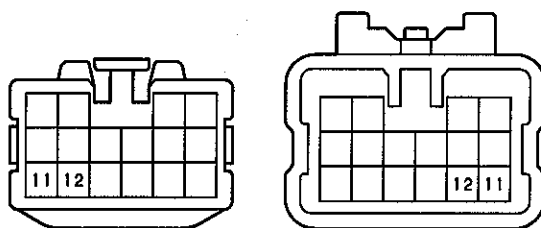

Ie2

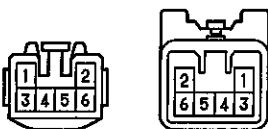



オートエアコンデショナー
(1G-FE Gグレード)

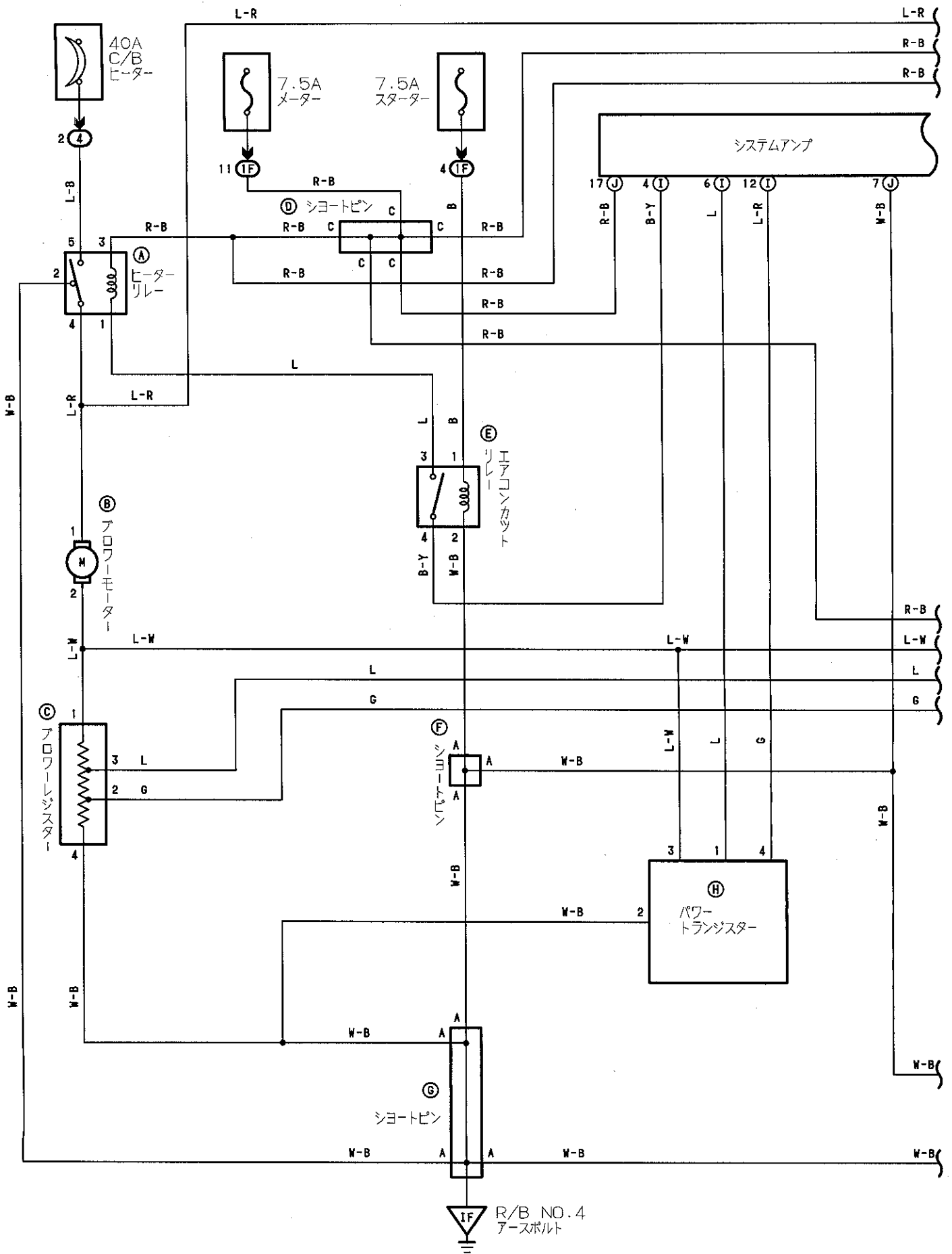

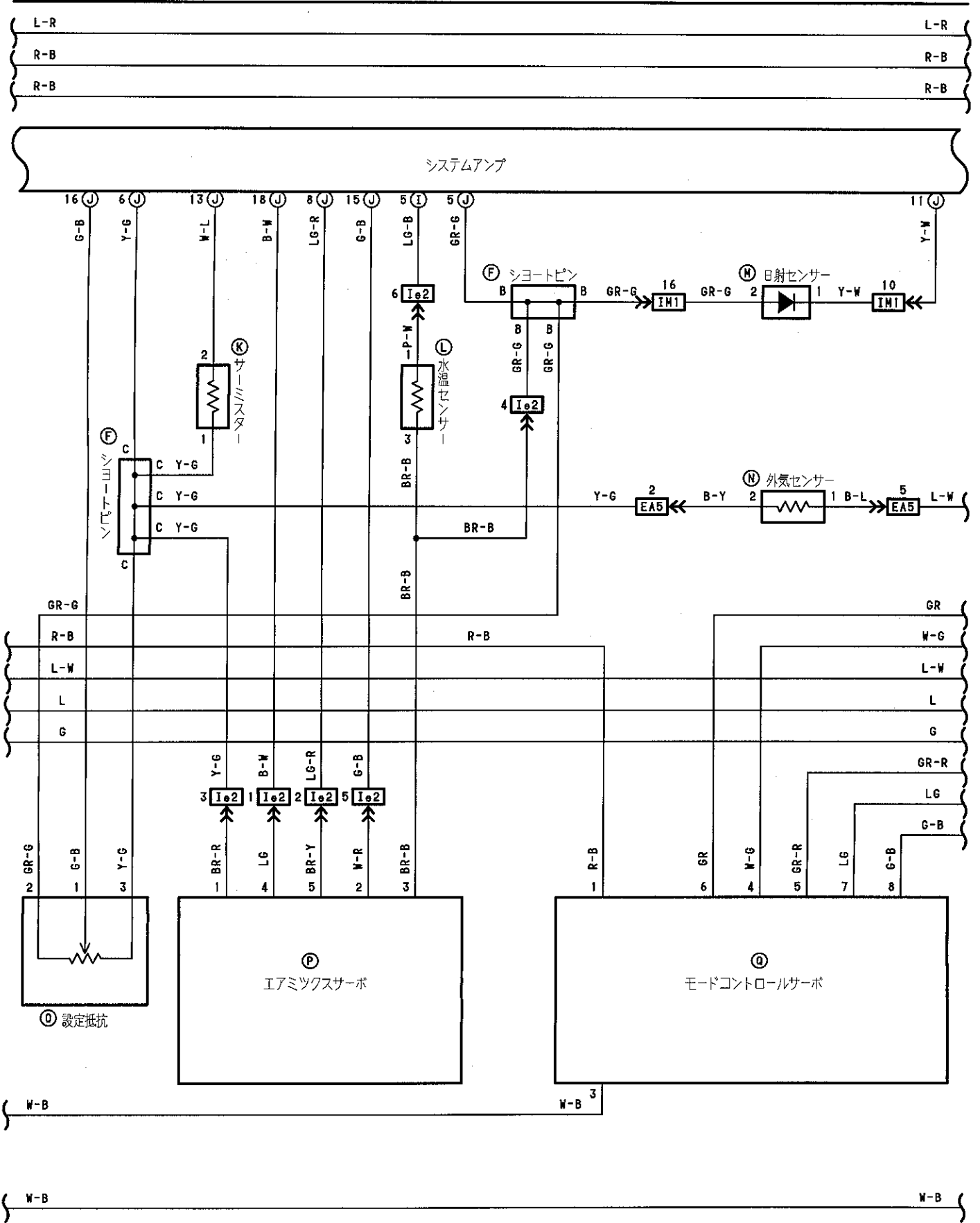

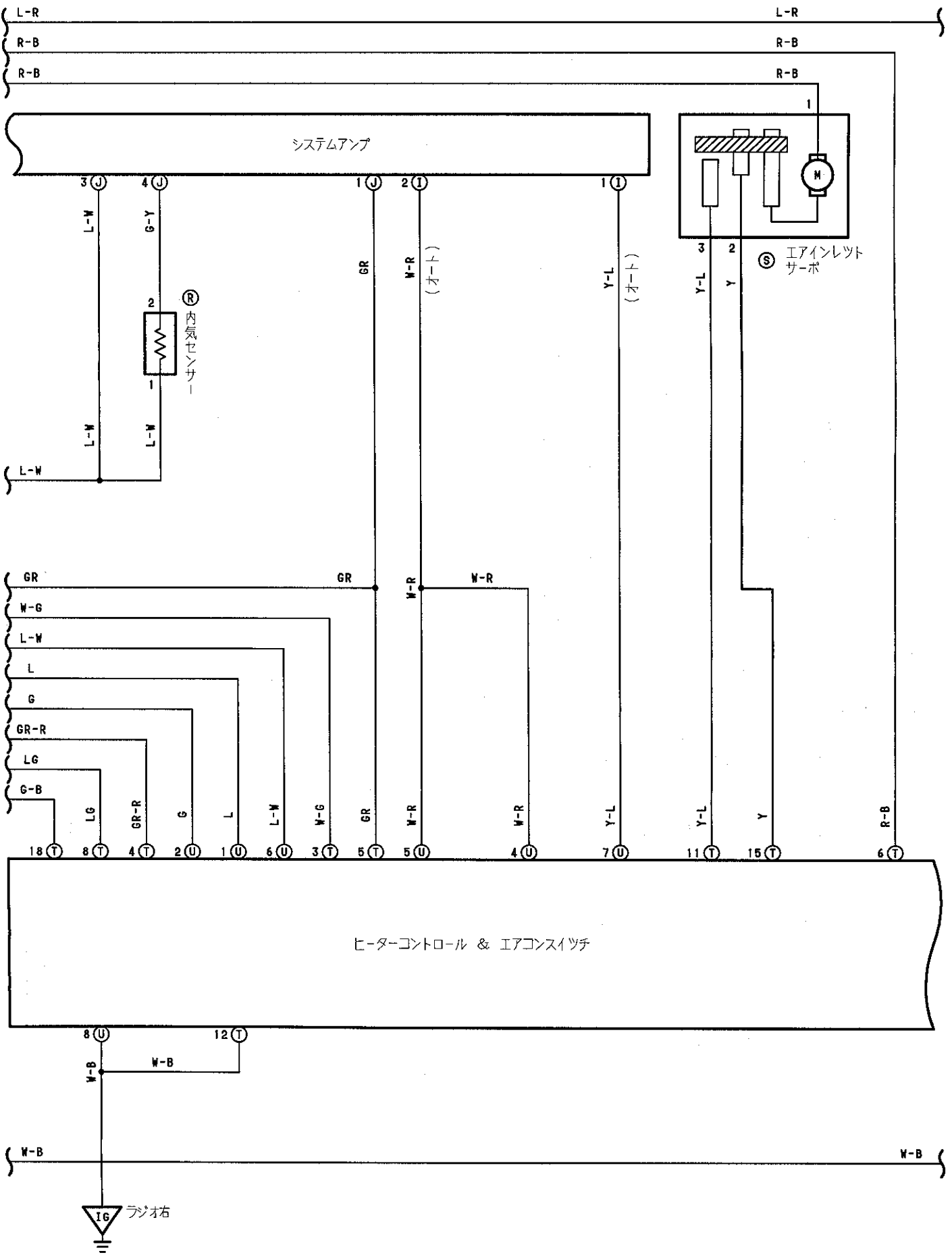

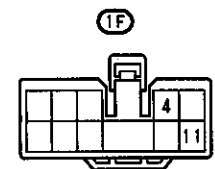
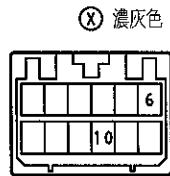
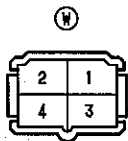
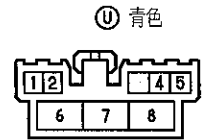
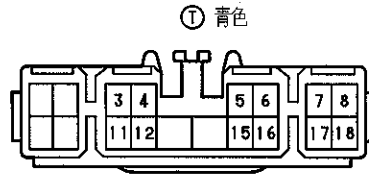
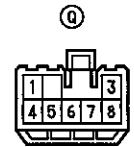
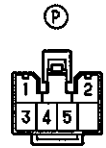
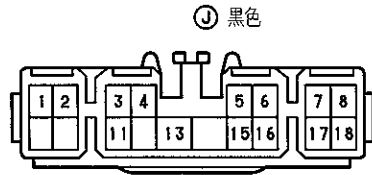
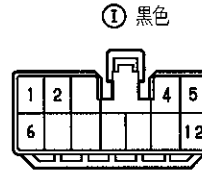
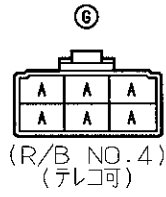
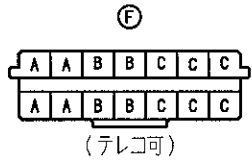
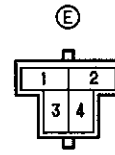
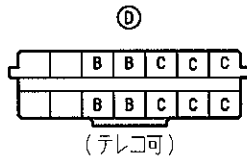
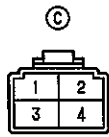
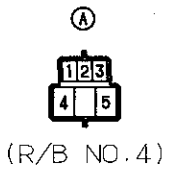



EA5 灰色

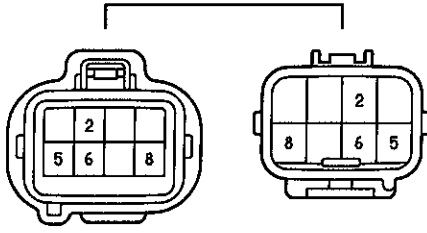

IL1 濃灰色

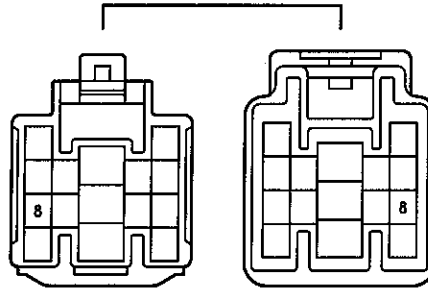

IM1

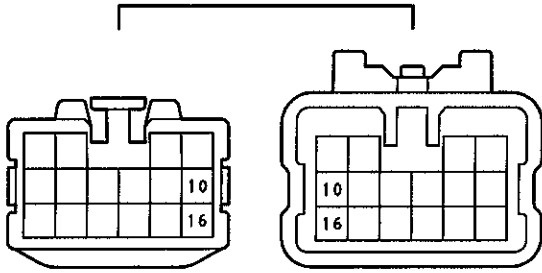

1e2

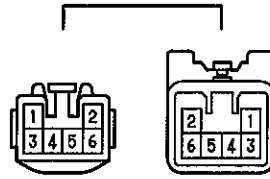

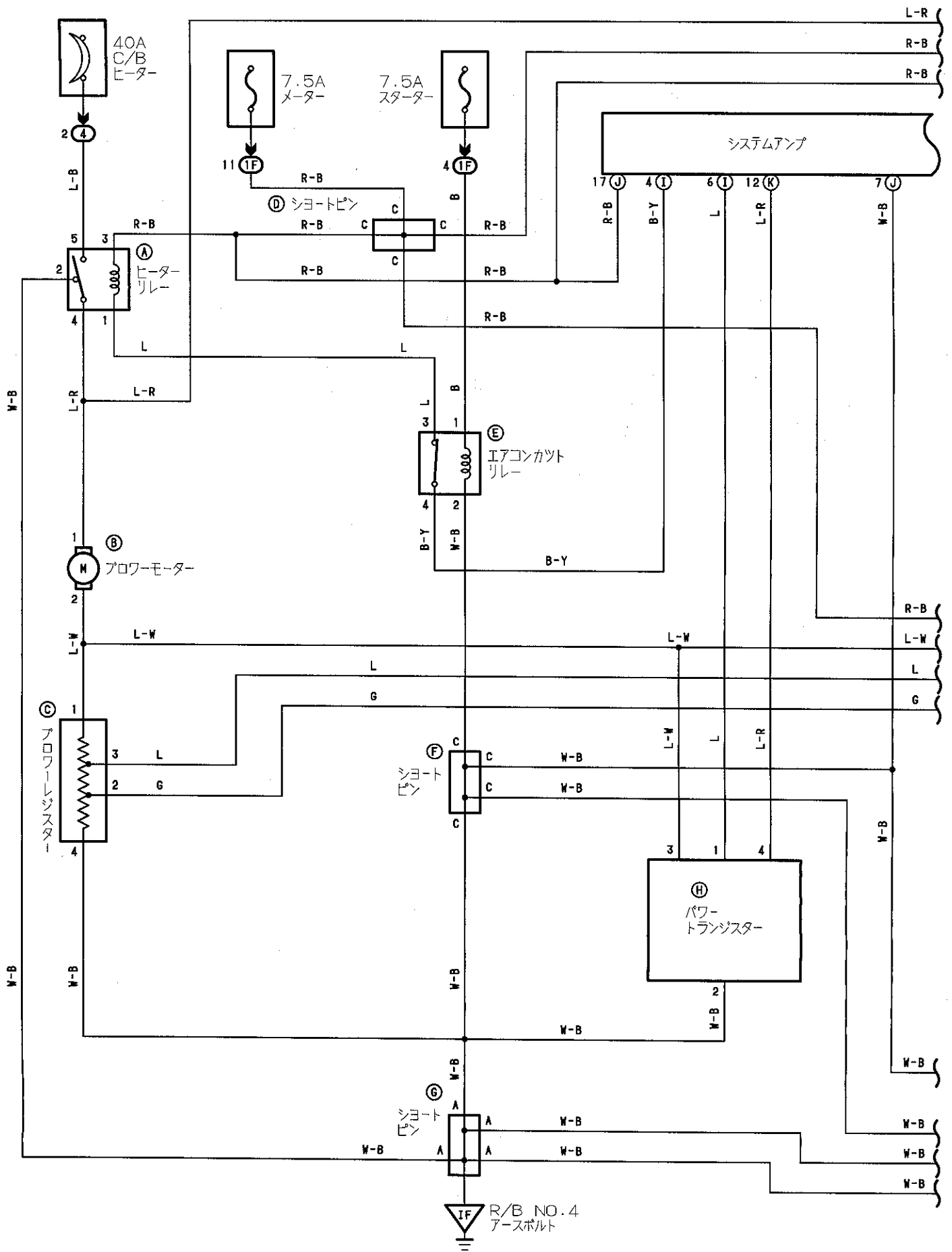

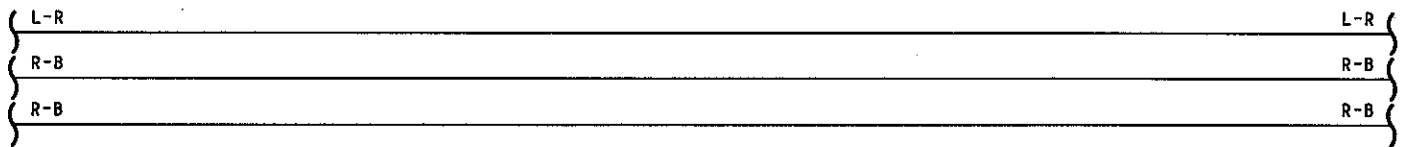

システムアップ

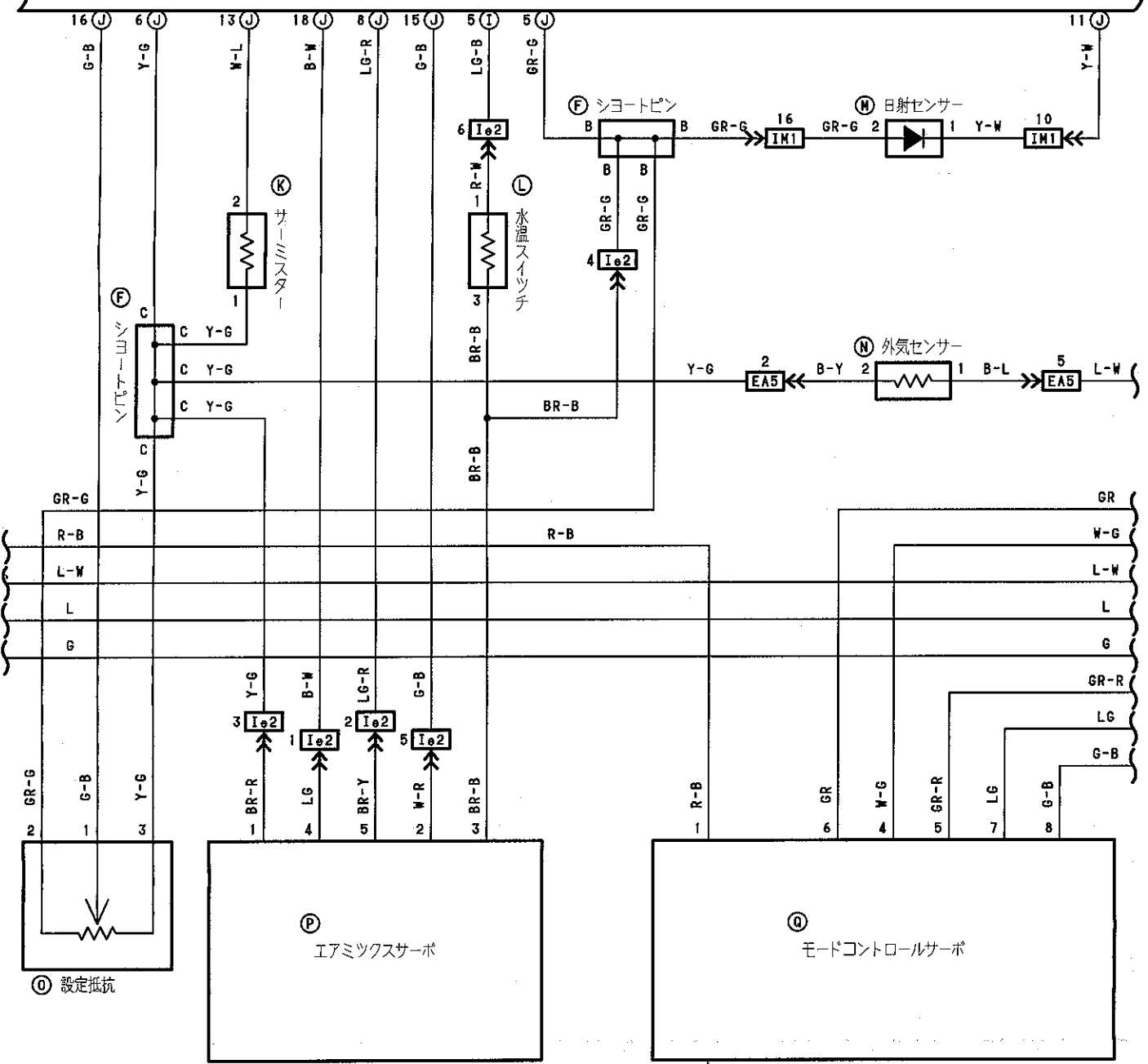

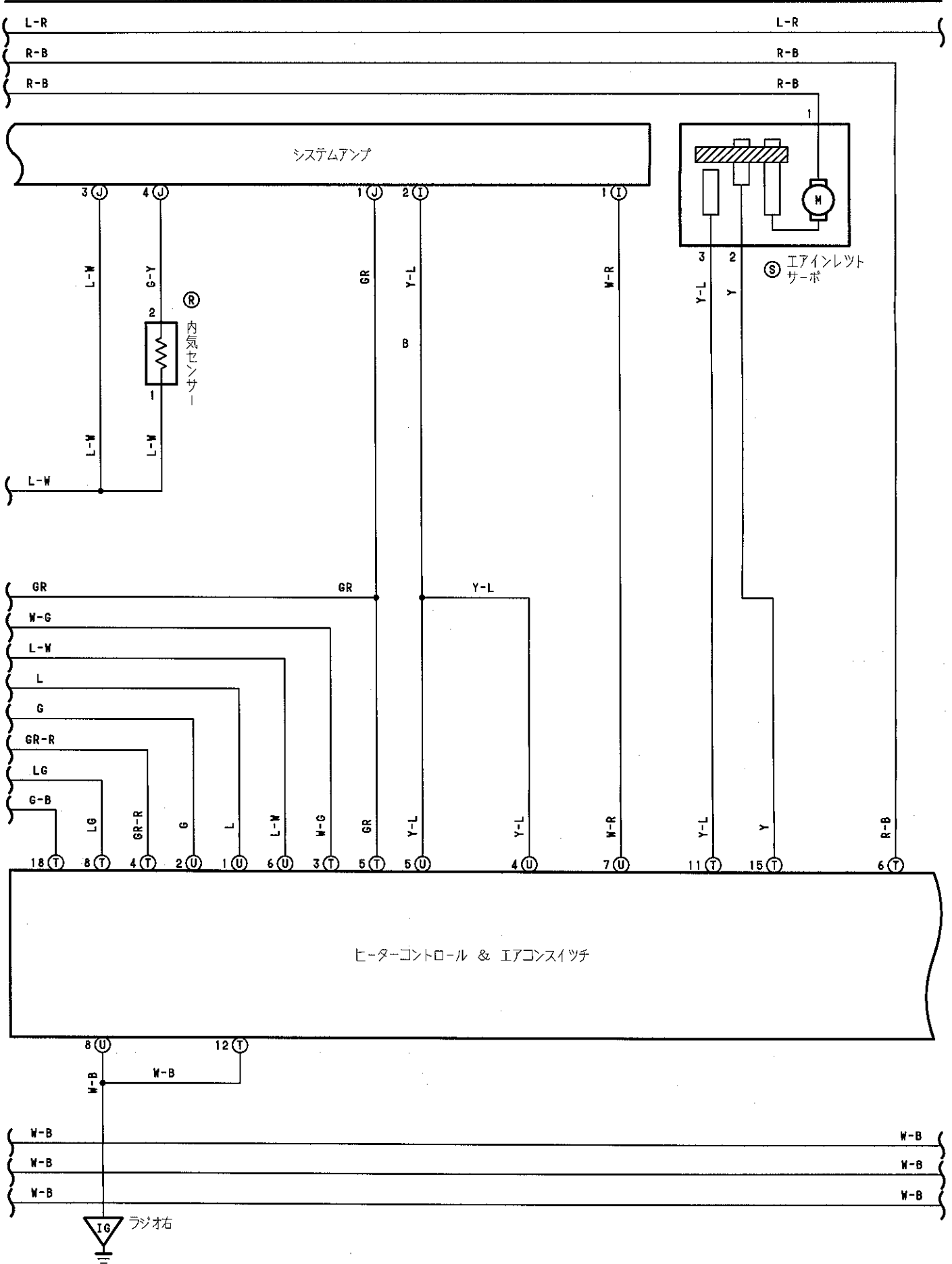

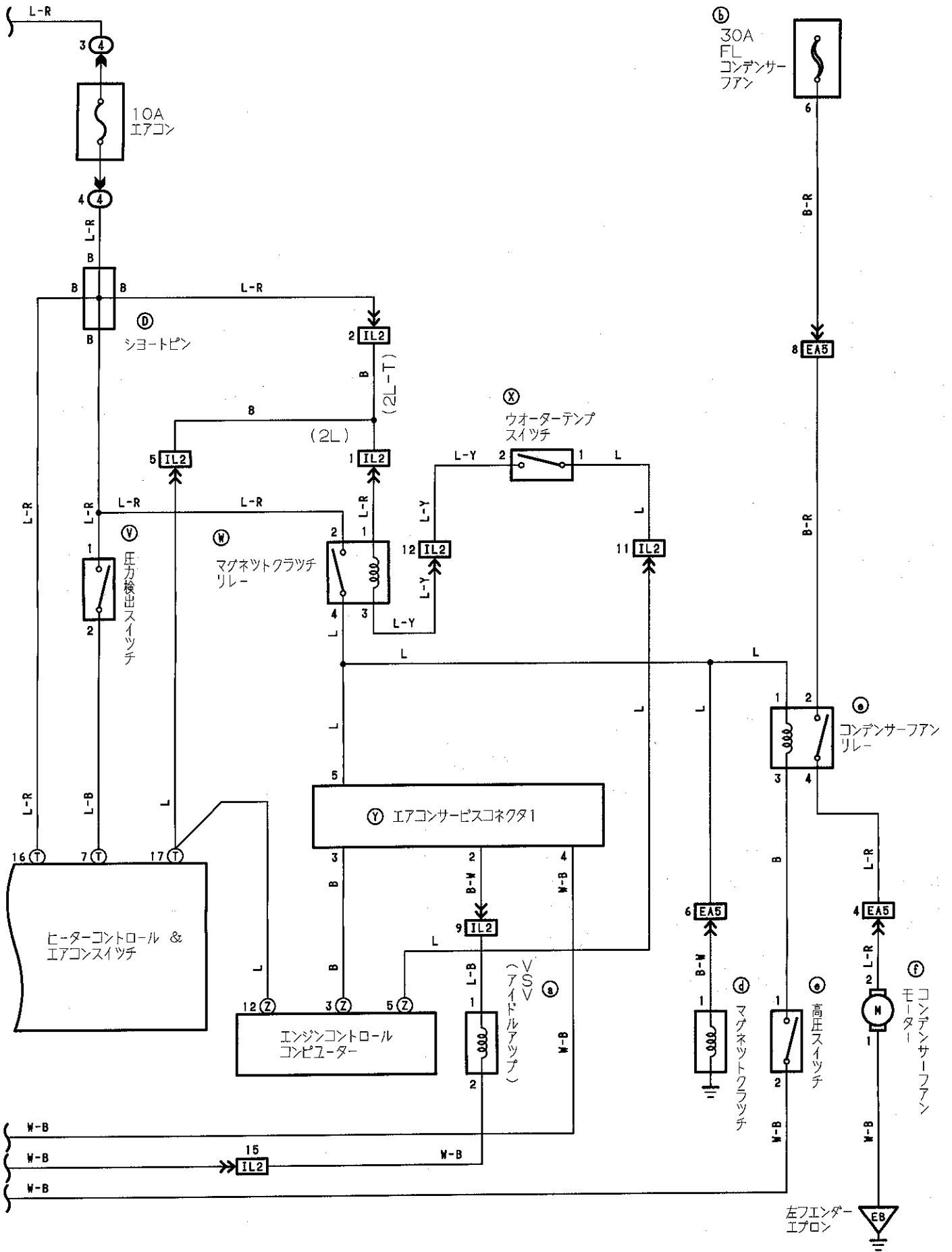

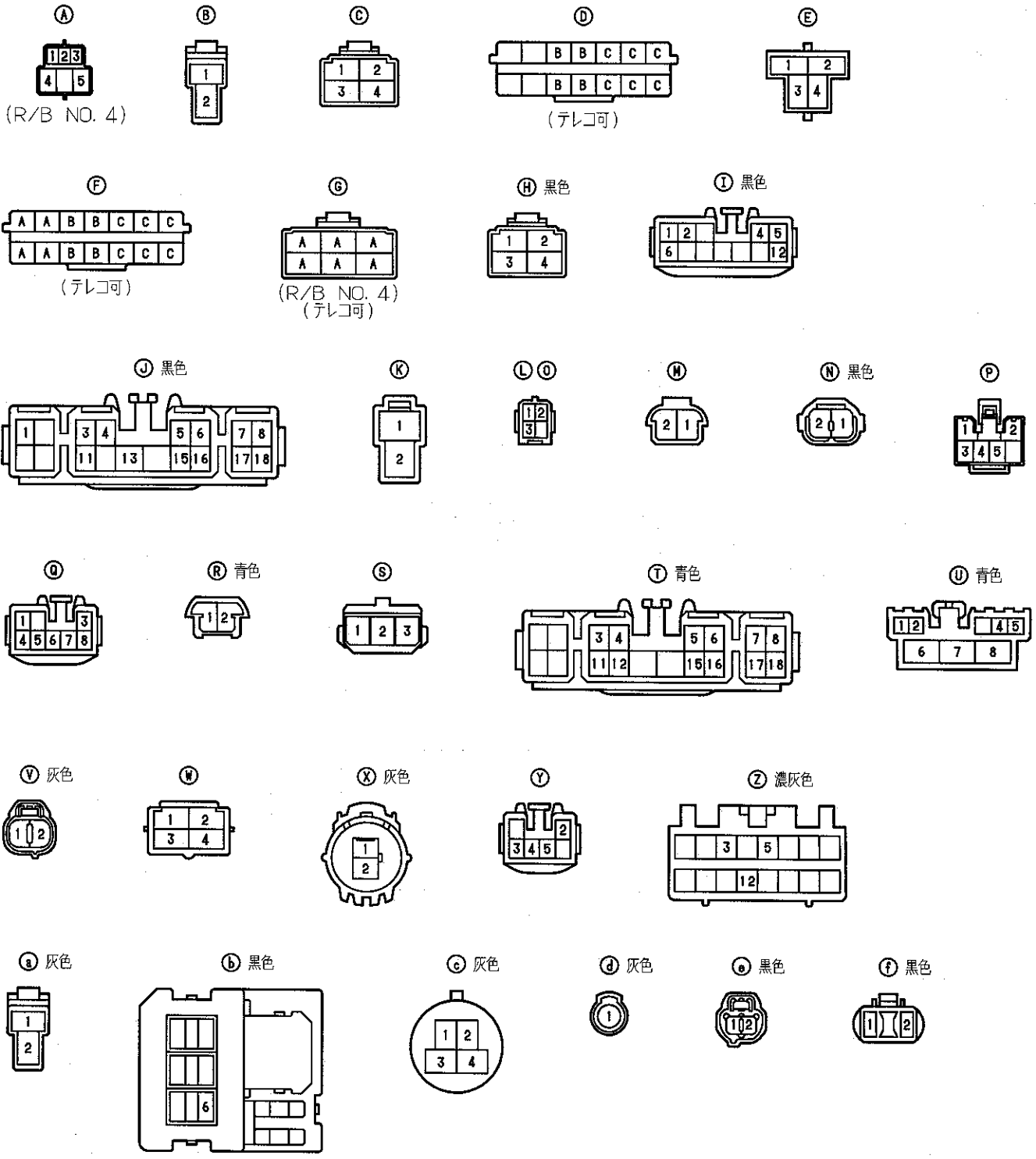

1F

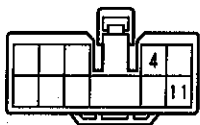

EA5 灰色

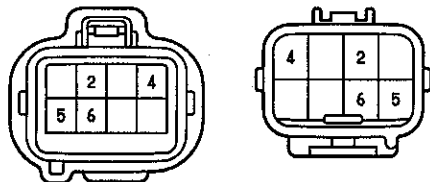

IL2 濃灰色

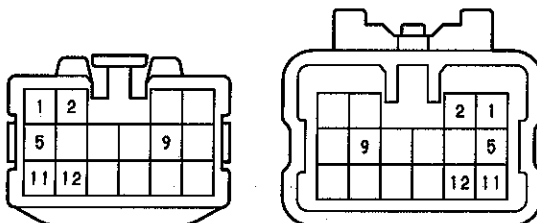

IN1

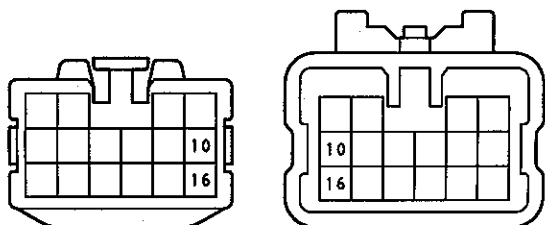

Ie2

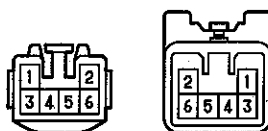

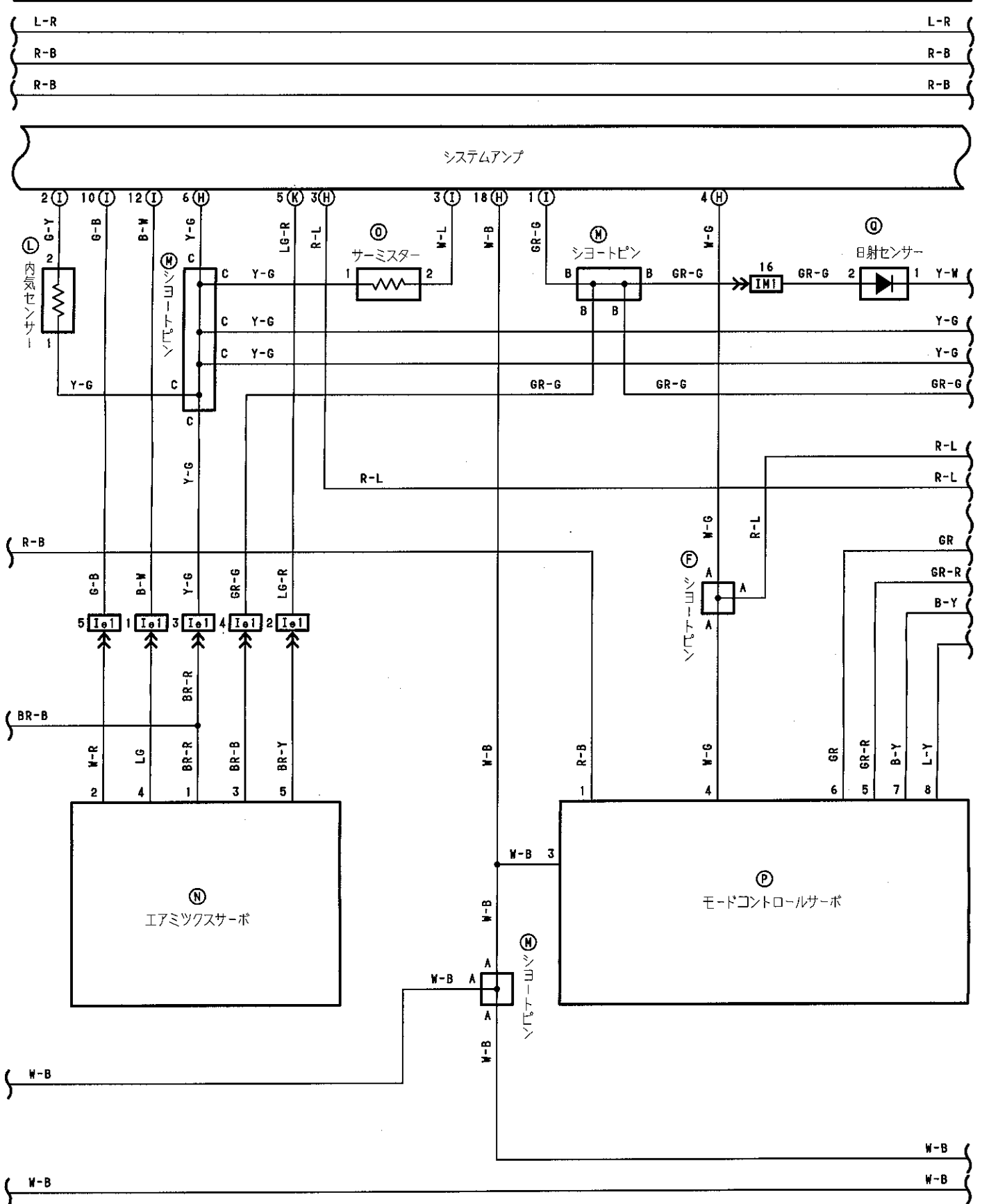

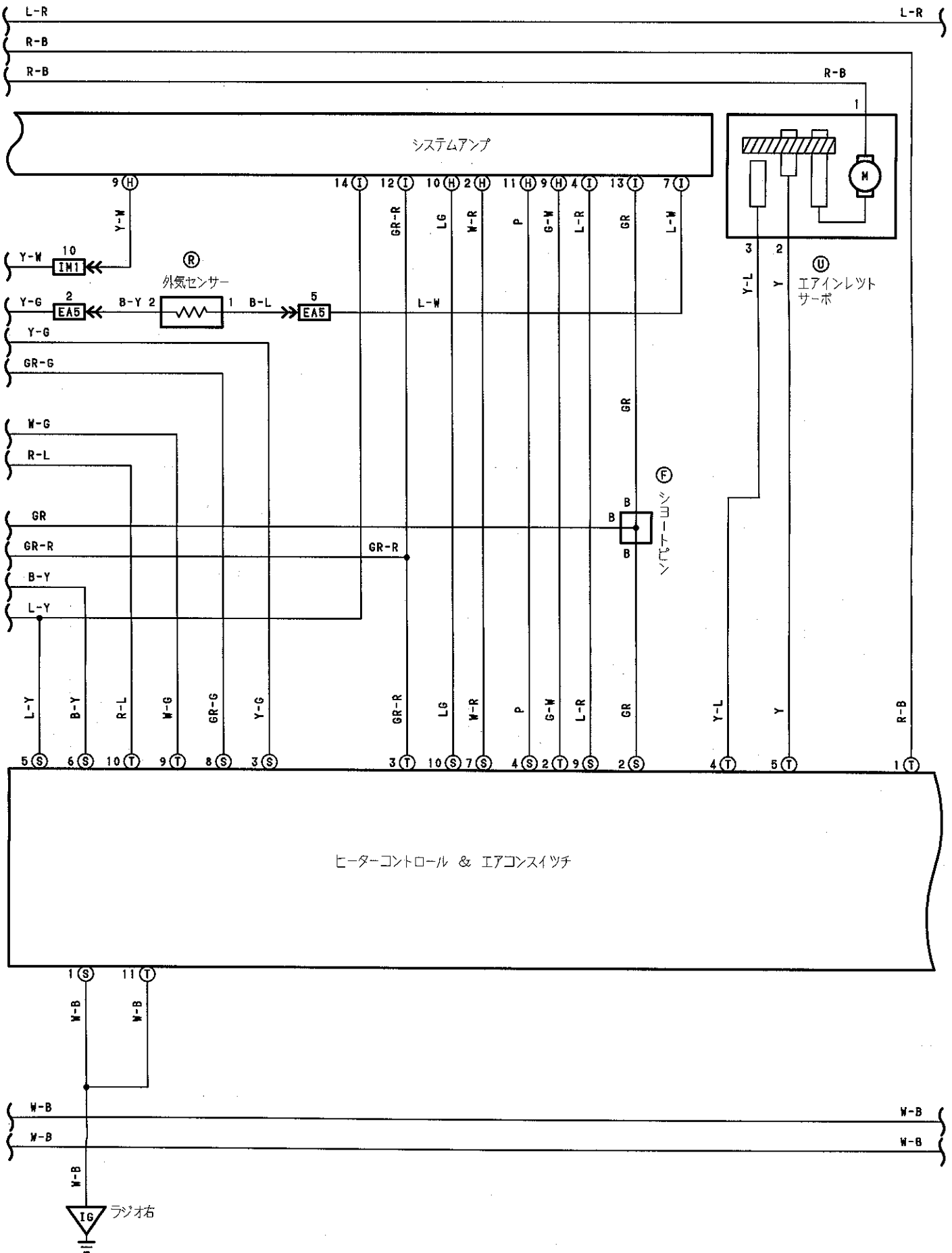

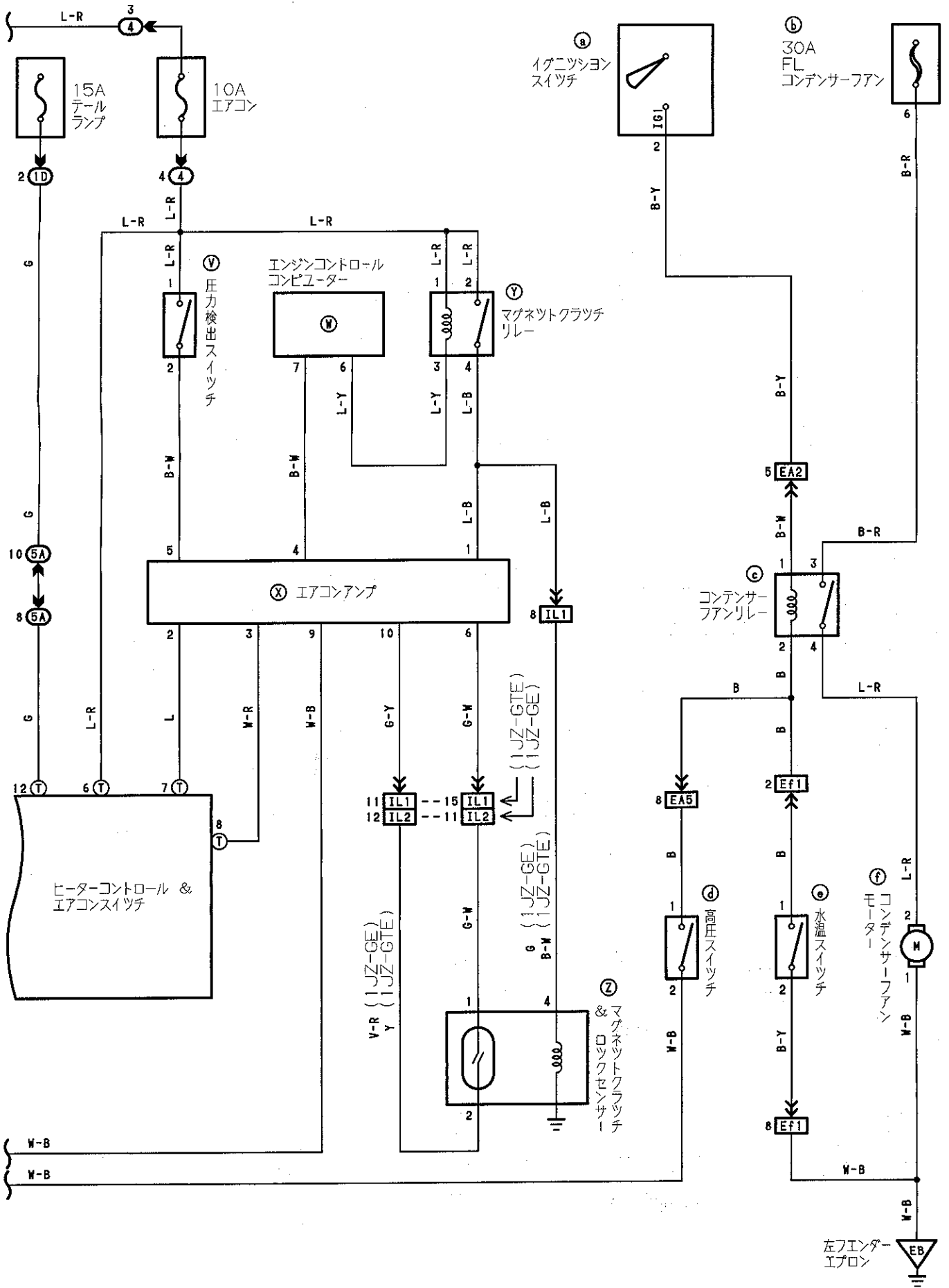

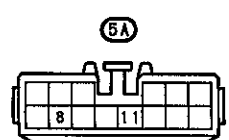
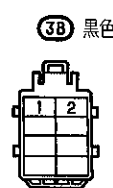
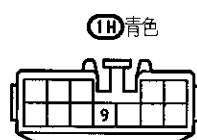
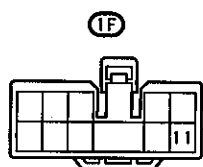
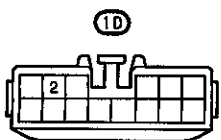
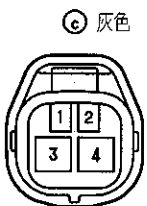
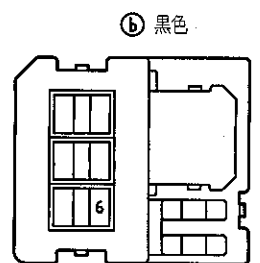
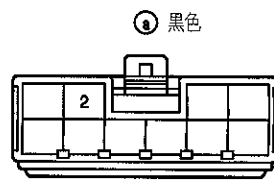
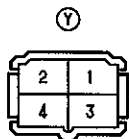
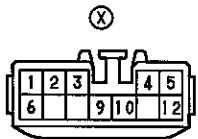
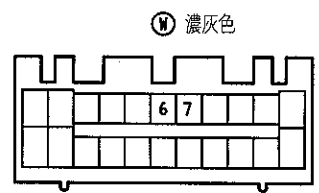
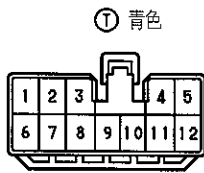
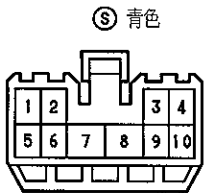
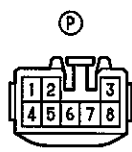
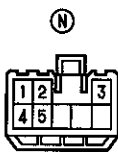
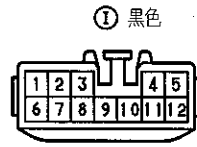
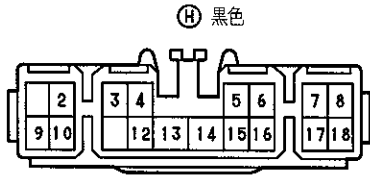
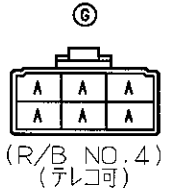
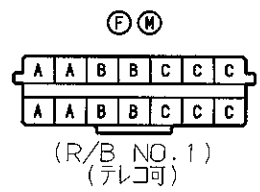
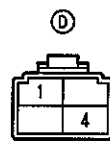
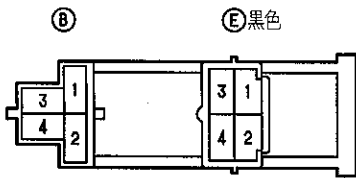
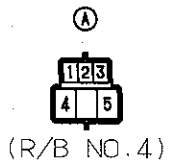



EA2 灰色

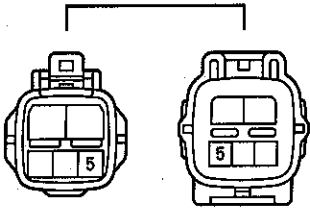

EA5

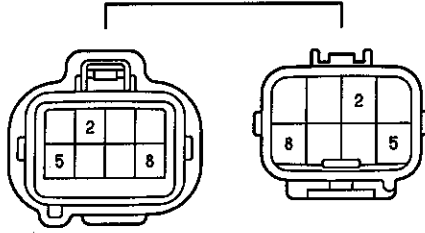

Ef1

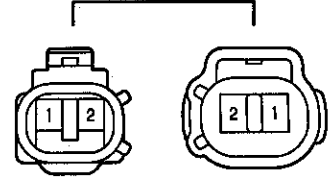

IL1 濃灰色

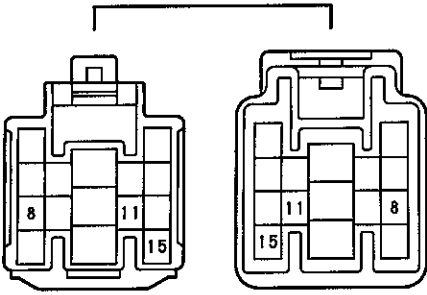

IL2 濃灰色

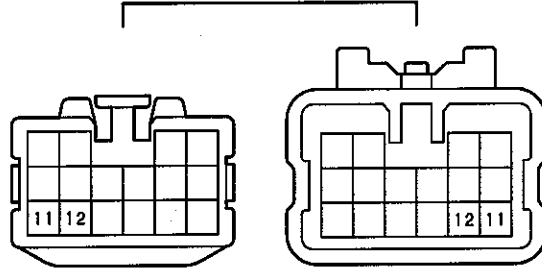

IM1

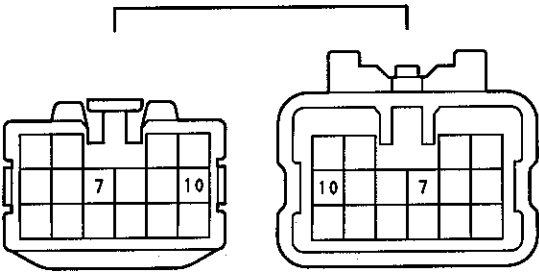

Ie1

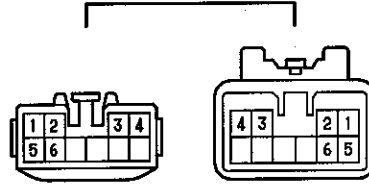



オートエアコンデショナー (1G-FE, 1G-GE, 7M-GE)

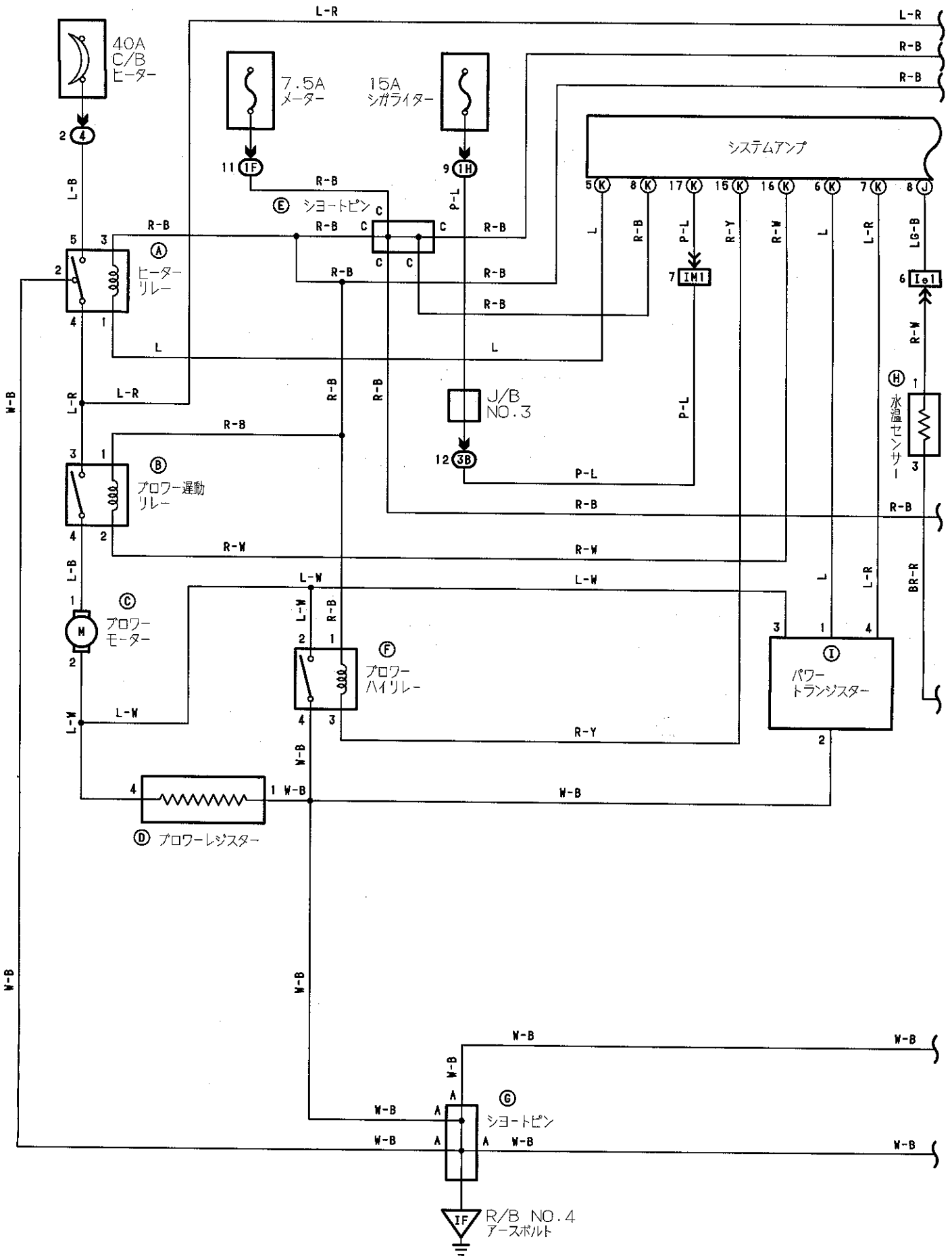

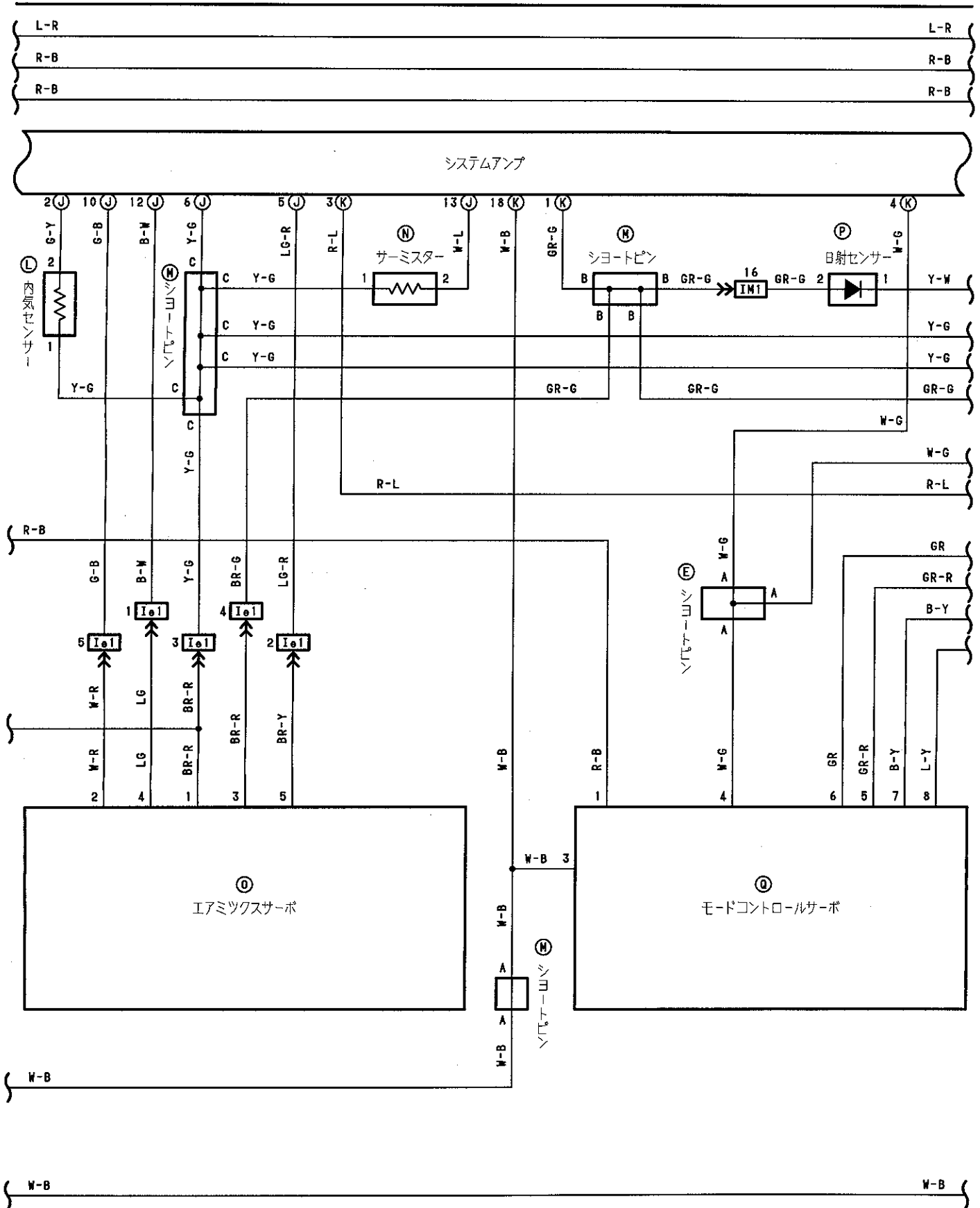

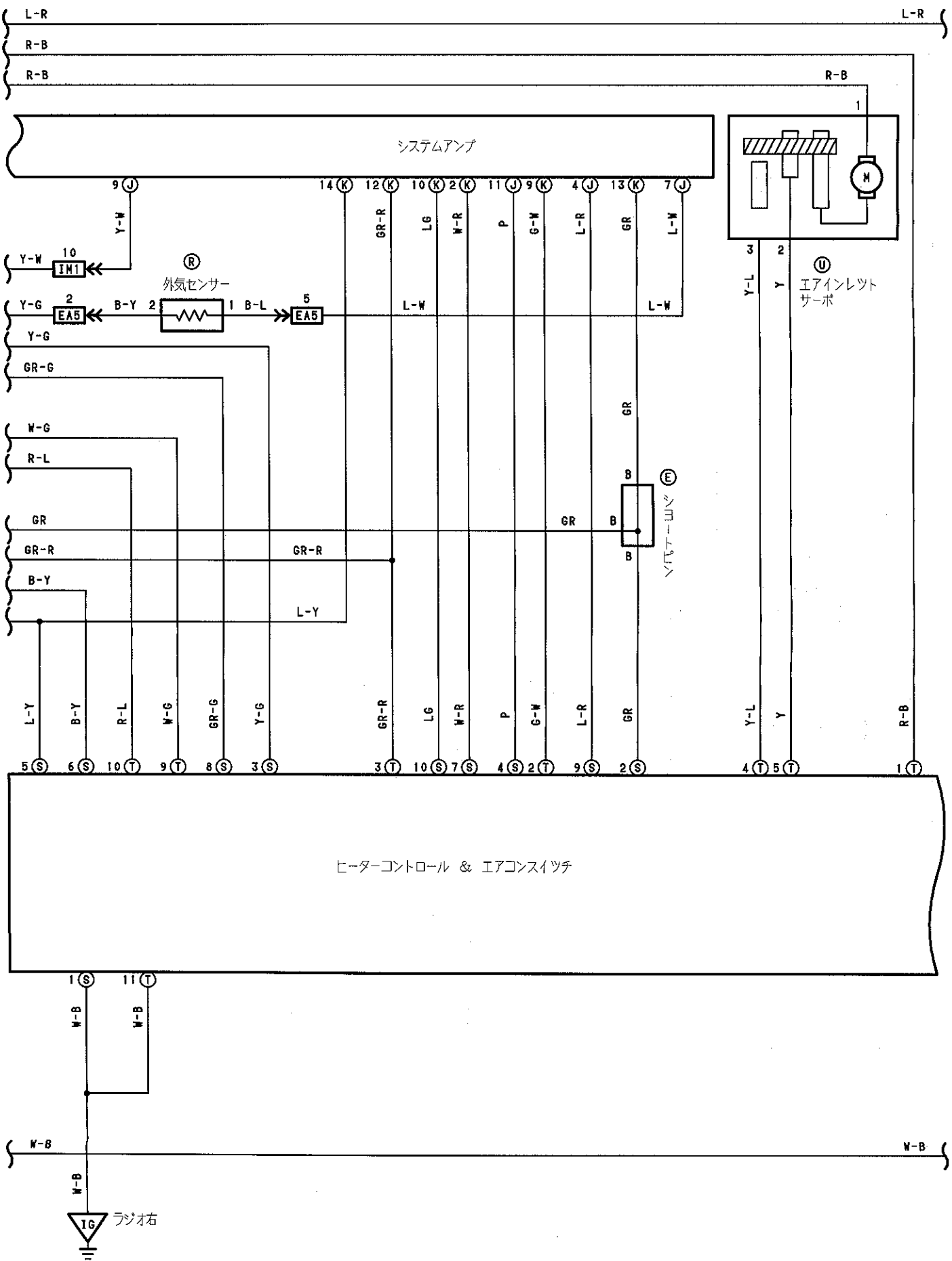

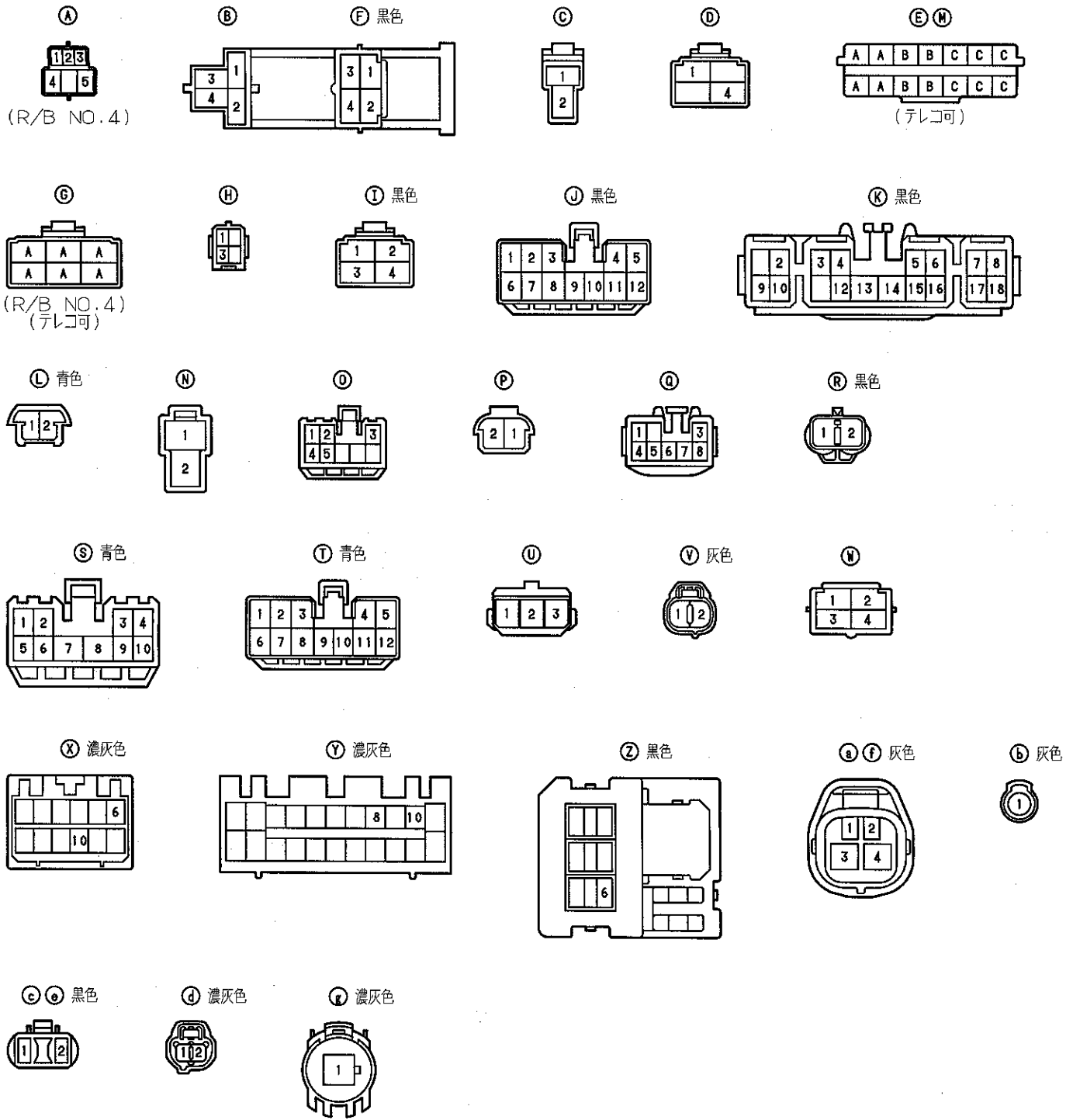

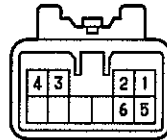
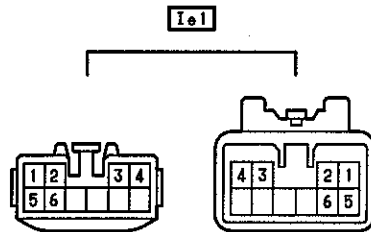
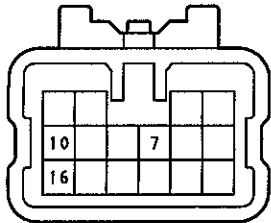
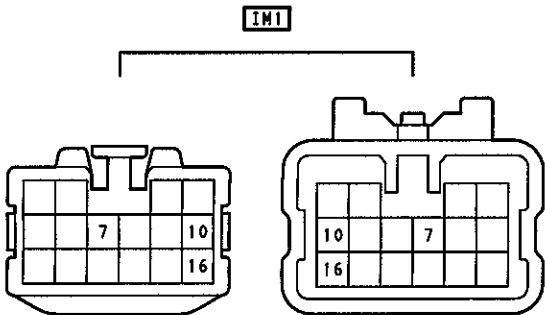
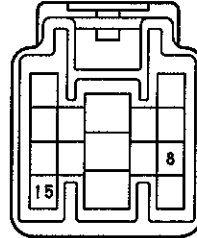
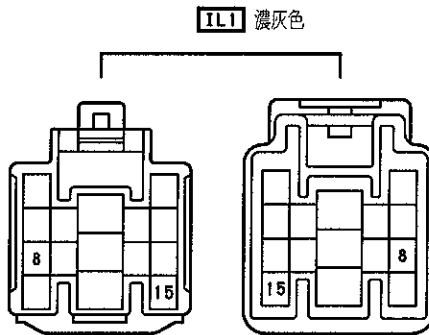
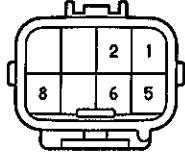
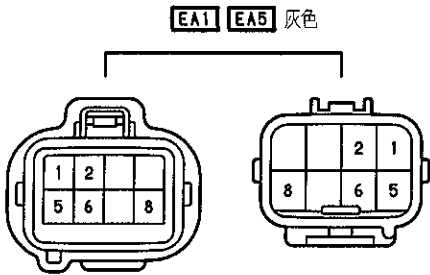
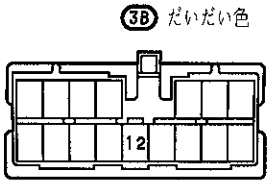
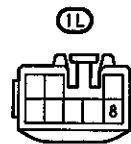
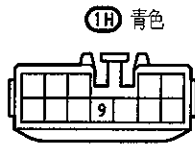
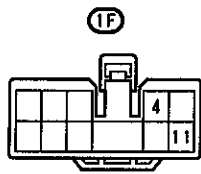
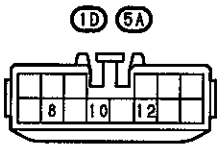

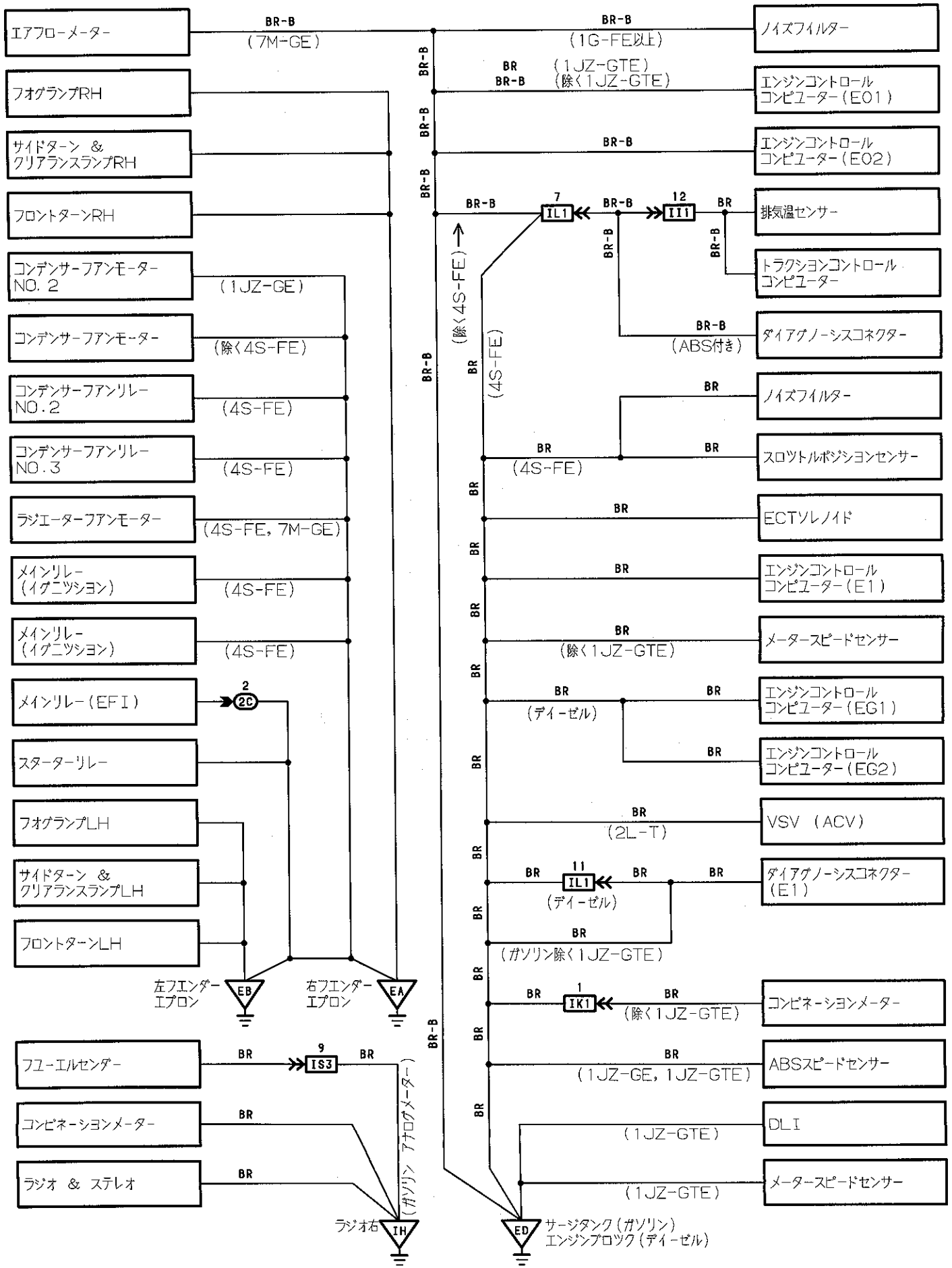

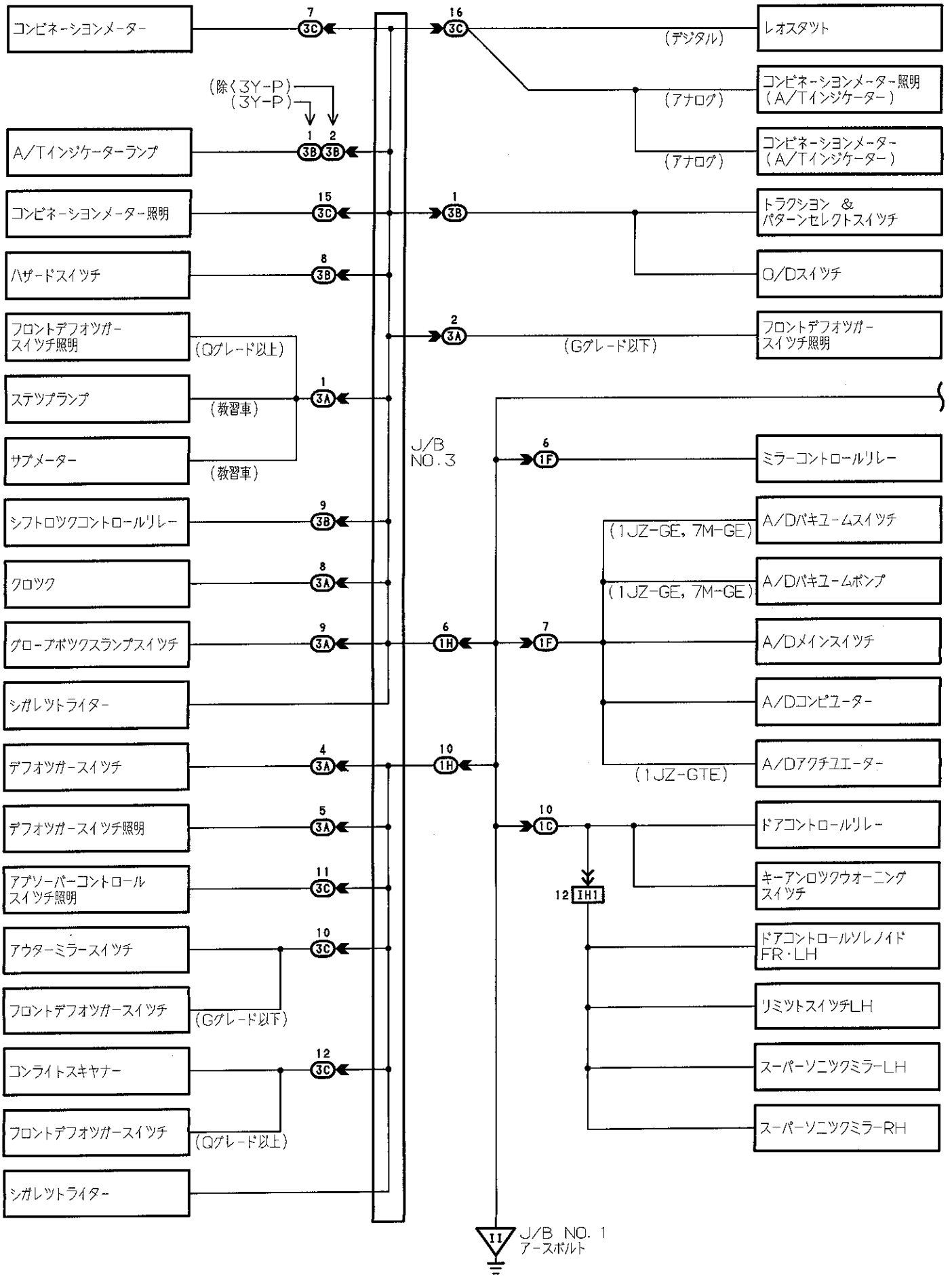

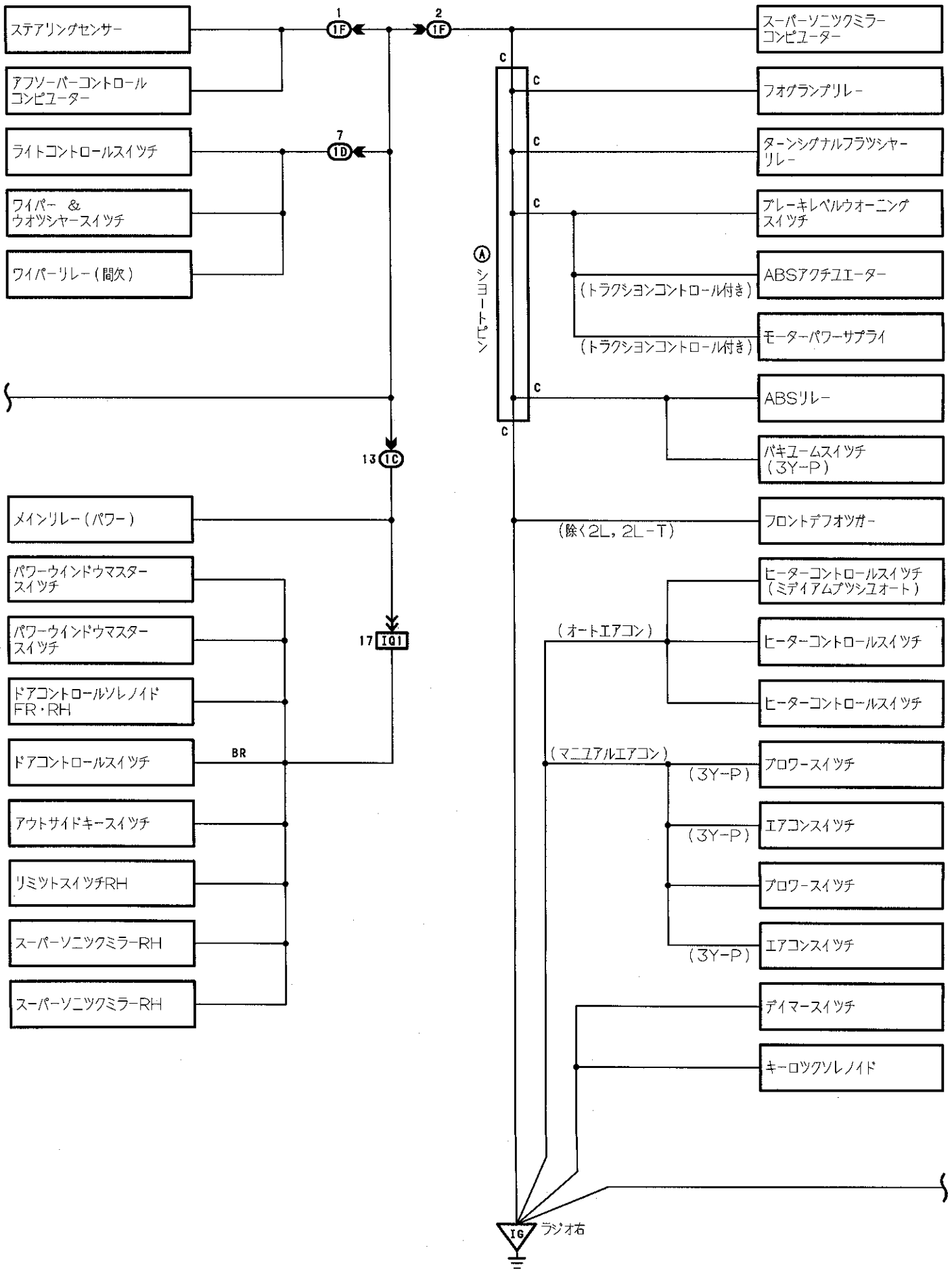

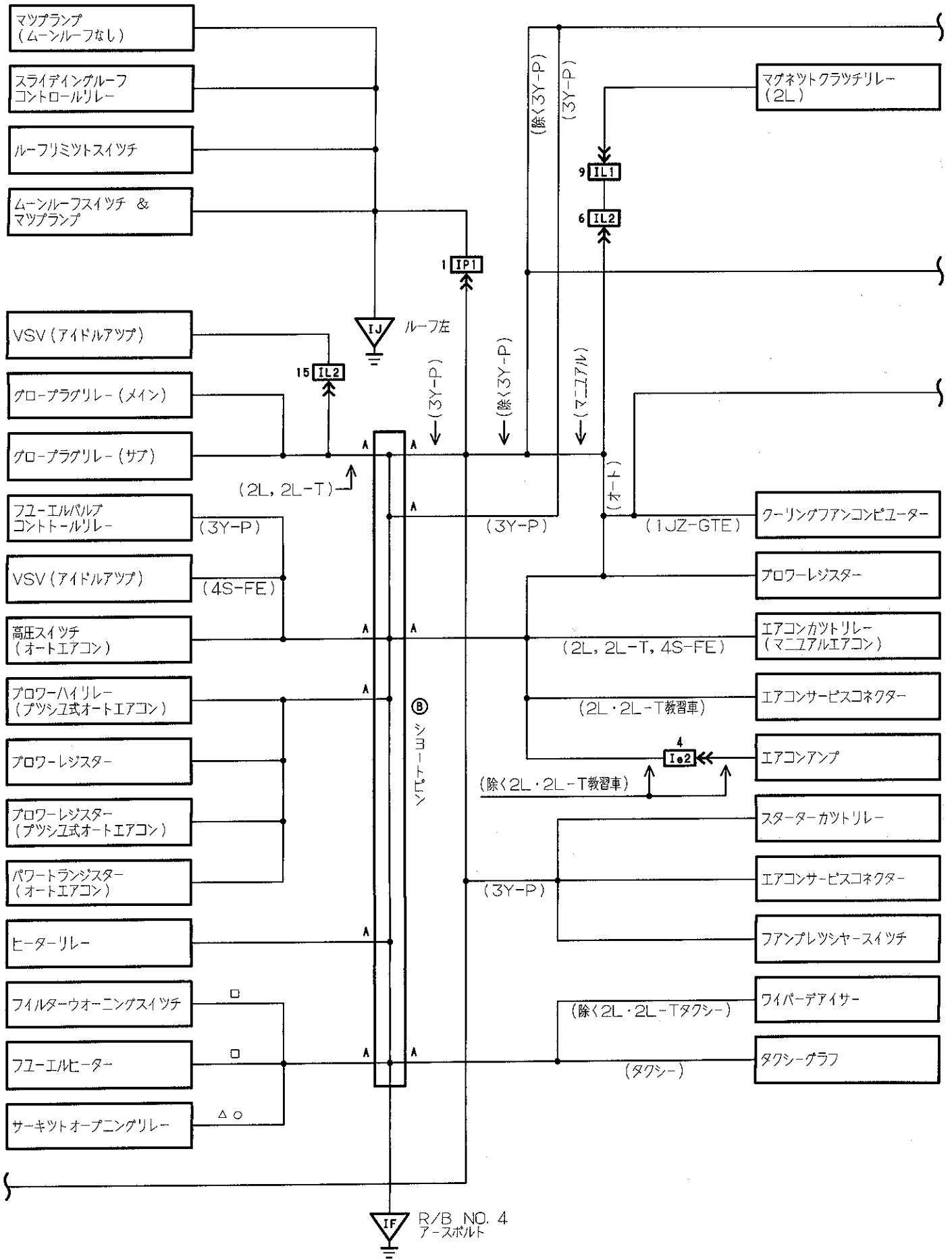

R/B. NO. 4
アースポイント

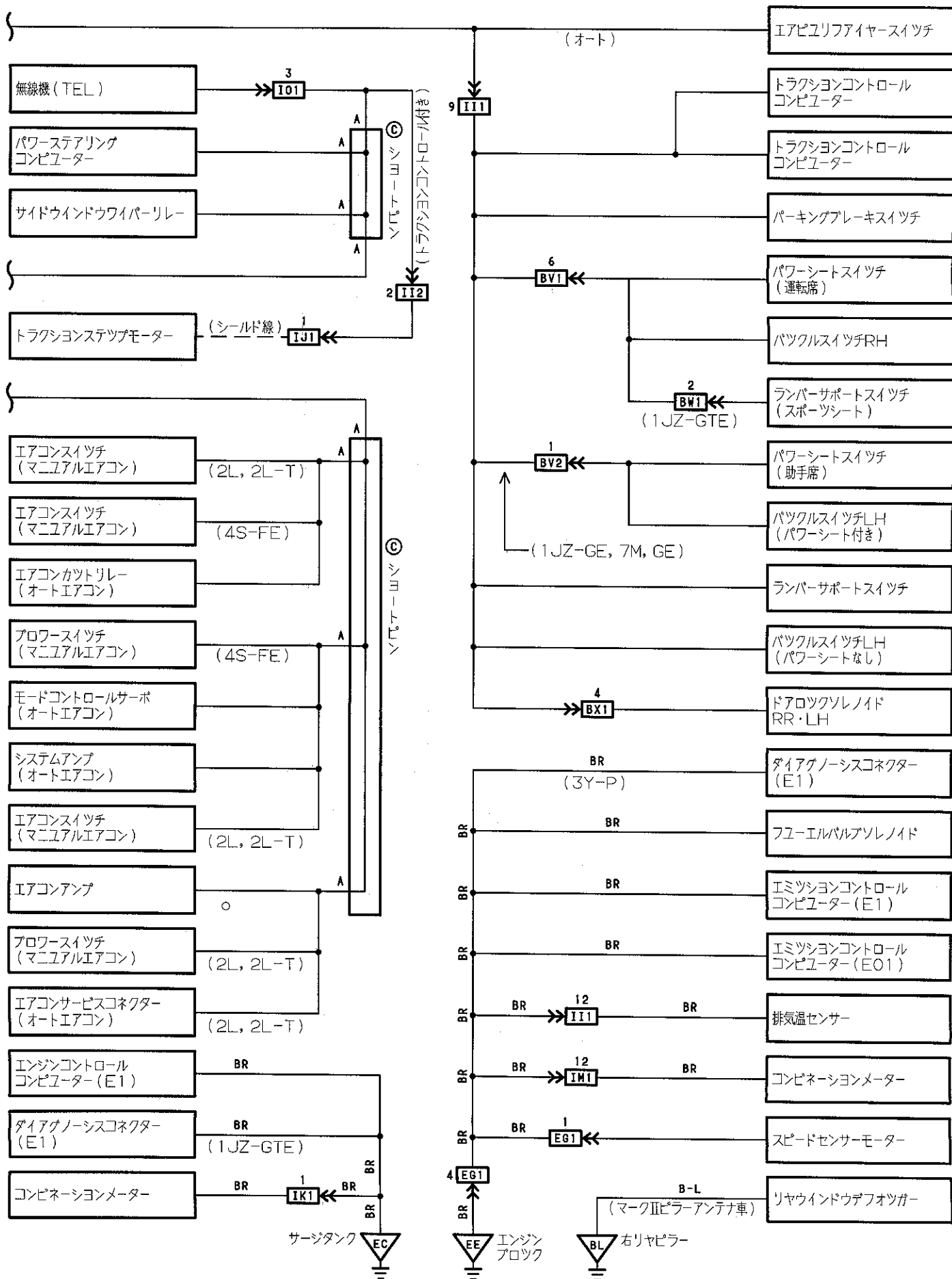

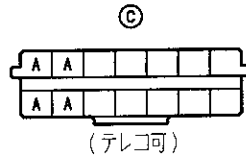
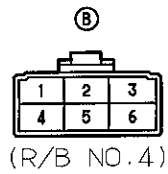
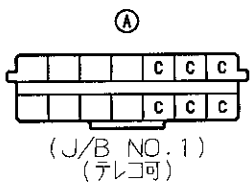
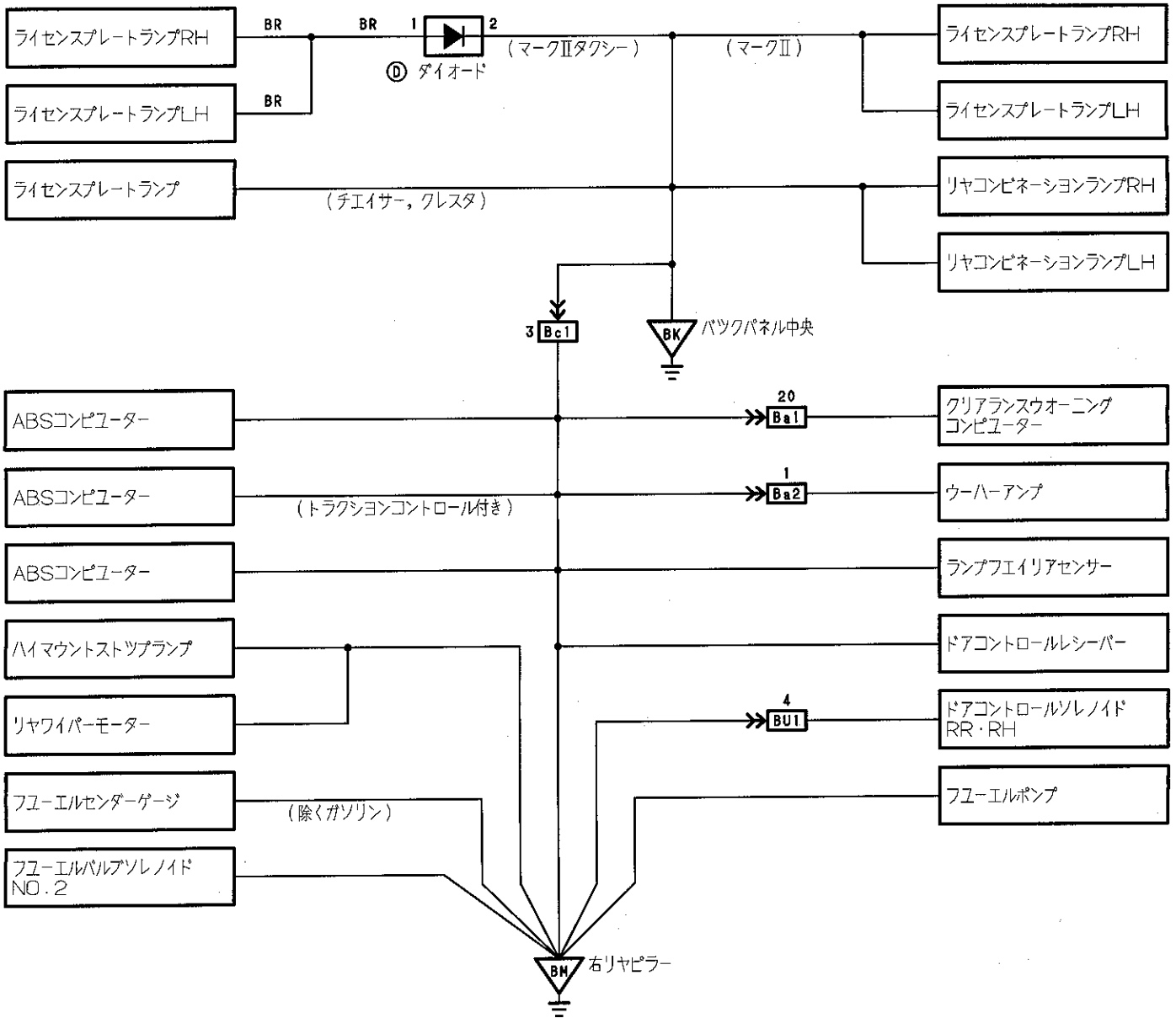

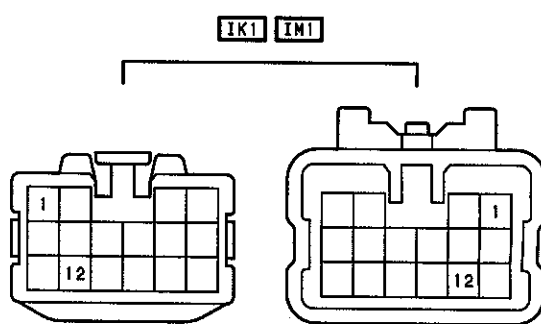
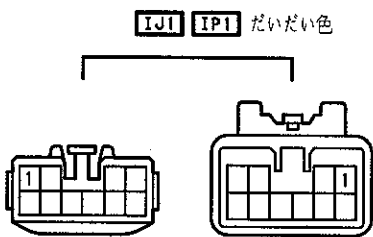
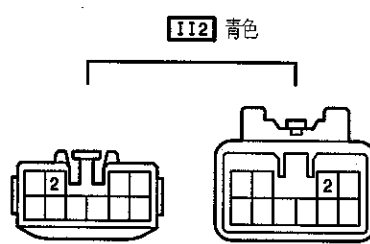
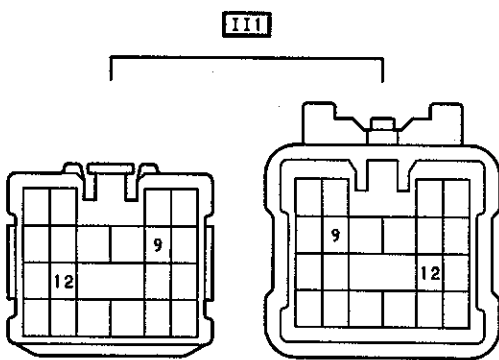
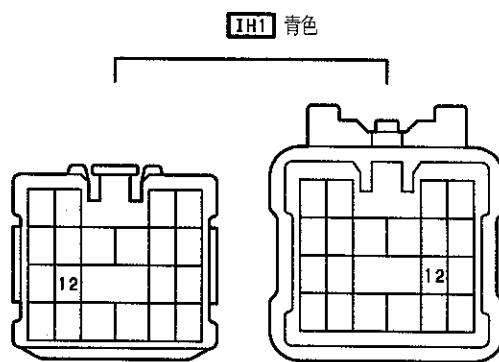
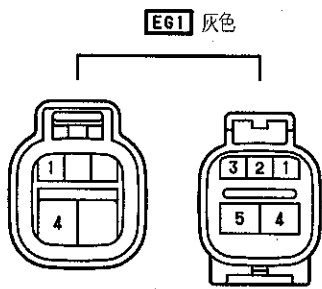
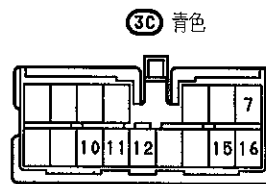
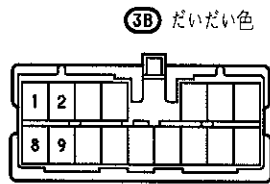
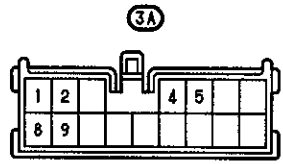
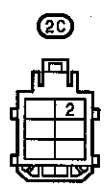
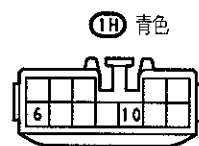
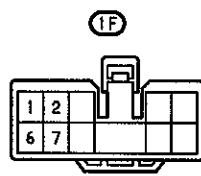
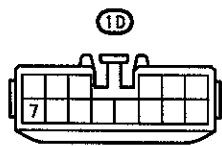
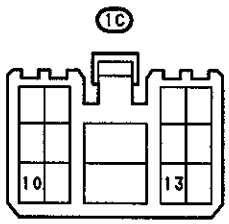

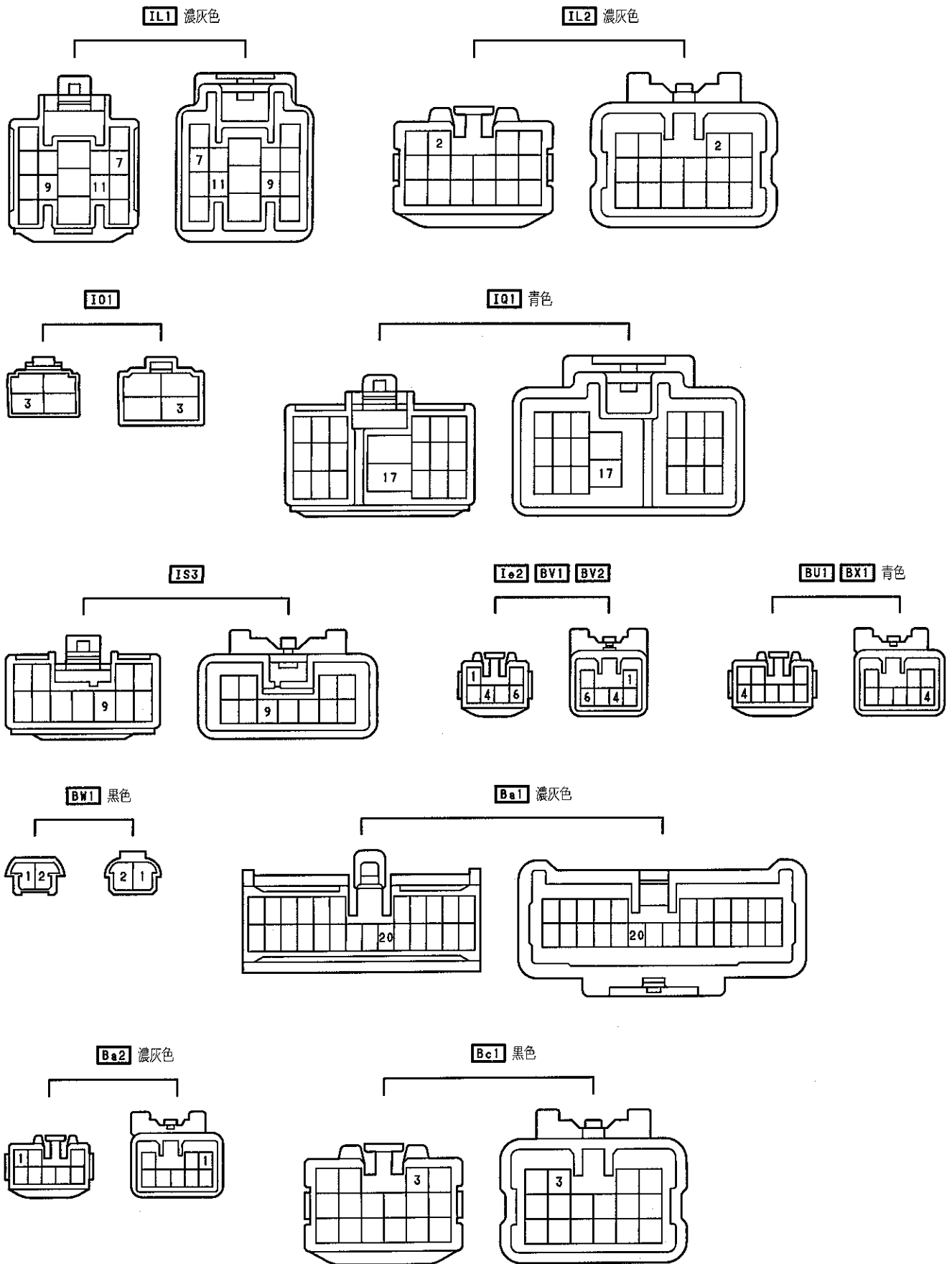

MEMO